

▶ FEATURES

- + Ships with Clean Air MERV 11 filter
- + Can be upgraded to Healthy Home MERV 13 filter with simple filter change
- + Minimal maintenance required — simply replace filter annually
- + Made of corrosion-resistant heavy gauge galvanized steel
- + Proprietary door design and Self-Seal™ filter design virtually eliminates air bypass, delivering MERV performance as rated
- + UL listed air cleaners, UL classified filters
- + Load rated up to 400 lbs.
- + 5-year warranty on cabinet from date of installation



▶ BENEFITS

- + Offers equipment protection from dust buildup, reducing profit-robbing callbacks
- + Assured system performance through low static pressure
- + Superior performance over one-inch filters — next to no bypass, longer filter life, traps more particles

PRODUCT SPECIFICATIONS

	Nominal Size (In Inches)	Shipping Weight	MERV 11				MERV 13							
			Replacement Filter	Resistance @ Airflow Volume (Inches w.c. @CFM)		Filter Carton Shipping Weight	Filtering Media Area	Replacement Filter	Resistance @ Airflow Volume (Inches w.c. @CFM)		Filter Carton Shipping Weight	Filtering Media Area		
Model 1110	16 x 20	13 lbs.	MODELS SHIPS WITH	Model 110	.06"@600 .10"@800	.14"@1000 .20"@1200	18 lbs.	22.2 sq. ft.	ALSO USES	Model 113	.11"@600 .16"@800	.22"@1000 .29"@1200	18 lbs.	22.2 sq. ft.
Model 1210	20 x 25	18 lbs.		Model 210	.04"@600 .06"@800 .08"@1000 .11"@1200	.13"@1400 .16"@1600 .19"@1800 .22"@2000	25 lbs.	28 sq. ft.		Model 213	.06"@600 .09"@800 .12"@1000 .15"@1200	.19"@1400 .23"@1600 .27"@1800 .31"@2000	25 lbs.	28 sq. ft.
Model 1310	20 x 20	15 lbs.		Model 310	.06"@600 .10"@800	.14"@1000 .19"@1200	19 lbs.	21.3 sq. ft.		Model 313	.09"@600 .13"@800	.17"@1000 .23"@1200	19 lbs.	21.3 sq. ft.
Model 1410	16 x 25	17 lbs.		Model 410	.05"@600 .07"@800 .09"@1000 .12"@1200	.15"@1400 .19"@1600 .22"@1800 .27"@2000	22 lbs.	24.5 sq. ft.		Model 413	.07"@600 .10"@800 .14"@1000 .17"@1200	.22"@1400 .26"@1600 .31"@1800 .37"@2000	22 lbs.	24.5 sq. ft.
Model 1910	25 x 20	18 lbs.		Model 910	.03"@400 .05"@600 .07"@800 .09"@1000	.12"@1200 .15"@1400 .18"@1600 .22"@1800 .27"@2000	28 lbs.	25.9 sq. ft.		Model 913	.04"@400 .07"@600 .10"@800 .13"@1000	.17"@1200 .21"@1400 .25"@1600 .30"@1800 .35"@2000	28 lbs.	25.9 sq. ft.

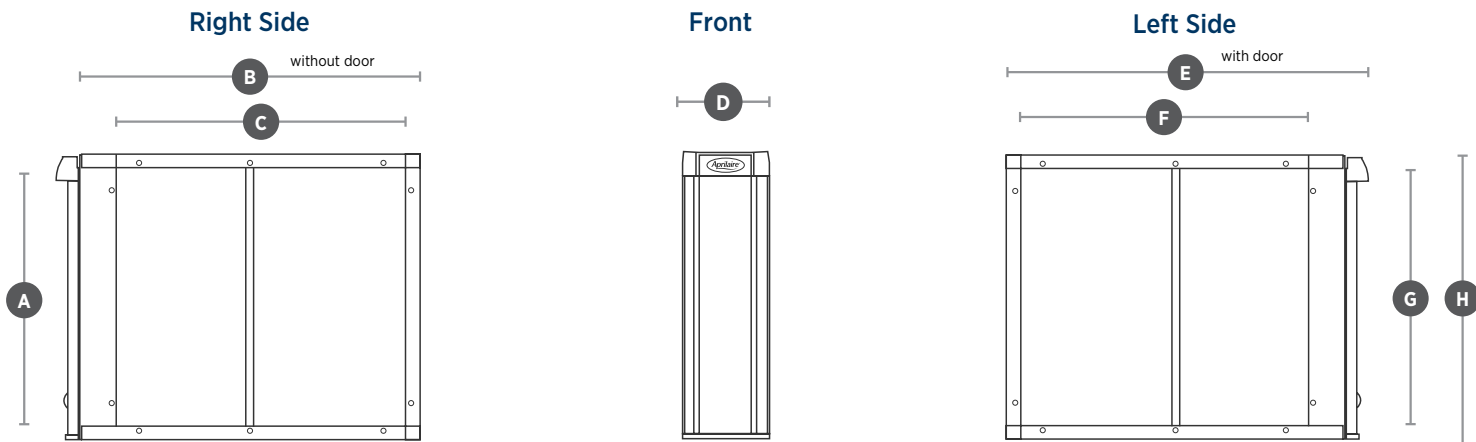

Dim.	Description	Model				
		1110	1210	1310	1410	1910
A	Inlet Opening Height	15 ⁷ / ₁₆ " (392mm)	19 ³ / ₄ " (502mm)	18 ¹ / ₈ " (459mm)	15 ⁷ / ₁₆ " (392mm)	22 ³ / ₄ " (578mm)
B	Outer Housing Depth without Door	20 ¹ / ₁₆ " (510mm)	25 ³ / ₈ " (645mm)	20 ¹ / ₁₆ " (510mm)	28 ¹ / ₁₆ " (713mm)	20 ¹ / ₁₆ " (510mm)
C	Inlet Opening Width	17 ³ / ₈ " (441mm)	21 ³ / ₁₆ " (538mm)	15 ⁷ / ₈ " (403mm)	23 ⁷ / ₈ " (606mm)	15 ⁷ / ₈ " (403mm)
D	Unit Width	6 ³ / ₄ " (171mm)	6 ³ / ₄ " (171mm)	6 ³ / ₄ " (171mm)	6 ³ / ₄ " (171mm)	6 ³ / ₄ " (171mm)
E	Outer Housing Depth with Door	22 ¹ / ₁₆ " (560mm)	27 ³ / ₈ " (695mm)	22 ¹ / ₁₆ " (560mm)	30 ¹ / ₁₆ " (764mm)	22 ¹ / ₁₆ " (560mm)
F	Outlet Opening Width	17 ³ / ₈ " (441mm)	21 ³ / ₁₆ " (538mm)	15 ⁷ / ₈ " (403mm)	23 ⁷ / ₈ " (606mm)	15 ⁷ / ₈ " (403mm)
G	Outlet Opening Height	15 ⁷ / ₁₆ " (392mm)	19 ³ / ₄ " (502mm)	18 ¹ / ₈ " (459mm)	15 ⁷ / ₁₆ " (392mm)	22 ³ / ₄ " (578mm)
H	Unit Height	17 ³ / ₄ " (451mm)	22 ¹ / ₁₆ " (560mm)	20 ³ / ₈ " (518mm)	17 ³ / ₄ " (451mm)	25 ¹ / ₁₆ " (637mm)

Replacement Filter

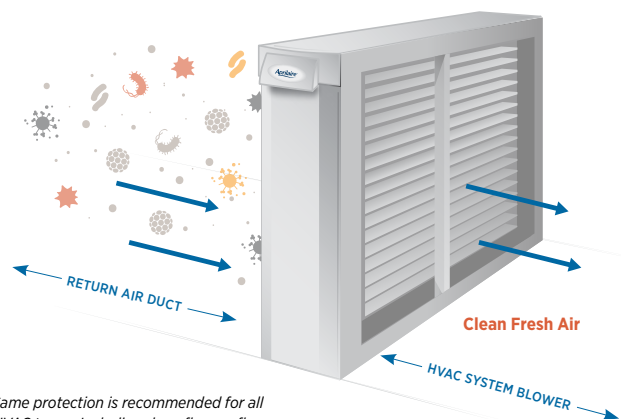

Same protection is recommended for all HVAC types. Including downflow, upflow and horizontal configurations.

REMOVAL EFFICIENCY (Based on Particle Size)			
	0.3-1.0 Microns	1.0-3.0 Microns	3.0-10 Microns
MERV 11	37%	67%	92%
MERV 13	63%	88%	93%

GENUINE Aprilaire Clean Air AIR FILTER			EFFICIENCY RATING MERV 11 1-YEAR LIFE	STOCK NO. 210 <small>Fits Aprilaire Purifier Models: 1210 1420 1220 1226 1226 1226 4200</small>
Ships With	MERV 11 PERFORMANCE	Model 1110	Filter Model 110	
		Model 1210	Filter Model 210	
		Model 1310	Filter Model 310	
		Model 1410	Filter Model 410	
		Model 1910	Filter Model 910	

GENUINE Aprilaire Healthy Home AIR FILTER			EFFICIENCY RATING MERV 13 1-YEAR LIFE	STOCK NO. 213 <small>Fits Aprilaire Purifier Models: 1210 1420 1220 1226 1226 1226 4200</small>
Ships With	MERV 13 PERFORMANCE	Model 1110	Filter Model 113	
		Model 1210	Filter Model 213	
		Model 1310	Filter Model 313	
		Model 1410	Filter Model 413	
		Model 1910	Filter Model 913	