

**PolyPro®**

**Polypropylene venting products for  
high-efficiency condensing  
appliance installations.**

**Listed to ULC-S636.**



## Specifications

### Applications

PolyPro is a polypropylene vent pipe for use with ANSI Category II and IV gas-burning appliances, including high-efficiency water heaters, condensing boilers and warm air furnaces. PolyPro is listed by Intertek to the ULC S636 standard in Canada as a Class IIA, IIB and IIC vent system suitable for exhaust temperatures up to 230°F / 110°C, and a maximum positive pressure of 15 in-w.c.

### Materials and Construction

Rigid pipe constructed of 2.2mm (minimum) thick polypropylene. Flex is double-wall polypropylene. EPDM or optional Viton Gaskets

### Clearances

0" clearance to combustibles for exhaust temperatures up to 194°F / 90°C, and 0" clearance for vertical installations up to exhaust temperatures of 230°F / 110°C and ¼" / 6mm clearance to combustibles for horizontal installations at exhaust temperatures up to 230°F / 110°C. PolyPro concentric vent system components, including concentric Horizontal Termination and Vertical Termination, are listed at 0" clearance to combustibles for exhaust temperatures up to 230°F / 110°C. Double Wall PolyPro provides 0" clearance to combustibles.

### Diameters

2" (60mm), 3" (80mm), 4" (100mm), 5" (130mm), 6" (150mm), and 8" (200mm).

### Listings

Listed with the appliance in the USA and Canada, check with appliance manufacturer. Intertek / ETL listed to ULC S636 Listed as a Class IIA, IIB, and IIC vent system.

PolyPro is approved by the Massachusetts Plumbers Board. Approval code G1-0811-42.



# PolyPro®

PolyPro and PVC/CPVC: PVC pipes are commonly used for venting water heaters, condensing boilers and warm air furnaces, yet PVC was never designed for such use. PolyPro is an engineered alternative for condensing gas appliances. Engineered for venting, it is easier and faster to install than PVC, saving the contractor time and money. Polypropylene has a higher operating temperature limit of 230°F/110°C (PVC is 149°F/65°C max and CPVC is 194°F/90°C). PolyPro is engineered with a condensation management system.

### Flex

PolyPro Flex through B Vent as a Chase: Retrofit venting for new, high-efficiency appliances. When replacing a mid-efficiency appliance with a new condensing 90+ appliance, you can use the existing B vent (any brand) as a chase for the new appliance with PolyPro. The perfect solution for utilizing the B Vent already in place, use the convenient pull cone to insert double-wall PolyPro Flex through the B Vent pipe and terminate in either a two pipe or single pipe system. At the other end is the unique B Vent/PolyPro Support Cap, allowing for the connection of flex to rigid PolyPro lengths and elbows to finish the installation.

### Terminations

DuraVent's concentric PolyPro vertical terminations are lab tested to handle harsh weather and remain icicle free in freezing temperatures. Air circulation and weather conditions like rain, wind and ice have the potential to reduce the efficiency of a unit's performance and the operation of its venting system.

### Double Wall

DW shells are offered separately, handling pipe lengths, elbows, and appliance connections. For installation, single wall PolyPro is inserted into the metal shell, which has a support disk inside. Adjustable DW sections are available if needed. The vent system is supported using typical means, including wall straps, elbow straps and roof or firestop supports. Vertical and Horizontal Terminations are available. Additionally, you can use adapters to transition from an M&G DuraVent / Security Chimney stainless vent systems, to DW PolyPro. This integration of vent systems gives you unmatched installation flexibility.



## Commercial & OEM Product Development

M&G DuraVent engineers are expertly skilled to develop venting components to OEM specs. To satisfy specific venting requirements, DuraVent has the experience to provide custom design, prototyping and testing of vent systems and components engineered to the demands of specific appliances.

## The PolyPro Commercial Difference

- Available in 5in. (130mm), 6in. (150mm) and 8in. (200mm) diameters.
- Completely smooth inner wall for optimal flow performance.
- Components designed for complete discharge of condensate.
- Design allows for system distance adjustment from the back of the appliance.
- Sizing services available to help in calculating required vent size.

## New & Improved Locking System

Incorporates a locking tab on the male end of the pipe and a revised locking band that slides over the tab, twists and firmly grasps the socket of the next pipe. This approach offers installers a number of important advantages including a secure mechanical connection (rather than relying on friction alone) and the ability to inspect the joint after installation for proper insertion depth.

The locking band is placed on the pipe, elbows and tees at the factory. Including the locking band(s) with the part will ensure the requirement for the listing is met. There is no need to remember to include separate locking bands on your order as before. All new parts with the upgraded locking system will have a new part number ending in "L".

To see the new PolyPro locking system, visit [duravent.com](http://duravent.com) and click on the link for the PolyPro Locking System video or scan the QR tag below with your smartphone.

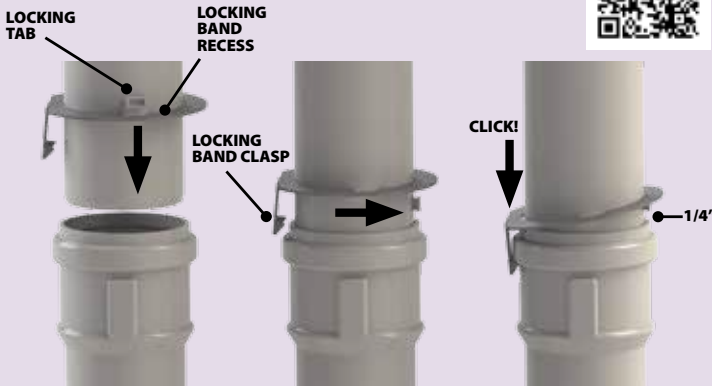

M&G DuraVent is dedicated to one thing: focusing on the design and manufacturing of venting products. As experts in this industry, our team is passionate about creating innovative, quality products. We invest in equipment with the latest technology to develop and test venting products that are engineered to one standard: excellence. All measuring equipment is calibrated to the same levels as used by testing agencies and are compliant with ISO 17025, the test-laboratory standard.



## Wind Tunnel Laboratory

The wind tunnel lab allows us to gather precise data with 270 degrees of measurement on terminations. All data is analyzed for product performance under rigorous conditions before going to market.

## Rain Testing

M&G labs test the vapor/moisture barrier of products by subjecting them to extreme rain and wind conditions. These tests are compliant with both the US and Canadian requirements as well as the stringent European standards.

## Climate Testing

M&G labs have developed a patented ice testing system in the climate room. Tests run to -4°F (-20°C). PolyPro vertical terminations are engineered to remain icicle free.

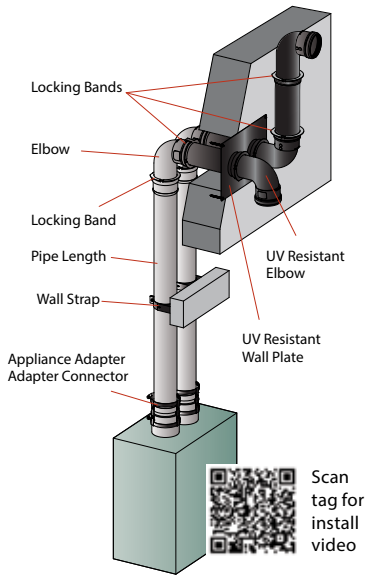

**Horizontal Twin Pipe Elbow Termination**

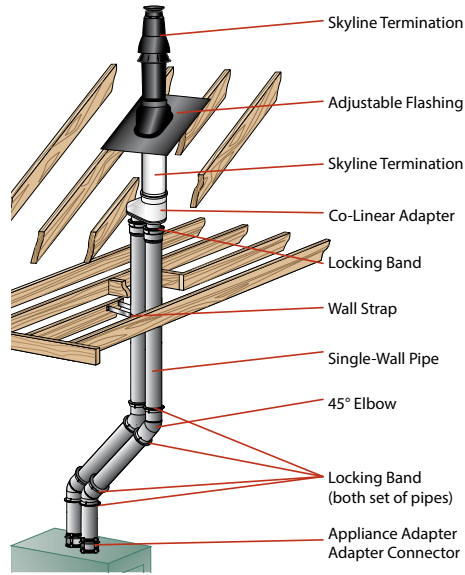

**Twin Pipe with Concentric Termination**

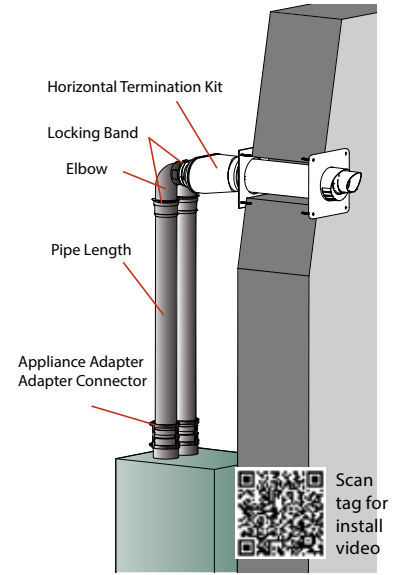

**Horizontal Twin Pipe Concentric**

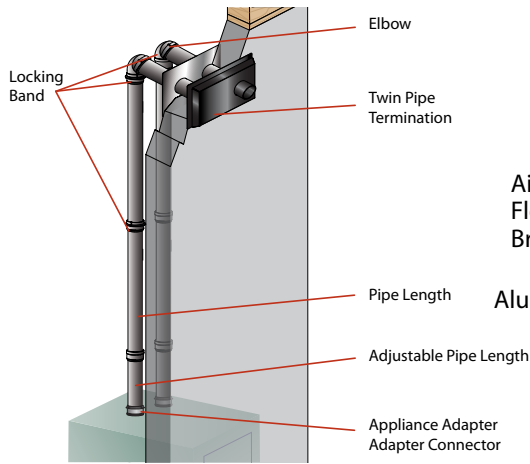

**Horizontal Twin Pipe Below Grade**

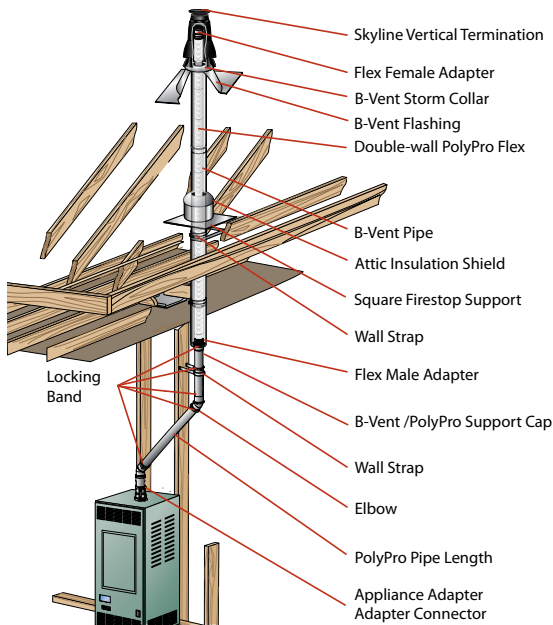

**Flex Through B vent as a Chase**

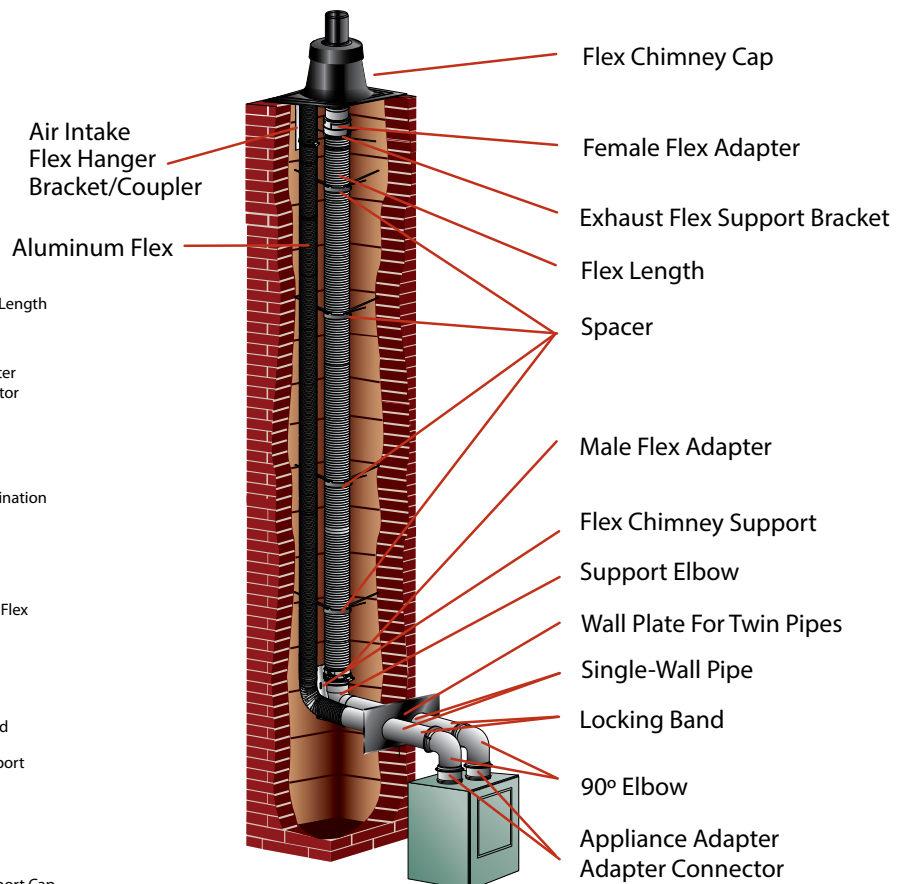

**Flex Through Chimney w/Air Intake**

See PolyPro Flex section for information on how to create your own air intake kit.



### Single-Wall Pipe

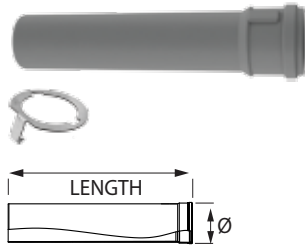

Use to vent condensing appliances. 2" (60mm) of overlap at the joint. Listed to ULC S636. Locking bands are required at all joint connections. Includes 1 Locking Band per each length .

SIZE	12"   305mm		36"   914mm		72"   1829mm	
	ORDER #	STOCK #	ORDER #	STOCK #	ORDER #	STOCK #
2"   60mm	2PPS-12L	810009667	2PPS-36L	810009669	2PPS-72L	810009671
3"   80mm	3PPS-12L	810009657	3PPS-36L	810009696	3PPS-72L	810009698
4"   100mm	4PPS-12L	810009723	4PPS-36L	810009725	4PPS-72L	810009727
5"   130mm	5PPS-12L	810009755	5PPS-36L	810009756	5PPS-72L	810009757
6"   150mm	6PPS-12L	810009772	6PPS-36L	810009774	6PPS-72L	810009776
SIZE	40"   1016mm		75"   1905mm			
	ORDER #	STOCK #	ORDER #	STOCK #		
8"   200mm	8PPS-40L	810009793	8PPS-75L	810009794		

### Black UV Resistant Single-Wall Pipe

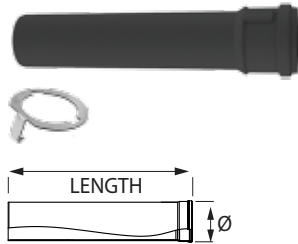

Use to vent condensing appliances. 2" (60mm) of overlap at the joint. Listed to ULC S636. Made of UV resistant polypropylene. Includes 1 Locking Band.

SIZE	12"   305mm		36"   914mm	
	ORDER #	STOCK #	ORDER #	STOCK #
2"   60mm	2PPS-12BL	810009668	2PPS-36BL	810009670
3"   80mm	3PPS-12BL	810009695	3PPS-36BL	810009697
4"   100mm	4PPS-12BL	810009724	4PPS-36BL	810009726
6"   150mm	6PPS-12BL	810009773	6PPS-36BL	810009775

### Adjustable Pipe

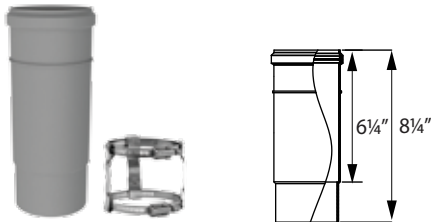

Use to add length to straight length of PolyPro pipe. Slips over any standard single-wall pipe length to form a telescoping pipe section. 4 1/2" (114mm) of adjustment. Adjustable pipe not available in 8" (200mm) diameter. Includes 1 Adapter Connector clamp.

SIZE	ORDER #	STOCK #	SIZE	ORDER #	STOCK #
2"   60mm	2PPS-08AL	810009674	5"   130mm	5PPS-08AL	810009759
3"   80mm	3PPS-08AL	810009702	6"   150mm	6PPS-08AL	810009778
4"   100mm	4PPS-08AL	810009731			

### Test Port



Use for combustion analysis testing without drilling holes into the vent system. Port cap is threaded for easy removal. Install immediately above the appliance. Includes 1 Locking Band.

SIZE	ORDER #	STOCK #	SIZE	ORDER #	STOCK #
2"   60mm	2PPS-TPL	810009690	5"   130mm	5PPS-TPL	810009769
3"   80mm	3PPS-TPL	810009718	6"   150mm	6PPS-TPL	810009789
4"   100mm	4PPS-TPL	810009751	8"   200mm	8PPS-TPL	810009805

### 45° Elbow

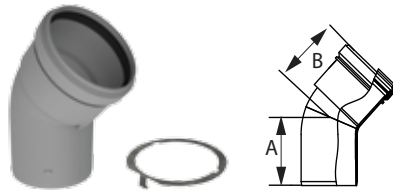

Offsets around obstructions as needed. Includes 1 Locking Band.

SIZE	ORDER #	STOCK #	A	B
2"   60mm	2PPS-E45L	810009675	2 7/8"   72.5mm	2 11/16"   69mm
3"   80mm	3PPS-E45L	810009703	2 7/8"   73mm	2 7/8"   73mm
4"   100mm	4PPS-E45L	810009733	2 13/16"   78mm	2 13/16"   78mm
5"   130mm	5PPS-E45L	810009760	3 3/4"   95mm	3 13/16"   98mm
6"   150mm	6PPS-E45L	810009781	3 13/16"   98mm	3 15/16"   101mm
8"   200mm	8PPS-E45L	810009798	4 7/16"   111mm	5 7/16"   131mm

### Black UV Resistant 45° Elbow



Offsets around obstructions as needed. Made of UV resistant polypropylene. May be used for terminations. Order Bird Guard Screen to protect opening when used as termination. Includes 1 Locking Band.

SIZE	ORDER #	STOCK #	A	B
2"   60mm	2PPS-E45BL	810009676	2 7/8"   73mm	2 11/16"   69mm
3"   80mm	3PPS-E45BL	810009704	2 7/8"   73mm	2 7/8"   73mm
4"   100mm	4PPS-E45BL	810009734	2 13/16"   78mm	2 1/2"   65mm

### 90° Elbow

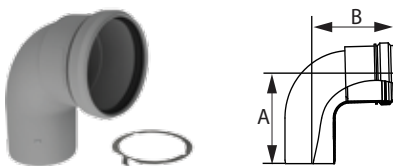

Offsets around obstructions as needed. Includes 1 Locking Band.

SIZE	ORDER #	STOCK #	A	B
2"   60mm	2PPS-E90L	810009677	4"   100mm	4"   100mm
3"   80mm	3PPS-E90L	810009658	4 5/16"   110mm	4 5/16"   110mm
4"   100mm	4PPS-E90L	810009735	4 1/2"   115mm	4 1/2"   115mm
5"   130mm	5PPS-E90L	810009761	6 3/4"   169mm	5 15/16"   152mm
6"   150mm	6PPS-E90L	810009782	7 1/4"   183mm	6 1/2"   166mm
8"   200mm	8PPS-E90L	810009799	8 15/16"   227mm	7 3/4"   195mm

### Black UV Resistant 90° Elbow



Offsets around obstructions as needed. Made of UV resistant polypropylene. May be used for terminations. Order Bird Guard Screen to protect opening when used as termination. Includes 1 Locking Band.

SIZE	ORDER #	STOCK #	A	B
2"   60mm	2PPS-E90BL	810009678	4"   100mm	4"   100mm
3"   80mm	3PPS-E90BL	810009705	4 5/8"   110mm	4 5/8"   110mm
4"   100mm	4PPS-E90BL	810009736	4 1/2"   115mm	4 1/2"   115mm
6"   150mm	6PPS-E90BL	810009783	7 1/4"   183mm	6 1/2"   166mm

### Black UV Resistant Extended 90° Elbow

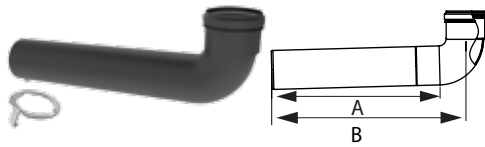

Made of UV resistant polypropylene. May be used for terminations. Order Bird Guard Screen to protect opening when used as termination. Includes 1 Locking Band.

SIZE	ORDER #	STOCK #	A	B
2"   60mm	2PPS-E90EBL	810009679	14"   358mm	16"   405mm
3"   80mm	3PPS-E90EBL	810009706	14 1/4"   360mm	16 5/8"   415mm
4"   100mm	4PPS-E90EBL	810009737	14 1/4"   360mm	16 1/2"   420mm

### Condensate Drain

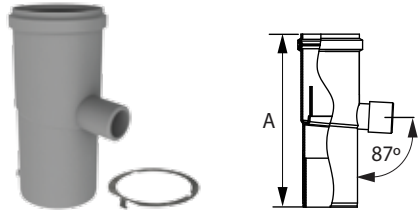

Use to remove corrosive condensates from within the vent system. 1-1/4" OD drain outlet. Includes 1 locking band. For 8" systems - use 8PPS-T with 8PPS-CD Tee Cap Drain.

SIZE	ORDER #	STOCK #	A	SIZE	ORDER #	STOCK #	A
2"   50mm	2PPS-CDL	810010347	7"   180mm	5"   130mm	5PPS-CDL	810010350	7"   180mm
3"   80mm	3PPS-CDL	810010348	7"   180mm	6"   150mm	6PPS-CDL	810010351	7"   180mm
4"   100mm	4PPS-CDL	810010349	7"   180mm				

### Tee Cap



Use cap on Tees, Condensate Drain or on other components where a cap is needed.

SIZE	ORDER #	STOCK #	SIZE	ORDER #	STOCK #
2"   60mm	2PPS-C	810004103	5"   130mm	5PPS-C	810004226
3"   80mm	3PPS-C	810004142	6"   150mm	6PPS-C	810004261
4"   100mm	4PPS-C	810004185	8"   200mm	8PPS-C	810004292

### Tee Cap w/Condensate Drain



Use cap on Tees, Condensate Drain or on other components where a cap is needed.

SIZE	ORDER #	STOCK #
8"   200mm	8PPS-CD	810004291

### Tee w/ Cap

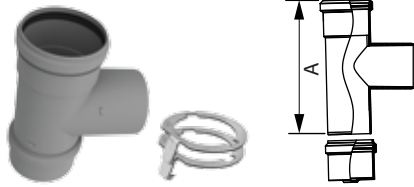

Use for a 90° offset or to combine connections. Includes 2 Locking Bands.

SIZE	ORDER #	STOCK #	A	SIZE	ORDER #	STOCK #	A
2"   60mm	2PPS-TL	810009687	7"   180mm	5"   130mm	5PPS-TL	810009767	11"   280mm
3"   80mm	3PPS-TL	810009659	7 7/8"   200mm	6"   150mm	6PPS-TL	810009787	11"   280mm
4"   100mm	4PPS-TL	810009748	8 11/16"   220mm	8"   200mm	8PPS-TL	810009803	13 13/16"   350mm

### Black UV Resistant Tee

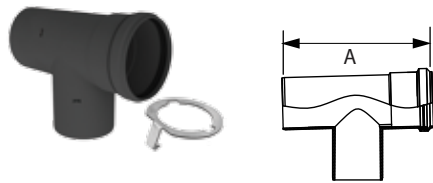

Use as a termination. Made of UV resistant polypropylene. Gasket not included. Includes 1 Locking Band.

SIZE	ORDER #	STOCK #	A
2"   60mm	2PPS-TBL	810009688	7"   180mm
3"   80mm	3PPS-TBL	810009716	7 7/8"   200mm
4"   100mm	4PPS-TBL	810009749	8 11/16"   220mm

### Black UV Resistant Termination Tee



Use as a termination. Manufactured with two female ends to accept Bird Screen on both ends. Use bird screen to protect openings. Made of UV resistant polypropylene. Includes 2 Bird Guard Screens & 1 Locking Band included.

SIZE	ORDER #	STOCK #
6"   150mm	6PPS-TTBL	810009790

### Black Wall Plate

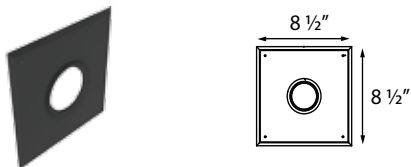

Use to trim wall penetration. Painted black metal with gasket.

SIZE	ORDER #	STOCK #	SIZE	ORDER #	STOCK #
2"   60mm	2PPS-WPB	810004112	4"   100mm	4PPS-WPB	810004195
3"   80mm	3PPS-WPB	810004152			

### Black Wall Plate for Twin Pipes

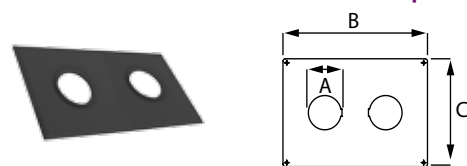

Use to trim wall penetration when using two pipes. Painted black metal with gaskets.

SIZE	ORDER #	STOCK #	A	B	C
2"   60mm	2PPS-WPT	810004113	2"   60mm	11 7/8"   302mm	8 1/2"   216mm
3"   80mm	3PPS-WPT	810004153	3"   80mm	11 7/8"   302mm	8 1/2"   216mm
4"   100mm	4PPS-WPT	810004196	4"   100mm	12 7/8"   327mm	8 1/2"   216mm



Tee w/Drain Cap

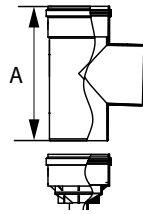

Use to remove corrosive condensates from within the vent system at the bottom of a vertical stack. 1-1/4" OD drain outlet. Includes 2 locking bands.

SIZE	ORDER #	STOCK #	SIZE	ORDER #	STOCK #
2"   60mm	2PPS-TCDL	810009689	5"   130mm	5PPS-TCDL	810009768
3"   80mm	3PPS-TCDL	810009717	6"   150mm	6PPS-TCDL	810009788
4"   100mm	4PPS-TCDL	810009750	8"   200mm	8PPS-TCDL	810009804

Reducer

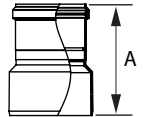

Use to transition the vent system to a smaller diameter. Includes 1 Adapter Connector clamp.

SIZE	ORDER #	STOCK #	A
3" - 2"   80 - 60mm	3PPS-R2L	810009714	5"   130mm
4" - 3"   100 - 80mm	4PPS-R3L	810009746	5"   130mm
5" - 4"   130 - 100mm	5PPS-R4L	810009764	7 5/8"   193mm
6" - 5"   150 - 130mm	6PPS-R5L	810009785	7 3/4"   197mm
8" - 6"   200 - 150mm	8PPS-R6L	810009801	5 15/16"   150mm

Increaser

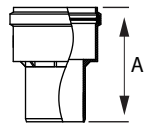

Use to transition the vent system to a larger diameter. Install in vertical orientation only. Includes 1 Adapter Connector clamp.

SIZE	ORDER #	STOCK #	A
2" - 3"   60 - 80mm	2PPS-X3L	810009694	4 5/16"   110mm
3" - 4"   80 - 100mm	3PPS-X4L	810009722	4 5/16"   110mm
4" - 5"   100 - 130mm	4PPS-X5L	810009754	4 5/16"   110mm
5" - 6"   130 - 150mm	5PPS-X6L	810009771	4 5/16"   110mm
6" - 8"   150 - 200mm	6PPS-X8L	810009792	5 3/4"   145mm

6" Fulton EDR 750-1500 to 6" PolyPro Appliance Adapter

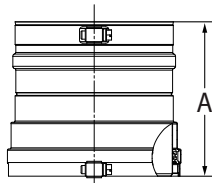

Use to connect 6" diameter PolyPro vent system to the Fulton EDR 750-1600 model appliance. No adapter connector and/or locking band required. Hose clamps on both ends.

SIZE	ORDER #	STOCK #	A
6"	6PPS-FULTEDR-6PPF	810010023	5.9"

### 8" Fulton EDR 2000 to 8" PolyPro Appliance Adapter

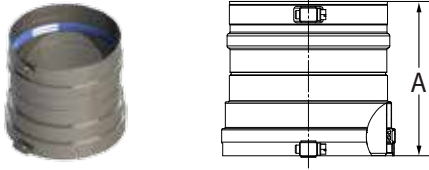

Use to connect 8" diameter PolyPro vent system to the Fulton EDR 2000 model appliance. No adapter connector and/or locking band required. Hose clamps on both ends.

SIZE	ORDER #	STOCK #	A
8"	8PPS-FULTEDR-8PPF	810010025	5.9"

### Appliance Adapter for PVC Pipe



Use to connect PolyPro vent system to an appliance outlet. Double female adapter - one end accepts PVC male pipe and the other accepts PolyPro male pipe. Locking Band is required on the female PP end.

SIZE	ORDER #	STOCK #
3"   80mm	3PPS-AD-M	810007169
4"   100mm	4PPS-AD-M	810007170

### Appliance Adapter for PVC Coupler



Use to adapt rigid PolyPro pipe length to the inside of the PVC/CPVC coupler or other plastic/metal appliance outlet. Must be used with Adapter Connector for flue gas. Includes 1 Adapter Connector clamp.

SIZE	ORDER #	STOCK #	SIZE	ORDER #	STOCK #
2"   60mm	2PPS-ADL	810009672	4"   100mm	4PPS-ADL	810009728
3"   80mm	3PPS-ADL	810009699			

### Female Appliance Adapter



Use to connect PolyPro to a nominal sized pipe with a smooth male end outlet. No adapter connector and/or Locking Band required. Hose clamps on both ends.

SIZE	ORDER #	STOCK #	A	B	C
3"   80mm	FSAAU3-3PP	810004171	3 1/5"   81mm	3"   80mm	5"   130mm
4"   100mm	FSAAU4-4PP	810004210	4"   100mm	4"   100mm	5"   130mm
6"   150mm	FSAAU6-6PP	810004283	5 15/16"   151mm	6"   150mm	5"   130mm
8"   200mm	FSAAU8-8PP	810004312	7 15/16"   199mm	8"   200mm	5"   130mm

### Male PVC Appliance Adapter

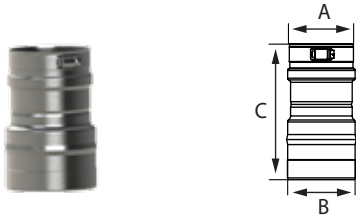

Use to connect PolyPro vent system to a standard stainless steel appliance outlet equipped with an integrated hose clamp and gasket. Must be used with Adapter Connector for flue gas, unless a clamp is supplied on the appliance outlet. Same O.D. as PVC.

SIZE	ORDER #	STOCK #	A	B	C
3" to 2"   80mm	3PPS-03PVC-2PPF	810007345	2 2/5"   61mm	3 1/2"   89mm	6"   150mm
3" to 3"   80mm	3PPS-03PVC-3PPF	810004167	3 3/16"   81mm	3 1/2"   89mm	6 13/16"   173mm
4"   100mm	4PPS-04PVC-4PPF	810004207	4"   102mm	4 1/2"   114mm	6 13/16"   173mm
6"   150mm	6PPS-06PVC-6PPF	810004281	5 3/16"   132mm	5 9/16"   141mm	6 13/16"   173mm
8"   200mm	8PPS-08PVC-8PPF	810004310	6"   152mm	6 5/8"   168mm	6 15/16"   176mm

### Female PVC Appliance Adapter

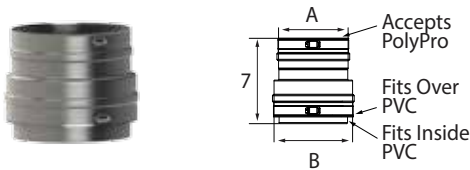

Use to directly connect PolyPro to a male PVC Pipe appliance outlet. Seals on the O.D. of the PVC pipe and has a clamp. No adapter connector and/or Locking Band required.

SIZE	ORDER #	STOCK #	A	B
5"   130mm	5PPS-05PVCF-5PPF	810004244	5"   130mm	5 11/16"   144mm
6"   150mm	6PPS-06PVCF-6PPF	810004280	5 15/16"   151mm	6 11/16"   170mm
8"   200mm	8PPS-08PVCF-8PPF	810004309	7 15/16"   132mm	7 7/8"   200mm

### FasNSeal Adapter

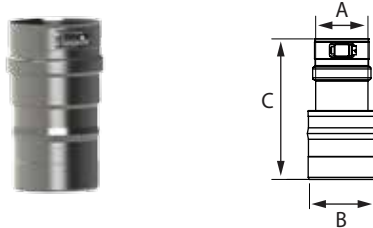

Use to transition from FasNSeal vent system to PolyPro vent system. Can be used as an appliance adapter or inline. No Locking Band required.

SIZE	ORDER #	STOCK #	A	B	C
3"   80mm	FSA-03M-2PPF	810004170	2 3/8"   60mm	3"   76mm	6 1/8"   156mm
3"   80mm	FSA-03M-3PPF	810004169	3 1/8"   79mm	3"   76mm	5 15/16"   151mm
4"   100mm	FSA-04M-4PPF	810004209	4"   100mm	4"   100mm	5 15/16"   151mm
5"   130mm	FSA-05M-5PPF	810004247	5 3/16"   132mm	5"   130mm	5 15/16"   151mm
6"   150mm	FSA-06M-6PPF	810007030	5 15/16"   151mm	6"   150mm	6"   150mm
7"   178mm	FSA-07M-6PPF	810004463	6 1/8"   156mm	6 3/16"   160mm	7"   178mm
8"   200mm	FSA-08M-8PPF	810007031	8"   200mm	8"   200mm	6"   150mm

### PolyProTo-FasNSeal Adapter



Use to transition from PolyPro vent system to FasNSeal vent system or to connect a metric appliance to FasNSeal. Can be used as an appliance adapter or inline. Includes 1 locking band.

SIZE	ORDER #	STOCK #	A	B	C
3"   80mm	3PPS-ADM-03FNSFL	810009701	3"   80mm	3 1/8"   79mm	3 13/16"   97mm
4"   100mm	4PPS-ADM-04FNSFL	810009730	4"   100mm	3 15/16"   99mm	5 15/16"   151mm
5"   130mm	5PPS-ADM-05FNSFL	810009758	5"   130mm	5 1/8"   131mm	5 15/16"   151mm
6"   150mm	6PPS-ADM-06FNSFL	810009777	6"   150mm	5 15/16"   151mm	7"   178mm
8"   200mm	8PPS-ADM-08FNSFL	810009795	8"   200mm	7 7/8"   199mm	7"   178mm

### Adapter Connector



Use to secure PolyPro pipe to PVC/CPVC coupler or appliance outlet. Universal size for 2-4 inch and 5-8 inch systems. M&G DuraVent requires its use with flue gas applications and recommends it with air intake applications.

SIZE	ORDER #	STOCK #	SIZE	ORDER #	STOCK #
2" - 4"	PPS-PAC	810004128	5" - 8"	PPS-PACL	810004243

### Wall Strap - Metal

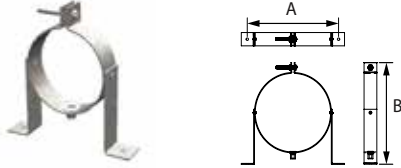

Use to support offsets and pipe used in vertical rise or horizontal runs as per installation instructions. Wall Strap legs can be rotated up to 360° for versatility. Accepts standard 1/4" all-thread. Available in galvanized or stainless steel metals. Note: Vent pipe must be supported at least every 10 feet (3m) vertically. Horizontal or sloped sections of vent pipe require a wall strap on each pipe section.

SIZE	GALVANIZED		A	B	SIZE	STAINLESS STEEL		A	B
	ORDER #	STOCK #				ORDER #	STOCK #		
2"   60mm	2PPS-WSM	810004110	3 5/8"   92mm	4 7/8"   124mm	2"   60mm	2PPS-WSM-SS	810004111	3 5/8"   92mm	4 7/8"   124mm
3"   80mm	3PPS-WSM	810004150	4 3/8"   112mm	5 1/4"   133mm	3"   80mm	3PPS-WSM-SS	810004151	4 3/8"   112mm	5 1/4"   133mm
4"   100mm	4PPS-WSM	810004193	5 1/8"   130mm	5 5/8"   143mm	4"   100mm	4PPS-WSM-SS	810004194	5 1/8"   130mm	5 5/8"   143mm
5"   130mm	5PPS-WSM	810004232	6 3/8"   162mm	6 3/4"   171mm	5"   130mm	5PPS-WSM-SS	810004233	6 3/8"   162mm	6 3/4"   171mm
6"   150mm	6PPS-WSM	810004266	7 1/8"   181mm	7 5/8"   194mm	6"   150mm	6PPS-WSM-SS	810004267	7 1/8"   181mm	7 5/8"   194mm
8"   200mm	8PPS-WSM	810004296	9 1/8"   232mm	9 5/8"   245mm	8"   200mm	8PPS-WSM-SS	810004297	9 1/8"   232mm	9 5/8"   245mm

### Locking Band



Use to secure two sections of uncut pipe together. Required to comply with ULC S636 listed installations.

SIZE	ORDER #	STOCK #	SIZE	ORDER #	STOCK #
2"   60mm	2PPS-LB2	810009654	5"   130mm	5PPS-LB2	810009914
3"   80mm	3PPS-LB2	810009655	6"   150mm	6PPS-LB2	810009915
4"   100mm	4PPS-LB2	810009656	8"   200mm	8PPS-LB2	810009916

### Locking Band Clamp

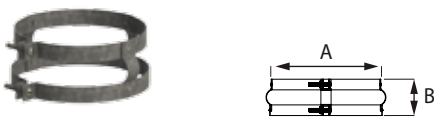

Use for connecting cut sections of pipe together. Also convenient for connection pipe sections used in extended vertical installations.

SIZE	ORDER #	STOCK #	A	B
2"   60mm	2PPS-LBC	810007146	2 3/8"   60mm	2 1/2"   64mm
3"   80mm	3PPS-LBC	810007147	3 1/8"   80mm	2 1/2"   64mm
4"   100mm	4PPS-LBC	810007148	4"   100mm	2 1/2"   64mm
5"   130mm	5PPS-LBC	810004242	5 1/8"   130mm	2 1/2"   64mm
6"   150mm	6PPS-LBC	810004278	6 1/8"   156mm	2 1/2"   64mm
8"   200mm	8PPS-LBC	810004306	8 1/8"   207mm	2 1/2"   64mm

### Firestop Spacer

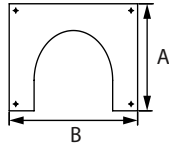
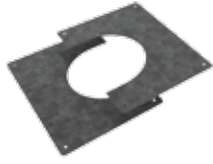

Use when penetrating floor levels. Two piece design for easier installation.

SIZE	SINGLE-WALL PIPE		A	B
	ORDER #	STOCK #		
2"   60mm	2PPS-FSS	810004115	4"   100mm	7"   178mm
3"   80mm	3PPS-FSS	810004155	4"   100mm	7"   178mm
4"   100mm	4PPS-FSS	810004198	4"   100mm	7"   178mm
5"   130mm	5PPS-FSS	810004234	8 1/8"   206mm	10"   254mm
6"   150mm	6PPS-FSS	810004269	7 3/4"   197mm	9 3/4"   248mm
8"   200mm	8PPS-FSS	810004298	10 1/2"   267mm	12 3/4"   324mm
SIZE	CONCENTRIC PIPE		A	B
	ORDER #	STOCK #		
2"   60mm	2PPS-FS	810004114	7"   178mm	8 3/4"   223mm
3"   80mm	3PPS-FS	810004154	7 7/8"   200mm	9 7/8"   251mm
4"   100mm	4PPS-FS	810004197	7 7/8"   200mm	9 7/8"   251mm

### Flat Roof Flashing

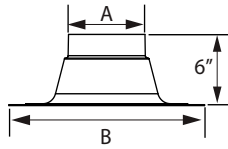

Use to weather-proof the penetration of vent pipe through the roof. For concentric pipe only.

SIZE	SINGLE-WALL PIPE		A	B
	ORDER #	STOCK #		
5"   130mm	5PPS-FF	810007171	5 1/2"   140mm	--
6"   150mm	6PPS-FF	810004268	6 1/4"   160mm	--
8"   200mm	8PPS-FF	810004302	8 1/4"   210mm	--
SIZE	CONCENTRIC PIPE		A	B
	ORDER #	STOCK #		
2"   60mm	2PPS-FF	810004116	4 5/8"   120mm	13 3/4"   350mm
3"   80mm	3PPS-FF	810004156	5 1/2"   140mm	15 5/16"   390mm
4"   100mm	4PPS-FF	810004199	6 1/4"   170mm	17"   430mm

### Adjustable Roof Flashing

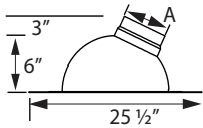

Use to weather proof penetration of vent through the roof. For concentric pipe. Made of aluminum. Adjusts from 0/12 to 5/12.

SIZE	CONCENTRIC PIPE		A
	ORDER #	STOCK #	
2" x 4"   60 - 100mm	2PPS-F5	810004117	4"   100mm
3" x 5"   80 - 130mm	3PPS-F5	810004157	5"   130mm
4" x 6"   100 - 150mm	4PPS-F5	810004200	6"   150mm

### Steep Roof Flashing

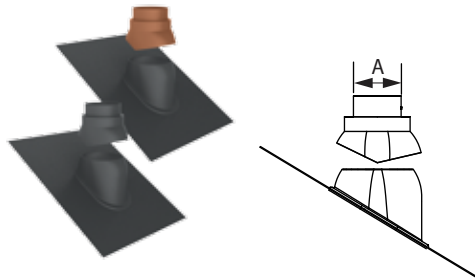

Use to weather proof penetration of vent through the roof. For concentric pipe. Made of polypropylene. Adjusts from 5/12 to 12/12. Black or terra-cotta. UV resistant.

SIZE	BLACK		A
	ORDER #	STOCK #	
2" x 4"   60 - 100mm	2PPS-F12	810004118	4"   100mm
3" x 5"   80 - 130mm	3PPS-F12	810004158	5"   130mm
4" x 6"   100 - 150mm	4PPS-F12	810004201	6"   150mm
SIZE	TERRA-COTTA		A
	ORDER #	STOCK #	
2" x 4"   60 - 100mm	2PPS-F12-TC	810004119	4"   100mm
3" x 5"   80 - 130mm	3PPS-F12-TC	810004159	5"   130mm
4" x 6"   100 - 150mm	4PPS-F12-TC	810004202	6"   150mm

### Twin Pipe Termination

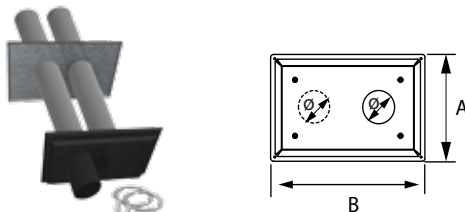

Use to terminate horizontally with two single-wall PolyPro pipes for intake and exhaust. Simple design ensures adequate separation of intake air from exhaust. Termination is painted black. Includes black UV resistant polypropylene exhaust nozzle equipped with Bird Screen, interior wall plate, and two 12" pipe lengths. Includes 2 Locking Bands.

SIZE	ORDER #	STOCK #	A	B
2"   60mm	2PPS-HTPL	810009685	8 1/2"   216mm	11 7/8"   302mm
3"   80mm	3PPS-HTPL	810009713	8 1/2"   216mm	11 7/8"   302mm
4"   100mm	4PPS-HTPL	810009745	8 1/2"   216mm	12 1/4"   311mm

### Single Horizontal Termination



Use to terminate horizontally with one single-wall PolyPro pipe. Termination and wall plate can be rotated to suit application. Elbow is UV resistant black with bird screen. Also includes interior wall plate, and 14" length of pipe. Includes 1 Locking Band.

SIZE	ORDER #	STOCK #
2"   60mm	2PPS-HSTL	810009684
3"   80mm	3PPS-HSTL	810009712

### Lochinvar Horizontal Termination Kit



Use to adapt PolyPro to the IpeX 636 low profile termination. Kit includes 14" pipe welded to an adapter and metal backing plate. Check with appliance manufacturer for approval. (Outer IPEX termination cap not included. Supplied by others.) Includes 1 Locking Band.

SIZE	ORDER #	STOCK #	A	B
2"   60mm	2PPS-HLKL	810009683	14 3/16"   360mm	8 5/8"   220mm
3"   80mm	3PPS-HLKL	810009711	14 3/16"   360mm	8 5/8"   220mm
4"   100mm	4PPS-HLKL	810009743	14 3/16"   360mm	8 5/8"   220mm

## Vertical Termination Cap Kit - Concentric

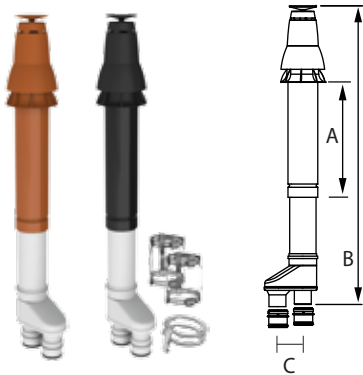

Use for concentric vertical terminations. Includes 2 appliance adapters and co-linear adapter. Black or terra-cotta cap. UV resistant. No storm collar required when installed with factory PolyPro flashing. Includes 2 Locking Bands and 2 Adapter Connector clamps.

SIZE	BLACK		A	B	C
	ORDER #	STOCK #			
2" x 4"   60 x 100mm	2PPS-VKL	810009692	18"   460mm	50 1/4"   1280mm	4 3/4"   121mm
3" x 5"   80 x 125mm	3PPS-VKL	810009720	23"   580mm	53 1/4"   1354mm	4 3/4"   121mm
4" x 6"   100 x 150mm	4PPS-VKL	810009752	23"   580mm	68 1/4"   1735mm	5 1/2"   140mm
SIZE	TERRA-COTTA		A	B	C
	ORDER #	STOCK #			
2" x 4"   60 x 100mm	2PPS-VK-TCL	810009693	18"   460mm	50 1/4"   1280mm	4 3/4"   121mm
3" x 5"   80 x 125mm	3PPS-VK-TCL	810009721	23"   580mm	53 1/4"   1354mm	4 3/4"   121mm
4" x 6"   100 x 150mm	4PPS-VK-TCL	810009753	23"   580mm	68 1/4"   1735mm	5 1/2"   140mm

## Horizontal Termination Kit - Concentric

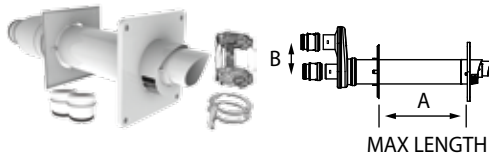

Use for concentric horizontal terminations. Includes 2 appliance adapters, white wall plate, white firestop, and co-linear adapter. White Termination with Bird Guard Screen. UV resistant. Inner plate is 8 5/8" (220mm) square, outer plate is 9 7/16" (240mm) square for all flue sizes. Includes 2 Locking Bands and two Adapter Connector clamps. Adapters included to transition from PVC appliance outlet to twin pipe PolyPro.

SIZE	ORDER #	STOCK #	A	B
2" - 4"   60 - 100mm	2PPS-HKL	810009682	13 3/4"   350mm	4 3/4"   121mm
3" x 5"   80 - 125mm	3PPS-HKL	810009710	13"   330mm	4 3/4"   121mm
4" x 6"   100 - 150mm	4PPS-HKL	810009742	13 3/4"   350mm	5 1/2"   140mm

## Bird Guard Screen



Use to protect venting system from birds and rodents. Spring-loaded design inserts within female end of pipe in place of gasket. Stainless steel.

SIZE	ORDER #	STOCK #	SIZE	ORDER #	STOCK #
2"   60mm	2PPS-BG	810004341	4"   100mm	4PPS-BG	810004367
3"   80mm	3PPS-BG	810004355	6"   150mm	6PPS-BG	810004276

## EPDM Replacement Gasket



Use as a replacement gasket for rigid PolyPro products. Available in packs of 12 for sizes 2" - 4". Available in packs of 6 for sizes 5" - 8".

SIZE	ORDER #	STOCK #	SIZE	ORDER #	STOCK #
2"   60mm	2PPS-GA	810004124	5"   130mm	5PPS-GA	810004237
3"   80mm	3PPS-GA	810004164	6"   150mm	6PPS-GA	810004272
4"   100mm	4PPS-GA	810004204	8"   200mm	8PPS-GA	810004303

### Viton Replacement Gasket



Alternative gasket material for oil fuel appliance applications. Available in packs of 12 for sizes 2" - 4". Available in packs of 6 for sizes 5" - 8".

SIZE	ORDER #	STOCK #	SIZE	ORDER #	STOCK #
2"   60mm	2PPS-GAV	810004126	5"   130mm	5PPS-GAV	810004238
3"   80mm	3PPS-GAV	810004165	6"   150mm	6PPS-GAV	810004273
4"   100mm	4PPS-GAV	810004205	8"   200mm	8PPS-GAV	810004304



# PolyPro Commercial Venting Components

## Vertical Termination for Commercial Systems

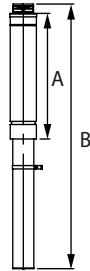

Exhaust termination for vertical through-the-roof applications. PolyPro pipe is protected by a sturdy outer metal pipe and integrated cap. Painted with a durable, powder coated black finish. Includes support hardware, including 1 Locking Band.

To complete vertical termination for commercial systems, installation requires (1) variable pitch roof flashing, (1) support clamp, and (1) storm collar.

SIZE	ORDER #	STOCK #	A	B	O.D.
5"   130mm	5PPS-VTML	810009770	29"   745mm	62"   1575mm	6 3/8"   162mm
6"   150mm	6PPS-VTML	810009791	29"   741mm	62"   1575mm	7 1/4"   184mm
8"   200mm	8PPS-VTML	810009806	32"   800mm	63"   1600mm	9 1/8"   232mm

## Variable Pitch Roof Flashing

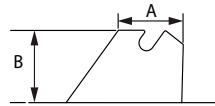

Use to weather-proof the penetration of vent pipe through the roof. For use with VTM. For pitches of 0/12 - 9/12. Made of stainless steel.

SIZE	ORDER #	STOCK #	A	B
5"   130mm	FSVPF5	810003241	7"	7"
6"   150mm	FSVPF6	810003295	8"	7"
8"   200mm	FSVPF8	810003383	9"	7"

## Support Clamp

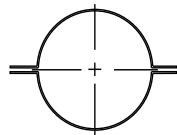

Use to position the Vertical Termination for Commercial Systems (VTM's) to the variable pitch roof flashing. The clamp is upsized one diameter to fit around the black metal outer pipe. The support claim rests in notched groove of variable pitch roof flashing.

SIZE	ORDER #	STOCK #	A
5"   130mm	FSCL6	810003288	1 1/2"
6"   150mm	FSCL7	810003332	1 1/2"
8"   200mm	FSCL9	810003414	1 1/2"

## Storm Collar



Clamps to black metal pipe covering support clamp and creating a weather tight seal above the flashing. For use with VTM.

SIZE	ORDER #	STOCK #
5"   130mm	FSCPP5	810007172
6"   150mm	FSCPP6	810007173
8"   200mm	FSCPP8	810007174

## Horizontal Termination for Commercial Systems

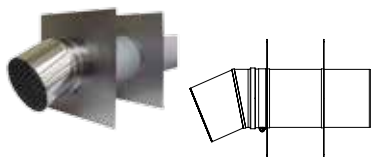

Use for through-the-wall horizontal terminations. Includes 23 degree termination elbow with integrated bird screen, inner and outer wall plates, and clamp for connecting to PolyPro pipe. No locking band is required. All components are stainless steel.

SIZE	ORDER #	STOCK #
4"   100mm	4PPS-HSTSL	810009744
5"   130mm	5PPS-HSTL	810009763
6"   150mm	6PPS-HSTL	810009784
8"   200mm	8PPS-HSTL	810009800

# PolyPro Double-Wall Components

## Pipe

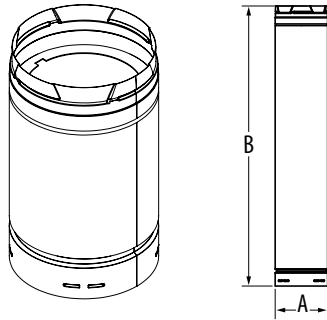

Galvanized outer jacket can be used as a conduit for single-wall PolyPro pipe. In exterior applications, provides protection from impact and UV light. Also provides some insulation value for use in colder climates. Can be field-painted if desired. Simple twist-lock assembly. To calculate installed length, subtract 1 1/2" for each joint. Includes internal metal support ring. PolyPro pipe sold separately.

SIZE	ORDER #	STOCK #	A	B
5"   130mm	5PPS-12DW	810009348	6 5/8"	12"
5"   130mm	5PPS-36DW	810009349	6 5/8"	36"
5"   130mm	5PPS-72DW	810009350	6 5/8"	72"
6"   150mm	6PPS-12DW	810009353	7 5/8"	12"
6"   150mm	6PPS-36DW	810009354	7 5/8"	36"
6"   150mm	6PPS-72DW	810009355	7 5/8"	72"
8"   200mm	8PPS-40DW	810009358	10"	40"
8"   200mm	8PPS-75DW	810009359	10"	75"

## Telescoping Pipe

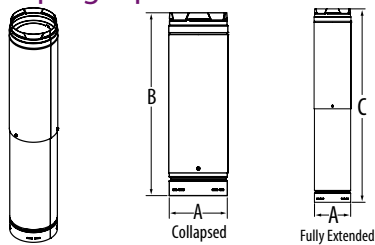

Matching telescoping section for galvanized outer jacket can be used to help achieve specific offset length or stack height. Minimum and maximum lengths vary according to diameter selected.

SIZE	ORDER #	STOCK #	A	B	C
5"   130mm	5PPS-36DWA	810009926	6 5/8"	21"	35 3/8"
6"   150mm	6PPS-36DWA	810009927	7 5/8"	21"	35 3/8"
8"   200mm	8PPS-40DWA	810009928	10"	24"	37 7/8"

## Appliance Adapter

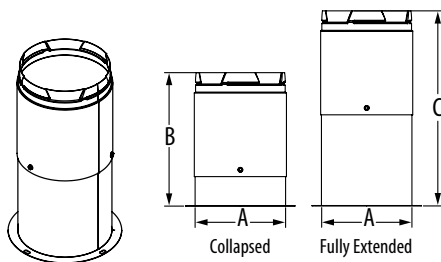

Adjustable Adapter with flange for galvanized outer jacket. Flange attaches to appliance cabinet with supplied screws. To calculate installed length, subtract 1 1/2" for each joint.

SIZE	ORDER #	STOCK #	A	B	C
5"   130mm	5PPS-ADDW	810009929	6 5/8"	9 3/4"	14 1/4"
6"   150mm	6PPS-ADDW	810009930	7 5/8"	9 3/4"	14 1/4"
8"   200mm	8PPS-ADDW	810009931	10"	9 3/4"	14 1/4"

### 90° Elbow

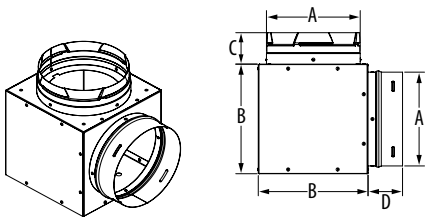

Galvanized outer jacket 90 degree elbow. Includes metal support ring. To calculate installed length, subtract 1 1/2" for each joint.

SIZE	ORDER #	STOCK #	A	B	C	D
5"   130mm	5PPS-E90DW	810009352	6 5/8"	7 3/4"	2 1/4"	2 1/2"
6"   150mm	6PPS-E90DW	810009357	6 5/8"	8 3/4"	2 1/4"	3 1/8"
8"   200mm	8PPS-E90DW	810009361	10"	11 1/4"	2 3/8"	3"

### 45° Elbow

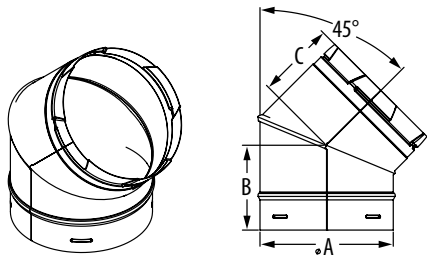

Galvanized outer jacket 45 degree elbow. Includes metal support ring. To calculate installed length, subtract 1 1/2" for each joint.

SIZE	ORDER #	STOCK #	A	B	C
5"   130mm	5PPS-E45DW	810009351	6 5/8"	4 1/4"	3 7/8"
6"   150mm	6PPS-E45DW	810009356	7 5/8"	4"	3 3/8"
8"   200mm	8PPS-E45DW	810009360	10"	4 1/2"	4 3/8"

### Wall Strap

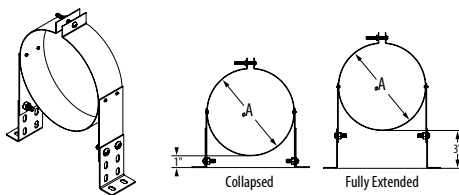

Use in interior or exterior installations to add lateral support to PolyPro DW Pipe. Adjusts to provide a 1" - 3" clearance to combustibles and maintain proper slope. Additional clearance can be increased with optional PPS-WSMDW-EXT.

SIZE	ORDER #	STOCK #	A
5" x 6"   130 - 150mm	5PPS-WSMDW	810009917	6 5/8"
6" x 7"   150 - 175mm	6PPS-WSMDW	810009918	7 5/8"
8" x 10"   200 - 254mm	8PPS-WSMDW	810009919	10"

### Wall Strap Extension

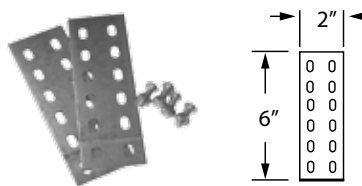

Use with Wall-Strap if additional mounting clearances or slope is required. Universal design fits all sizes.

SIZE	ORDER #	STOCK #
5" - 8"   130 - 200mm	PPS-WSMDW-EXT	810010086

### Elbow Strap

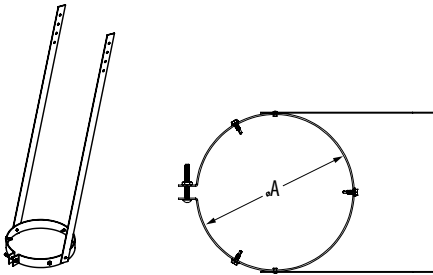

Used to support galvanized outer jacket when 45° elbows are used for offset purposes.

SIZE	ORDER #	STOCK #	A
5"   130mm	5PPS-ESDW	810009947	6 5/8"
6"   150mm	6PPS-ESDW	810009948	7 5/8"
8"   200mm	8PPS-ESDW	810009949	10"

### Adjustable Roof Flashing

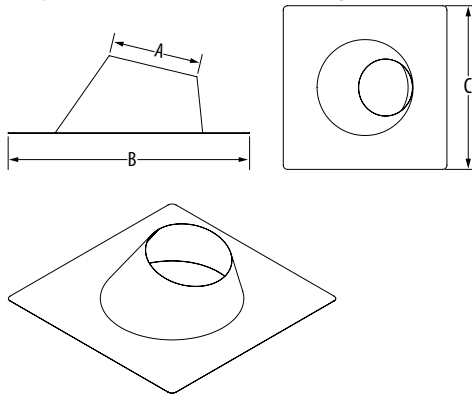

Use to to weather-proof the penetration of the galvanized outer jacket through the roof. Made of galvalume.

SIZE	FLASHING		
	ORDER #	STOCK #	PITCH
5"   130mm	5PPS-FDW	810009923	0/12 - 6/12
6"   150mm	6PPS-FDW	810009924	
8"   200mm	8PPS-FDW	810009925	
SIZE	FLASHING STEEP ROOF		
	ORDER #	STOCK #	PITCH
5"   130mm	5PPS-FSRDW	810009932	7/12 - 12/12
6"   150mm	6PPS-FSRDW	810009933	
8"   200mm	8PPS-FSRDW	810009934	

### Storm Collar

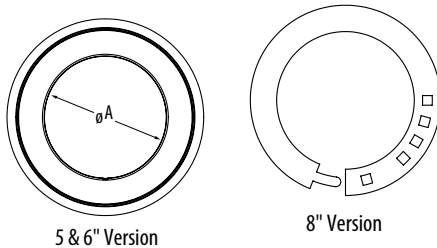

Used to maintain a weather tight, resistant seal between the galvanized outer jacket and flashing.

SIZE	ORDER #	STOCK #	A
5"   130mm	5PPS-SCDW	810009941	6 5/8"
6"   150mm	6PPS-SCDW	810009942	7 5/8"
8"   200mm	8PPS-SCDW	810009943	10"

### Firestop Spacer

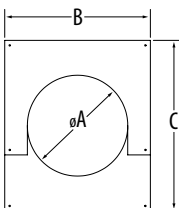

Use when penetrating walls or floor levels. Two piece design for easier installation.

SIZE	SPACER HZ				
	ORDER #	STOCK #	A	B	C
5"   130mm	5PPS-FSSDW	810010078	6 3/4"	12 5/8"	13 3/4"
6"   150mm	6PPS-FSSDW	810010079	7 3/4"	12 5/8"	14 5/8"
8"   200mm	8PPS-FSSDW	810010080	10 1/8"	14 5/8"	17 1/8"

### Firestop Support

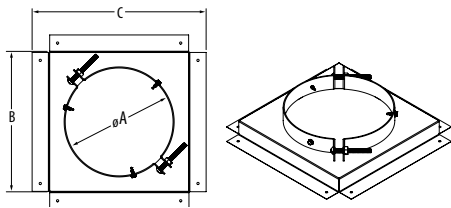

Use when penetrating floor levels with Double-Wall PolyPro and provide support at the ceiling level. Includes clamp that supports and prevents pipe sections from slipping down.

SIZE	SUP. ASSEMBLY				
	ORDER #	STOCK #	A	B	C
5"   130mm	5PPS-FSDW	810009920	6 5/8"	8 5/8"	10 3/4"
6"   150mm	6PPS-FSDW	810009921	7 5/8"	9 5/8"	11 3/4"
8"   200mm	8PPS-FSDW	810009922	10"	12"	14 1/8"

### Roof Support

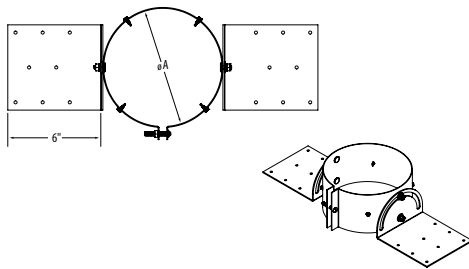

Used to support galvanized outer jacket and PolyPro vent within at the roof level. Adjustable to different roof pitches. Ideal for cathedral ceilings.

SIZE	ORDER #	STOCK #	A
5"   130mm	5PPS-RSDW	810010339	6 5/8"
6"   150mm	6PPS-RSDW	810010340	7 5/8"
8"   200mm	8PPS-RSDW	810010341	10"

### Horizontal Trim Plate

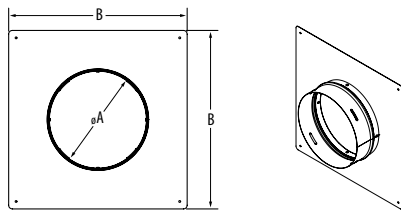

Used to trim interior wall penetration and transition from Double-Wall PolyPro (interior) to single wall pipe or Horizontal Termination (exterior). Includes built-in female twist-lock connection.

SIZE	ORDER #	STOCK #	A	B
5"   130mm	5PPS-HSTDW	810010075	6 5/8"	12"
6"   150mm	6PPS-HSTDW	810010076	7 5/8"	12"
8"   200mm	8PPS-HSTDW	810010077	10"	14"

### Vertical Termination

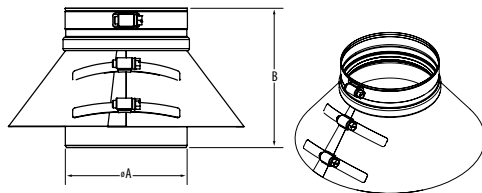

Use to vertically terminate a Double-Wall PolyPro system. Includes a AL29-4C stainless steel termination pipe with collar.

SIZE	ORDER #	STOCK #	A	B
5"   130mm	5PPS-VTDW	810009938	5 1/8"	6"
6"   150mm	6PPS-VTDW	810009939	5 7/8"	7"
8"   200mm	8PPS-VTDW	810009940	7 7/8"	7"

# PolyPro Flex Venting Components

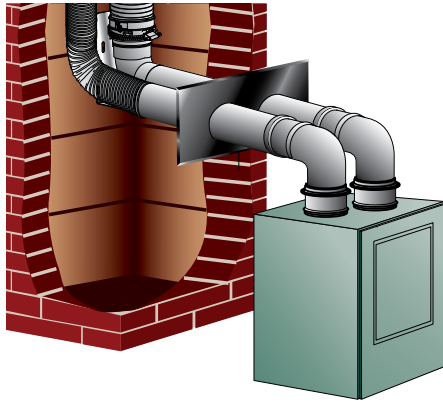

## Need An Air Intake Solution? Create Your Own Kit

Order DuraFlex AL length, Hanger Bracket, Coupler and Wall Plate for Twin Pipe. (2" Air intake will require a 2"-3" Increaser: 2PPS-X3)

- (1) DuraFlex AL Length: DFA-25, DFA-35, or DFA-50
- (1) Hanger Bracket: DFA-FCB
- (1) Coupler: DFA-FCP
- (1) Wall Plate for Twin Pipe: PPS-WPT

### Flex Chimney Lining Kit



Use for a vertical flex lining system. Includes black, UV resistant chimney cap, rigid flue vent, flex support bracket, 4 spacers in 3" & 4" kits, male and female flex adapters with gaskets, extended support elbow, wall plate, appliance adapter, Locking Band, and Adapter Connector clamp. Flex sold separately.

SIZE	ORDER #	STOCK #
2"   60mm	2PPS-FKL	810009681
3"   80mm	3PPS-FKL	810009707
4"   100mm	4PPS-FKL	810009738
5"   130mm	5PPS-FKL	810009762

### Chimney Cap

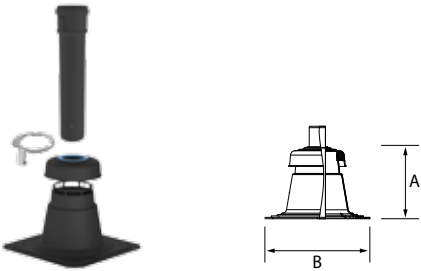

Use to vertically terminate a flex system. Black, UV resistant chimney cap with rigid steel flue vent. Includes 1 Locking Band.

SIZE	ORDER #	STOCK #	A	B
2"   60mm	2PPS-FCTL	810009680	9 3/4"	15 1/4"
3"   80mm	3PPS-FCTL	810009810	9 3/4"	15 1/4"
4"   100mm	4PPS-FCTL	810009811	9 3/4"	15 1/4"
5"   130mm	5PPS-FCTL	810009812	7 3/4"	15 3/4"

### Vertical Flex Termination Cap

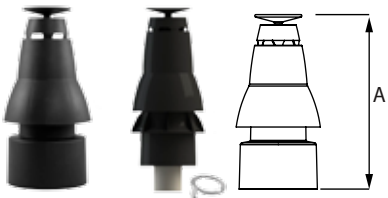

Use to vertically terminate a flex system when using the B-vent retrofit adapters. Includes male and female flex adapters and gaskets. Black, UV resistant. Match the termination size with flex diameter. 3" version includes 1 Locking Band. No locking band required with 2" version.

SIZE	ORDER #	STOCK #	A
2"   60mm	2PPS-VFTL	810009691	13 3/4"   349mm
3"   80mm	3PPS-VFTL	810009719	17"   432mm

### B-vent Retrofit Adapters

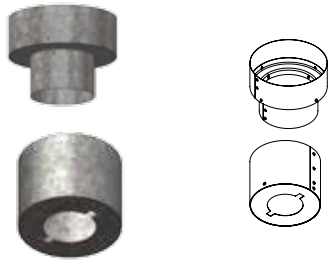

Use to retrofit common sizes of B-vent chimney for use as a chase for one appliance using PolyPro flex. Includes top cap adapter and bottom support cup. 3" size also includes required C-support plate.

SIZE	ORDER #	STOCK #
2"   60mm in a 3"   80mm chase	2PPS-BV3	810004332
2"   60mm in a 4"   100mm chase	2PPS-BV4	810004333
2"   60mm in a 5"   130mm chase	2PPS-BV5	810004334
3"   80mm in a 5"   130mm chase	3PPS-BV5	810004348
2"   60mm in a 6"   150mm chase	2PPS-BV6	810006999
3"   80mm in a 6"   150mm chase	3PPS-BV6	810005874

### Support Elbow



Use the support elbow to stabilize a vertical termination. Elbow has integrated support base that is compatible with bracket or support shown on the following page. Includes 1 Locking Band.

SIZE	ORDER #	STOCK #	SIZE	ORDER #	STOCK #
5"   130mm	5PPS-SE90L	810009765	8"   100mm	8PPS-SE90L	810009802
6"   60mm	6PPS-SE90L	810009786			

### Support Elbow Extended

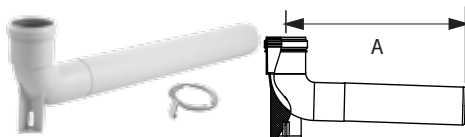

Use the extended support elbow to stabilize the vertical termination. Extended horizontal length can be trimmed to length as required. Elbow has integrated support base that is compatible with Support Bracket or Chimney Support shown. Includes 1 Locking Band.

SIZE	ORDER #	STOCK #	A
2"   60mm	2PPS-SE90XL	810009686	21 1/16"   551mm
3"   80mm	3PPS-SE90XL	810009715	22 1/4"   565mm
4"   100mm	4PPS-SE90XL	810009747	22 7/16"   570mm
5"   130mm	5PPS-SE90XL	810009766	24 7/16"   620mm

### Flex or Rigid Support Bracket



Use to secure the Support Elbow or the Extended Support Elbow inside a masonry chimney or chase. Heavy Duty.

SIZE	ORDER #	STOCK #
2"-8"   60mm - 200mm	PPS-SUP	810004225



### Flex Chimney Support

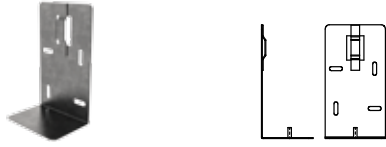

Use to support the Support Elbow inside a masonry chimney or chase. Includes mounting hardware and pipe support clamp.

SIZE	ORDER #	STOCK #	SIZE	ORDER #	STOCK #
2"   60mm	2PPS-SUP	810004338	4"   100mm	4PPS-SUP	810004364
3"   80mm	3PPS-SUP	810004352	5"   130mm	5PPS-SUP	810004375

### Flex Support Bracket

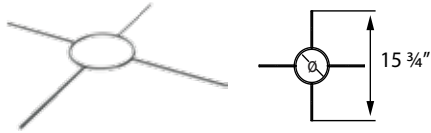

Use to support PolyPro Flex from top of masonry chimney or chase.

SIZE	ORDER #	STOCK #	SIZE	ORDER #	STOCK #
2"   60mm	2PPS-FSB	810004335	4"   100mm	4PPS-FSB	810004361
3"   80mm	3PPS-FSB	810004349	5"   130mm	5PPS-FSB	810004373

### Spacer



Use to center PolyPro flex. Universal for all diameters. Simple installation and ratchet adjustment. For 3" & 4" diameters, use 3PPS-S.

SIZE	ORDER #	STOCK #	SIZE	ORDER #	STOCK #
2"   60mm	2PPS-S	810004336	3"   80mm	3PPS-S	810004350
4"   100mm	4PPS-S	810004362			

### Flex Length



Use to line masonry chimneys that vent condensing appliances. Double-wall construction. Can be cut to precise length in the field. Available in 25, 35, or 50 foot lengths. 5" diameter flex comes in rolls of 98 feet only.

SIZE	25 FEET		35 FEET	
	ORDER #	STOCK #	ORDER #	STOCK #
2"   60mm	2PPS-FLEX25	810004318	2PPS-FLEX35	810004319
3"   80mm	3PPS-FLEX25	810004321	3PPS-FLEX35	810004322
4"   100mm	4PPS-FLEX25	810004324	4PPS-FLEX35	810004325
SIZE	50 FEET		82 FEET	
	ORDER #	STOCK #	ORDER #	STOCK #
2"   60mm	2PPS-FLEX50	810004320	-	-
3"   80mm	3PPS-FLEX50	810004323	-	-
4"   100mm	-	-	4PPS-FLEX	810004326
SIZE	98 FEET			
	ORDER #	STOCK #		
5"   130mm	5PPS-FLEX	810004327		

### Flex Adapter Kit



Use with PolyPro flex lining system. Includes one male and one female adapter. These allow you to switch from rigid pipe to flex at the base of the system and back to rigid at the top. Flex gaskets (2) included.

SIZE	ORDER #	STOCK #	SIZE	ORDER #	STOCK #
3"   80mm	3PPS-FAS	810009373	5"   130mm	5PPS-FAS	810007033
4"   100mm	4PPS-FAS	810005987			

### Flex Male Adapter



Use to connect PolyPro rigid pipe to PolyPro flex at the base of the system. Flex gasket included.

SIZE	ORDER #	STOCK #	SIZE	ORDER #	STOCK #
2"   60mm	2PPS-FAM	810004329	4"   100mm	4PPS-FAM	810004358
3"   80mm	3PPS-FAM	810004344	5"   130mm	5PPS-FAM	810004370

### Flex Female Adapter



Use to convert from PolyPro flex back to PolyPro rigid pipe towards the top of the vent system. Flex gasket included.

SIZE	ORDER #	STOCK #	SIZE	ORDER #	STOCK #
2"   60mm	2PPS-FAF	810004330	4"   100mm	4PPS-FAF	810004359
3"   80mm	3PPS-FAF	810004345	5"   130mm	5PPS-FAF	810004371

### Flex Coupler Adapter



Use to tightly connect one length of PolyPro flex to another. Two flex gaskets are included.

SIZE	ORDER #	STOCK #	SIZE	ORDER #	STOCK #
2"   60mm	2PPS-FAC	810004331	4"   100mm	4PPS-FAC	810004360
3"   80mm	3PPS-FAC	810004346	5"   130mm	5PPS-FAC	810004372

### Wall Plate

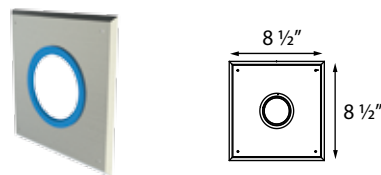

Use to trim wall penetration. Includes silicone seal for tight seal. Aluminum construction. White finish. Can be painted to suit.

SIZE	ORDER #	STOCK #	SIZE	ORDER #	STOCK #
2"   60mm	2PPS-WP	810004339	4"   100mm	4PPS-WP	810004365
3"   80mm	3PPS-WP	810004353	5"   130mm	5PPS-WP	810004376

### Viton Replacement Gasket Flex



Use as a replacement gasket for PolyPro flex products.

SIZE	ORDER #	STOCK #	SIZE	ORDER #	STOCK #
2"   60mm	2PPS-GAF	810004340	4"   100mm	4PPS-GAF	810004366
3"   80mm	3PPS-GAF	810004354	5"   130mm	5PPS-GAF	810004377

## Flex Puller



Use with the provided rope to guide PolyPro flex lengths down masonry chimney. 2" version snaps onto flex, 3" - 5" version twist-locks onto the male flex adapter.

SIZE	ORDER #	STOCK #	SIZE	ORDER #	STOCK #
2"   60mm	2PPS-FP	810004342	4"   100mm	4PPS-FP	810004368
3"   80mm	3PPS-FP	810004356	5"   130mm	5PPS-FP	810004378

## PolyPro Multi-Flex Venting System

## Reline Upper Plate



Use to seal pipe penetration with gasket, plate needs to be silicone sealed and fastened to (field fabricated) support plate.

SIZE	ORDER #	STOCK #	SIZE	ORDER #	STOCK #
2"   60mm	2PPS-RPU	810007982	4"   100mm	4PPS-RPU	810007963
3"   80mm	3PPS-RPU	810007983			

## Reline Hanger Support

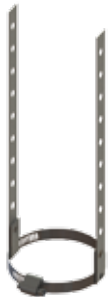

Use to support flex under the support plate. Clamps around the flex and is fastened to the support plate, then covered by the reline upper plate at the correct size. Universal for 2" - 4" diameters.

SIZE	ORDER #	STOCK #
2" - 4"   60mm - 100mm	PPS-RH	810007965