

AHCC SERIES- CASED HYDRONIC HEATING

Model: AHCC-2-150

The AHCC Series Cased Hydronic Heating Units are designed to provide exceptional hydronic heating when matched with any residential air handling system and a hot water source. The unit may be mounted upflow, counter flow or horizontally on the supply end of the air handler or within the duct system. The coils are designed and tested in accordance with the current AHRI Standard 410 and manufactured with UL listed components.

- High Performance Aluminum Fins
- Galvanized Casing with Access Panel
- Simple Installation in Multiple Configurations

Available through our large network of wholesale distributors.

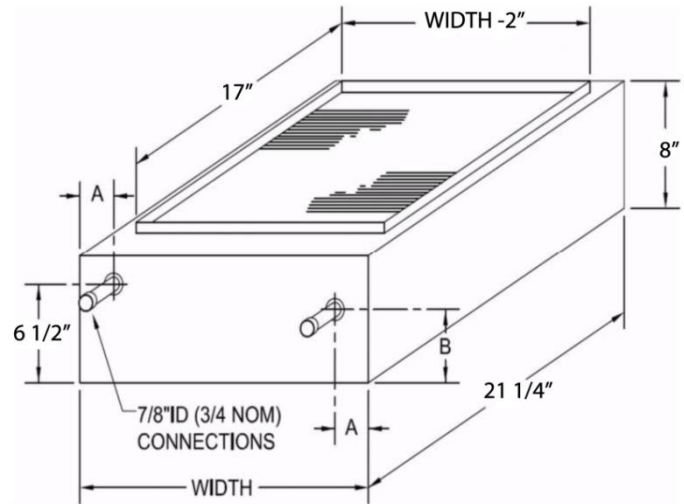

2 Row Unit			
Model	Width	A	B
AHCC-2-150	15"	2"	5-13/32"

Model Number: AHCC-2-150									
Total CFM	Ent. Dry Bulb °F	Lvg. Dry Bulb °F	Total Capacity MBH	Air Press. Drop "WG	Fluid Type	Total Flow Rate GPM	Ent. Fluid Temp. °F	Lvg. Fluid Temp °F	Fld Press. Drop 'WG
600	65.0	115.27	33.0	0.06	Water	4.1	160	143.58	4.13
700	65.0	112.65	36.5	0.09	Water	4.4	160	143.08	4.69
800	65.0	110.43	39.8	0.11	Water	4.7	160	142.74	5.29
900	65.0	108.52	42.9	0.15	Water	5.0	160	142.52	5.92
1000	65.0	106.69	45.7	0.18	Water	5.2	160	142.11	6.37
1100	65.0	105.22	48.5	0.22	Water	5.5	160	142.05	7.05
1200	65.0	103.77	51.0	0.26	Water	5.7	160	141.78	7.53
600	65.0	126.12	40.2	0.06	Water	4.1	180	159.94	4.04
700	65.0	122.95	44.4	0.09	Water	4.4	180	159.33	4.60
800	65.0	120.27	48.4	0.11	Water	4.7	180	158.91	5.18
900	65.0	117.95	52.2	0.15	Water	5.0	180	158.63	5.80
1000	65.0	115.73	55.6	0.18	Water	5.2	180	158.13	6.24
1100	65.0	113.95	59.0	0.22	Water	5.5	180	158.05	6.91
1200	65.0	112.19	62.0	0.26	Water	5.7	180	157.73	7.38