



CONDENSING GAS COMBI BOILER



Installation Manual

Models

CB199-DV / CB180-DV
Natural Gas(NG) / Liquid Propane Gas(LP)



Low NOx Approved
by SCAQMD
14ng/J or 20ppm
(Natural Gas Only)

Thank you for purchasing this Noritz Condensing Gas Combi Boiler.

Before using, please:

Read this guide completely for operation instructions.

Completely fill out the warranty registration card (included separately) and mail the detachable portion to Noritz America Corporation. Keep this guide (and the remainder of the warranty registration card) where it can be found whenever necessary.

Installation must conform with local codes, or in the absence of local codes, the National Fuel Gas Code, ANSI Z223.1/NFPA 54-latest edition and/or, Natural Gas and Propane Installation Code (CSA B149.1-latest edition). Where required by the authority having jurisdiction, the installation must conform to the Standard for Controls and Safety Devices for Automatically Fired Boilers, ANSI/ASME CSD-1. Noritz America reserves the right to discontinue, or change at any time, the designs and/or specifications of its products without notice.

WARNING

If the information in these instructions is not followed exactly, a fire or explosion may result, causing property damage, personal injury, or death.





- Do not store or use gasoline or other flammable vapors and liquids in the vicinity of this or any other appliance.
- **WHAT TO DO IF YOU SMELL GAS**
 - Do not try to light any appliance.
 - Do not touch any electrical switch; do not use any phone in your building.
 - Immediately call your gas supplier from a neighbor's phone. Follow the gas supplier's instructions.
 - If you cannot reach your gas supplier, call the fire department.
- Installation and service must be performed by a qualified installer, service agency or the gas supplier.

<u>Chapter 1</u>	Product Accessories	1-1 Included Accessories	3
		1-2 Optional Accessories	3
<u>Chapter 2</u>	Product Specifications	2-1 Specifications	4
		2-2 Dimensions & Connections	5
<u>Chapter 3</u>	Safety Requirements	3-1 Safety Precautions	6
		3-2 Before Installation	7
		3-3 Choosing Installation Site	8
		3-4 High Elevation Installations	9
		3-5 Installation Clearances	10
<u>Chapter 4</u>	Installation	4-1 Securing to the Wall	13
		4-2 Vent Pipe Installation	14
		4-3 Setting the High Elevation	21
		4-4 Gas Piping	22
		4-5 Water Piping	25
		4-6 Heating Installation	27
		4-7 Low Water Cutoff	28
		4-8 Pressure Relief Valve	29
		4-9 Condensate Piping	32
		4-10 Electrical Wiring	33
		4-11 Wiring Diagram For External Options	34
		4-12 Plumbing Guidelines	35
		4-13 Air Handler	38
		4-14 Trial Run-Auto Feeder Process	40
<u>Chapter 5</u>	Setting	5-1 Outdoor Temperature Reset	41
		5-2 Installer Mode (Parameter Settings)	47
<u>Chapter 6</u>	Final Check Points & Maintenance	6-1 Final Check List	53
		6-2 Maintenance	54
	Memo		56

Chapter 1. – Product Accessories

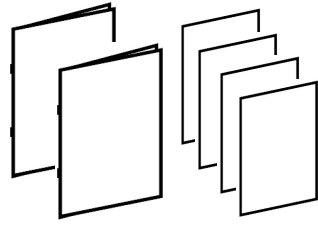
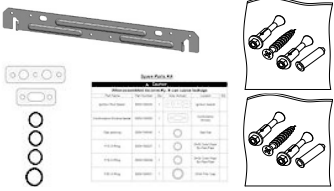



1-1. Included Accessories

The following accessories are included with the unit. Check for any missing items before starting installation.

Part	Shape	Q'ty	Part	Shape	Q'ty
Combi Boiler		1	Owner's Guide, Warranty Card, Installation Manual, Quick Installation Guide, Technical Data Sheet, Part List		1 each
Anchors / Wall Mounting Bracket / Emergency Kit		1 each	Bird Screen with Finishing (3")		2
Outdoor Temperature Sensor		1	Pressure Relief Valve for Heating (ASME Certified) (3/4", 30 psi)		1

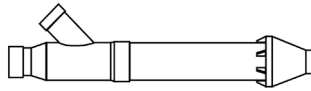
1-2. Optional Accessories

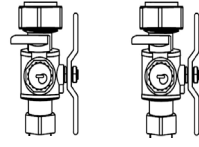
The accessories listed below are not included with the unit, but may be necessary for installation.

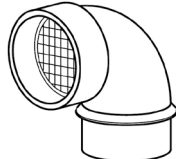
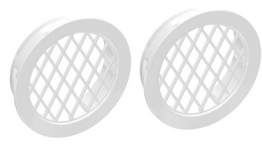
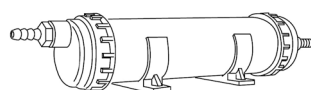
Part	Shape	Q'ty	Part	Shape	Q'ty
PVC Terminal VK3-H-PVC		1	Horizontal Hood Termination PVT-HL		1 each
VK3-PVC-VAS		1	Isolation Valve Set for DHW (IK-WV-200-1-XX)		1
PVC Terminal PRC-1		1	Pressure Relief Valve for DHW (3/4", 150 psi)		1
SV Conversion Kit (#SV-CK-3) •90 Elbow (With Inlet Screen)		1	Bird Screens with Finishing (2") (After market)		2
Neutralizer (NC-1) (For 1 Combi Boiler)		1			

2-1. Specifications Specifications may be changed without prior notice. The capacity may differ slightly, depending on the water pressure, water supply, piping conditions, and water temperature.

Model Name		CB199-DV		CB180-DV		
Gas Input Rate (DHW mode)	MAX	199,000 Btu/h		180,000 Btu/h		
	MIN	18,000 Btu/h		18,000 Btu/h		
DHW Capacity	35°F Rise	9.2 GPM		9.2 GPM		
	45°F Rise	7.7 GPM		7.2 GPM		
	77°F Rise	4.5 GPM		4.2 GPM		
Gas Input Rate (Heating mode)	MAX	120,000 Btu/h		100,000 Btu/h		
	MIN	18,000 Btu/h		18,000 Btu/h		
Installation		Indoor Wall Hung				
Flue System		Sealed Combustion Direct Vent, Single Vent				
Max Vent Run		2"(50ft) / 3"(100ft) Schedule 40 PVC, CPVC, PP				
Orifice Size	NG (Gas / Needle)	0.342"(8.7mm) / 0.354"(9.0mm)				
	LP (Gas / Needle)	0.271"(6.9mm) / 0.279"(7.1mm)				
Gas Supply Pressure	NG	3.5" WC to 10.5" WC				
	LP	8.0" WC to 14.0" WC				
Manifold Pressure	Gas Type		NG	LP	NG	LP
	Low Fire	2" / 3" VENT	-0.10 ± 0.01WC	-0.06 ± 0.01WC	-0.10 ± 0.01WC	-0.06 ± 0.01WC
	High Fire	DHW	2" / 3" VENT	-0.36 ± 0.01 WC	-0.30 ± 0.01WC	-0.31 ± 0.01 WC
Heating		2" / 3" VENT	-0.20 ± 0.01 WC	-0.15 ± 0.01 WC	-0.18 ± 0.01 WC	-0.13 ± 0.01 WC
Power Supply	Main Supply		120VAC 60Hz			
	Maximum Power Consumption		187W(71W+116W Pump)		180W (64W + 116W Pump)	
		120VAC Max 2A External Pump (Optional)				
Ignition System		Direct Electronic Ignition / Automatic Flame Sensing				
Burner System		Premixed Metal Fiber Burner				
Gas Valve System		Air Ratio Valve				
Minimum Flow Activation Flow		0.5 GPM				
Internal Pipe Material		STS 304, Copper Tubing				
Dimensions		W17.3" – H28.7" – D14.8"				
Weight		90lb				
Water Holding Capacity		Under 2 Gallon				
Control Panel /Circuit Board		P-960C / NGTX-9600C				
Water Pressure	MAX	DHW150 psi / Heating 30 psi				
	MIN	DHW 15 psi / Heating 12 psi				
Materials	Case	Cold Rolled Carbon Steel				
	Heat Exchanger	Heat Exchanger : STS 304				
Safety Devices		Flame Sensor, High Limit Switch , Gas Leakage Detector , Water Leakage Detector Exhaust Thermistor, Pressure Sensor Heating Supply Thermistor				

2-2. Dimensions & Connections

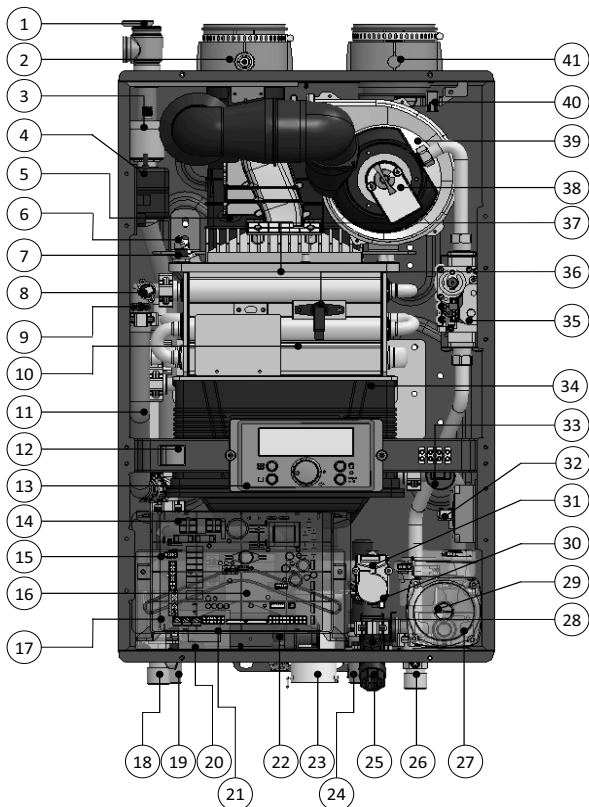
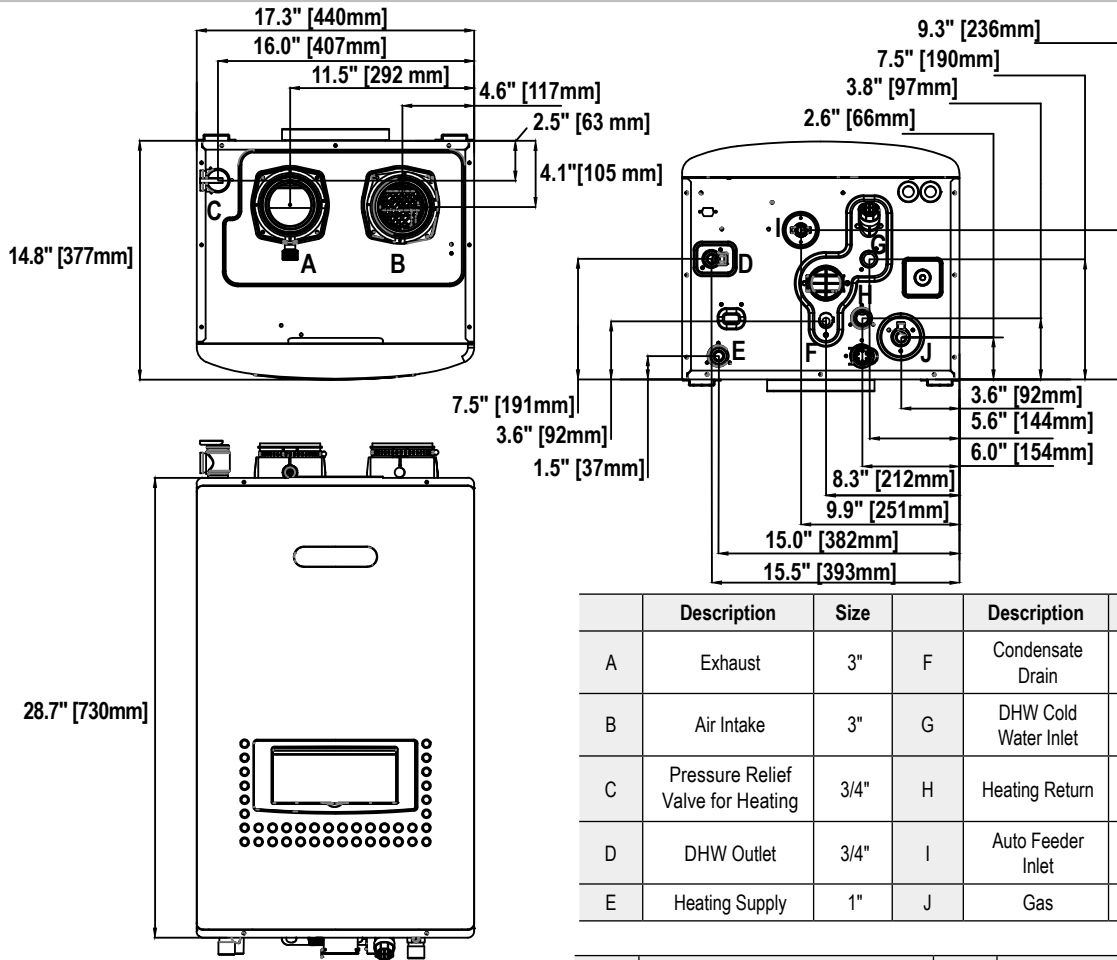

NO	Name of Component	NO	Name of Component
1	Pressure Relief Valve	22	Auto Feeder
2	Exhaust	23	Condensate Trap
3	Air Vent	24	Heating Return Connection (Filter)
4	Igniter	25	DHW Cold Water Connection
5	Exhaust Thermistor	26	Gas Connection
6	Ignition Rod	27	Circulation Pump
7	Burner Limit Switch	28	DHW Cold Water Thermistor
8	High Limit Switch	29	Heating Return Thermistor
9	Heating Supply Thermistor	30	Water Flow Sensor
10	Primary Heat Exchanger	31	Flow Control Valve
11	Heating Outlet Pipe	32	Air Pressure Switch
12	Manual Power Switch	33	Pressure Sensor
13	Control Panel	34	Secondary Heat Exchanger
14	Circuit Board	35	Gas Valve
15	3-Way Valve	36	Flame Sensor
16	DHW Plate Heat Exchanger	37	Burner
17	DHW Thermistor	38	AGM (Air Gas Mixer)
18	DHW Connection	39	Fan Motor
19	Heating Supply Connection	40	Air Inlet Filter
20	Water Leakage Detector	41	Air Intake
21	AC 24V Transformer		

3-1. Safety Precautions

WARNING

To avoid product damage, personal injury, or even possible death, carefully read, understand, and follow all the instructions in the Installation Manual and Owner's Guide before installation, operation and service of the Combi Boiler.

Noritz cannot anticipate every circumstance that might involve a potential hazard. Therefore, all possible incidents are not included in our warnings. Proper installation, operation, and service are your responsibility.

You must make sure that the operation and settings of the Combi Boiler are safe for you and for others.

This manual provides Safety Symbols. When the user fails to adhere to the following requirement, it will cause death, serious damages, and a great property loss.

For safety symbols, 'DANGER', 'WARNING', 'CAUTION' are indicated and the definitions for these terms are as follow:

DANGER

Indicates an imminently hazardous situation which, if not avoided, will result in death or serious injury. This signal word is limited to the most extreme situations.

WARNING

Indicates a potentially hazardous situation which, if not avoided, could result in death or serious injury.

CAUTION

Indicates a potentially hazardous situation which, if not avoided, may result in minor or moderate injury. It is also used to alert against unsafe practices and hazards involving only property damage.

3-2. Before Installation

DANGER

Check the fixing brackets and vent pipe yearly for damage or wear. Replace if necessary.

WARNING

Precautions on Vent Pipe Replacement

The vent system will almost certainly need to be replaced when this appliance is being installed. Only use vent materials that are specified in this Installation Manual for use on this appliance. Refer to the “Vent Pipe Installation” section for details. If PVC, CPVC, or Category IV listed pipe is already installed, check for punctures, cracks, or blockages and consult with the vent pipe manufacturer before reusing.

Improper venting may result in fires, property damage or exposure to Carbon Monoxide.

Snow Precaution

If this product will be installed in an area where snow is known to accumulate, protect the vent termination from blockage by snow drifts or damage from snow falling off of roofs.

Check the Gas

Check that the rating plate indicates the correct type of gas.

Check that the gas supply line is sized for 199,000 Btu/h/ 120,000Btu/h (DHW / Heating mode) of CB199-DV model.

Check that the gas supply line is sized for 180,000 Btu/h/ 100,000Btu/h (DHW / Heating mode) of CB180-DV model.

Check the Power

The power supply required is 120VAC, at 60Hz.

Using the incorrect voltage may result in fire or electric shock.

CAUTION

Do Not Use Equipment for Purposes Other Than Those Specified.

Do not use for other than increasing the temperature of the water supply, as unexpected accidents may occur as a result.

Check Water Supply Quality

If the water supply is in excess of 12 grains per gallon (200 mg/L) of hardness, acidic or otherwise impure, treat the water with approved methods in order to ensure full warranty coverage.

3-3. Choosing Installation Site

Locate the appliance in an area where leakage from the unit or connections will not result in damage to the area adjacent to the appliance or to the lower floors of the structure. When such locations cannot be avoided, it is required that a suitable drain pan, adequately drained, be installed under the appliance.

The pan must not restrict combustion air flow.

⚠ DANGER

Locate the vent terminal so that there are no obstacles around the termination and so that exhaust can't accumulate. Do not enclose the termination with corrugated metal or other materials.

⚠ WARNING

Avoid places where fires are common, such as those where gasoline, benzene and adhesives are handled, or places in which corrosive gases (ammonia, chlorine, sulfur, ethylene compounds, acids) are present. Using the incorrect voltage may result in fire or cracking.

Avoid installation in places where dust or debris will accumulate. Dust may block the air-supply opening, causing the performance of the device fan to drop and incomplete combustion to occur as a result.

Avoid installation in places where special chemical agents (e.g., hair spray or spray detergent) are used. Ignition failures and malfunction may occur as a result.

Carbon Monoxide Poisoning Hazard. Do not install this Combi Boiler in a mobile home, recreational vehicle or on a boat.

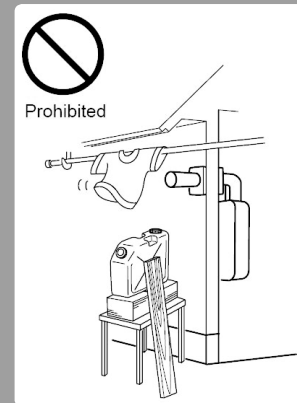

⚠ CAUTION

The Combi Boiler is designed for indoor installation only. Never install it outdoors or in a bathroom, it may be damaged or a fire may be caused.

Consult with the customer concerning the location of installation.

Install the Combi Boiler in an area that allows for the proper clearances to combustible and noncombustible construction. Consult the rating plate on the appliance for proper clearances.

Do not install the Combi Boiler in a place where it may be threatened by falling objects, such as under shelves.

The Combi Boiler must be installed in a place where supply and exhaust pipes can be installed as directed.

Do not install the Combi Boiler where the exhaust will blow on outer walls or material not resistant to heat. Also consider the surrounding trees and animals.

The heat and moisture from the Combi Boiler may cause discoloration of walls and resinous materials, or corrosion of aluminum materials.

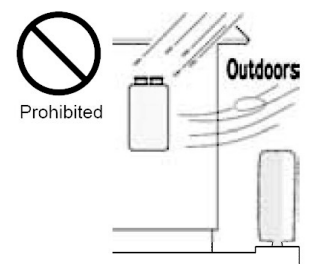

⚠ CAUTION

Avoid installation above gas ranges or stoves.

Avoid installation between the kitchen fan and stove. If oily fumes or a large amount of steam are present in the installation location, take measures to prevent the fumes and steam from entering the equipment.

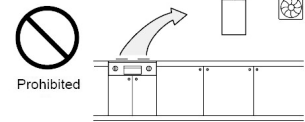

Install the unit in a location where the exhaust gas flow will not be affected by fans or range hoods.

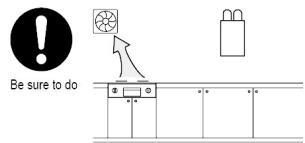

Take care that noise and exhaust gas will not affect neighbors. Avoid installation on common walls as the unit will make some operational noises while it is running.



Before installing, make sure that the exhaust flue termination meets clearance requirements proper clearances according to the National Fuel Gas Code (ANSI Z223.1).

State of California:

The Combi Boiler must be braced, anchored or strapped to avoid moving during an earthquake. Contact local utilities for code requirements in your area or call: 1-866-766-7489 and request instructions.

3-4. High Elevation Installations

- This unit is only ANSI/CSA certified for installation up to 4,500 ft. (1,350 m) above sea level.
- For installations at higher elevations, please refer to the directions below or contact Noritz America.

Note:

This Combi Boiler may be installed at elevation up to 10,000 ft for use with Natural Gas and Propane. The Combi Boiler must be set for a specific altitude using the Installer Mode Setting described below. Above 2,000 ft (610 m), the Combi Boiler will de-rate by 4% for each 1,000 ft (305 m) of altitude gain.

[Installer Mode]

Display	Operation	Description
7:EL	High Elevation	Select an altitude range from the following four options based on where the Combi Boiler is installed.
0 ~ 2	Default	0 ~ 1,999 ft (0 ~ 609 m)
2 ~ 5		2,000 ~ 4,999 ft (610 ~ 1,523 m)
5 ~ 8		5,000 ~ 7,999 ft (1,524 ~ 2,438 m)
8 ~ 10		8,000 ~ 10,000 ft (2,439 ~ 3,048 m)

* Please refer to page 21 for more detail setting method on control panel.

3-5. Installation Clearances

⚠ WARNING

Before installing, check for the following:

Install in accordance with relevant building and mechanical codes, as well as any local, state or national regulations, or in the absence of local and state codes, to the National Fuel Gas Code ANSI Z223.1/NFPA 54 – latest edition. In Canada, see Natural Gas and Propane Installation Code (CSA B149.1-latest edition). for detailed requirements.

Distance from combustibles

Maintain the following clearances from both combustible and non-combustible materials.

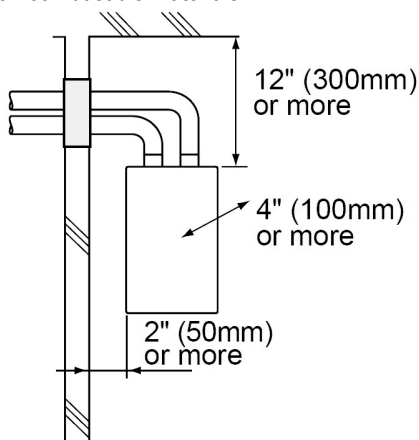

Securing of space for repair/inspection

If possible, leave 8" (200mm) or more on either side of the unit to facilitate inspection.

If possible, leave 24" (600mm) or more in front of the unit to facilitate maintenance and service if necessary.

If possible, leave 3" (75mm) or more above and below the vent pipe to facilitate inspection and repair if necessary

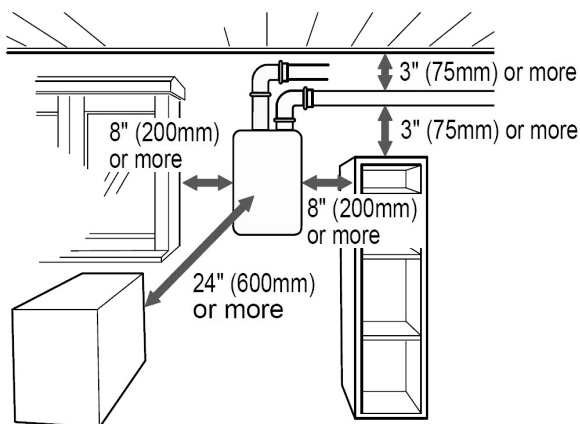

Cooking Equipment

<When the indoor air supply>

- If the unit will be installed in the vicinity of a permanent kitchen range or stove that has the possibility of generating steam that contains fats or oils, use a dividing plate or other measure to ensure that the unit is not exposed to air containing such impurities.

* The dividing plate should be of noncombustible material of a width greater than the Combi Boiler.

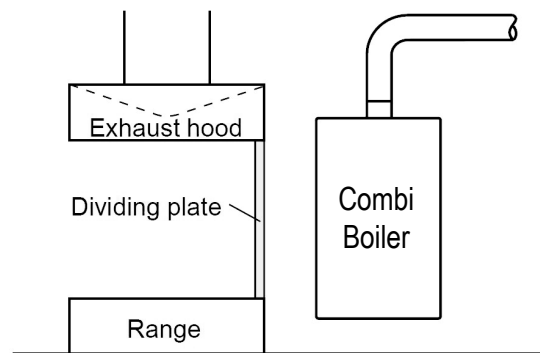

**Clearance Requirements from Vent Terminations to Building Openings
<When supplying combustion air from the outdoors (Direct Vent)>**

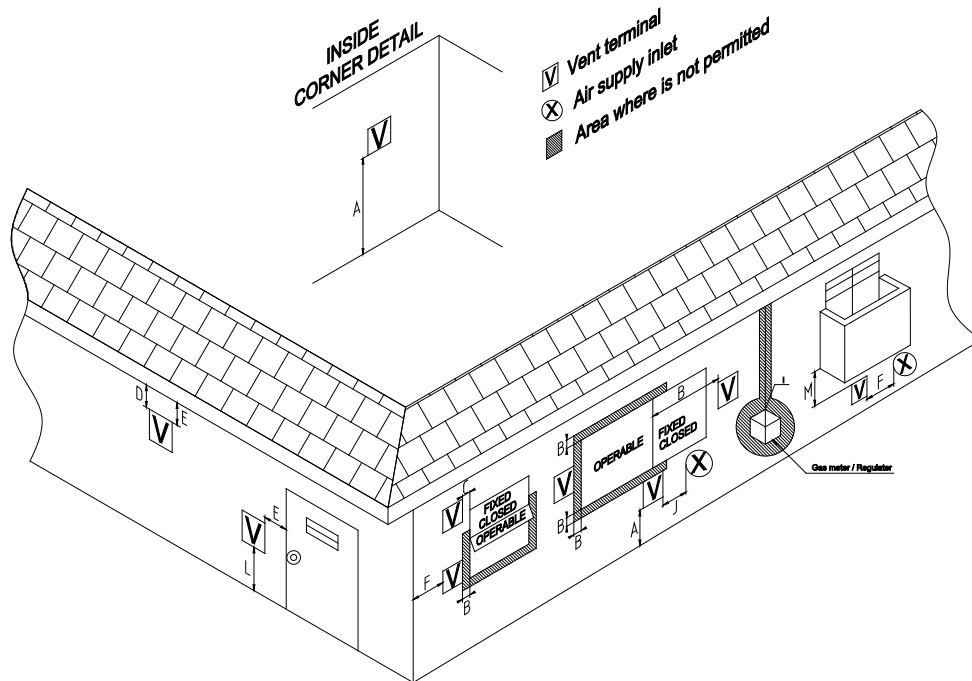

	Description	US Direct Vent Installations ¹	Canadian Direct Vent Installations ²
A	Clearance above grade, veranda, porch, deck, or balcony	12 in (30 cm)	12 in (30 cm)
B	Clearance to window or door that may be opened	12 in (30 cm)	36 in (91 cm)
C	Clearance to permanently closed window	*	*
D	Vertical clearance to ventilated soffit located above the terminal within a horizontal distance of 2 feet from the center line of the terminal	*	*
E	Clearance to unventilated soffit	*	*
F	Clearance to outside corner	*	*
G	Clearance to inside corner	*	*
H	Clearance to each side of center line extended above meter/regulator assembly	*	3 ft (91 cm) within a height 15 ft above the meter/regulator assembly
I	Clearance to service regulator vent outlet	*	3 ft (91 cm)
J	Clearance to non-mechanical air supply inlet to building or the combustion air inlet to any other appliance	12 in (30 cm)	36 in (91 cm)
K	Clearance to a mechanical air supply inlet	3 ft (91 cm) above if within 10 ft (3 m) horizontally	6 ft (1.83 m)
L	Clearance above paved sidewalk or paved driveway located on public property	*	7 ft (2.13 m) †
M	Clearance under veranda, porch, deck, or balcony	*	12 in (30 cm) ‡

¹ In accordance with the current ANSI Z223.1 / NFPA 54 National Fuel Gas Code.

² In accordance with the current CSA B149.1 Natural Gas and Propane Installation Code.

† A vent shall not terminate directly above a sidewalk or paved driveway that is located between two single family dwellings and serves both dwellings.

‡ Permitted only if veranda, porch, deck, or balcony is fully open on a minimum of two sides beneath the floor.

* Clearance in accordance with local installation codes and the requirements of the gas supplier. Clearance to opposite wall is 24 inches (60 cm).

**Clearance Requirements from Vent Terminations to Building Openings
<When supplying combustion air from the indoors (Non-Direct Vent)>**

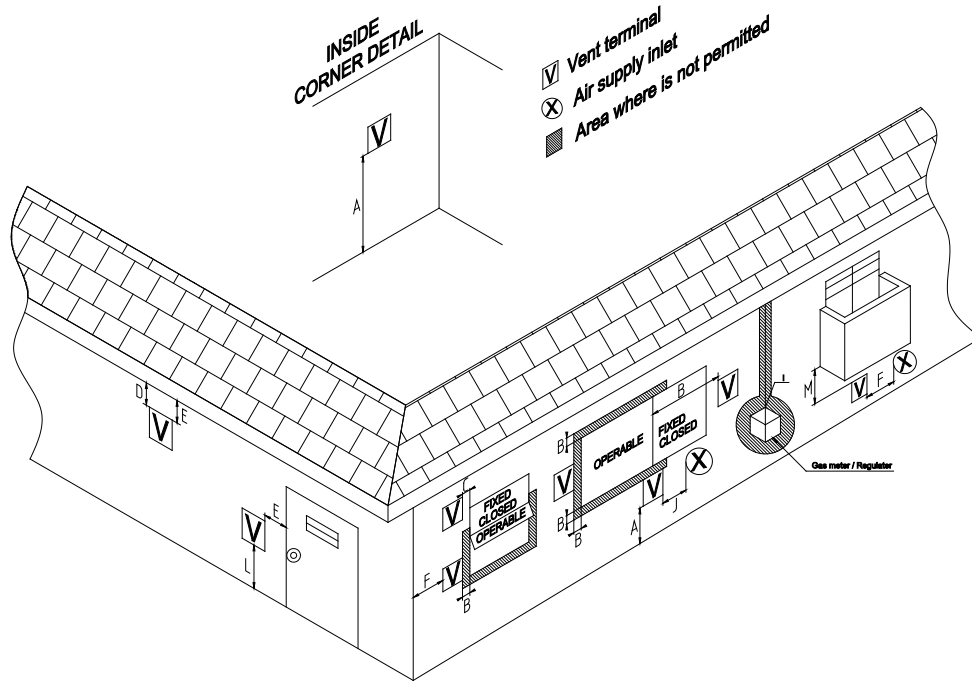

	Description	US Non-Direct ¹	Canadian Non-Direct ²
A	Clearance above grade, veranda, porch, deck, or balcony	12 in (30 cm)	12 in (30 cm)
B	Clearance to window or door that may be opened	48 in (120 cm) below or to side of opening; 12 in (30 cm) above opening	36 in (91 cm)
C	Clearance to permanently closed window	*	*
D	Vertical clearance to ventilated soffit located above the terminal within a horizontal distance of 2 feet from the center line of the terminal	*	*
E	Clearance to unventilated soffit	*	*
F	Clearance to outside corner	*	*
G	Clearance to inside corner	*	*
H	Clearance to each side of center line extended above meter/regulator assembly	*	36 in (91 cm) within a height 15 ft (4.57 m) above the meter/ regulator assembly
I	Clearance to service regulator vent outlet	*	36 in (91 cm)
J	Clearance to non-mechanical air supply inlet to building or the combustion air inlet to any other appliance	48 in (120 cm) below or to side of opening; 12 in (30 cm) above opening	36 in (91 cm)
K	Clearance to a mechanical air supply inlet	36 in (91 cm) above if within 10 ft (3 m) horizontally	6 ft (1.83 m)
L	Clearance above paved sidewalk or paved driveway located on public property	*	7 ft (2.13 m) †
M	Clearance under veranda, porch, deck, or balcony	*	12 in (30 cm) ‡

¹ In accordance with the current ANSI Z223.1 / NFPA 54 National Fuel Gas Code.

² In accordance with the current CSA B149.1 Natural Gas and Propane Installation Code.

† A vent shall not terminate directly above a sidewalk or paved driveway that is located between two single family dwellings and serves both dwellings.

‡ Permitted only if veranda, porch, deck, or balcony is fully open on a minimum of two sides beneath the floor.

* Clearance in accordance with local installation codes and the requirements of the gas supplier. Clearance to opposite wall is 24 inches (60 cm).

4-1. Securing to the wall

⚠ WARNING

CLEARANCES FOR SERVICE ACCESS

The Combi Boiler must be installed on a wall that can bear its weight.
 If you try to install the Combi Boiler on a wall which cannot support its weight, please reconsider.
 The Combi Boiler can be installed on any suitable internal wall (suitable sound proofing may be required when installing onto a stud partition wall).

1. Use the wall bracket to mark two locations where the anchor bolts will be inserted. (Make sure that the wall bracket is level)
2. Drill two holes with a 15/32" (12mm) size bit and insert the two anchor bolts into the holes with the threaded end out.
3. Place the wall bracket on the two anchor bolts.
4. Place washers and nuts on each anchor bolt and tighten. Make sure that it is leveled and it can support the weight of the Combi Boiler.

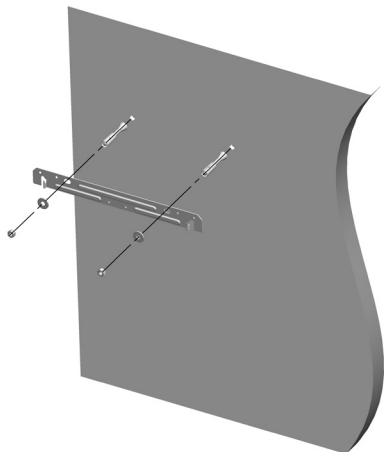

5. Lift up the Combi Boiler, rest the unit on the hooks provided on the wall bracket that is already mounted on the wall.

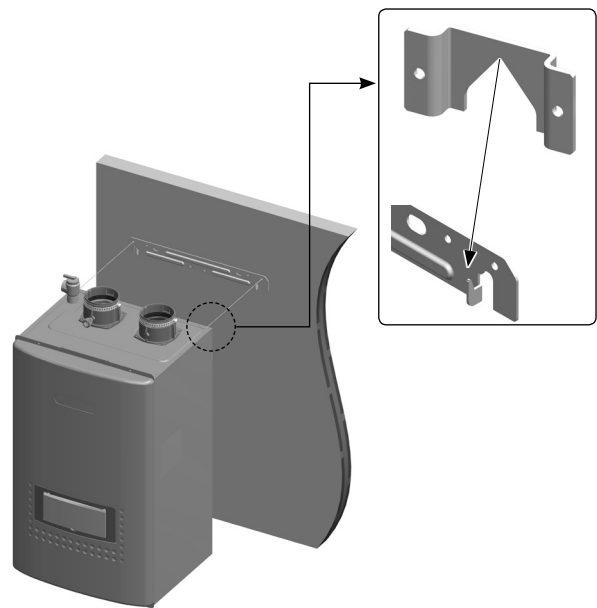

6. Locate the lower mounting bracket on the bottom of the Combi Boiler. The two screws and dry wall anchors will be used to secure the bottom of the unit to the wall.

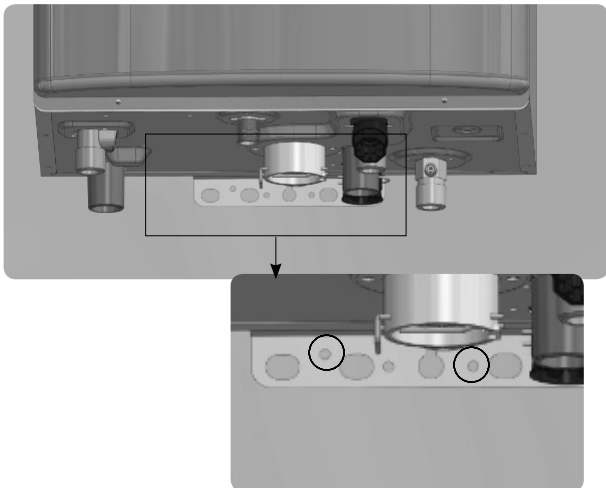

7. Mark two holes. Then remove the Combi Boiler from the wall.
8. Drill two holes with a 17/64" (7mm) size bit. Then insert the two dry wall anchors into the wall.

9. Place the Combi Boiler back on the wall. (same as step 5)
10. Screw in the two screws into the dry wall anchors.

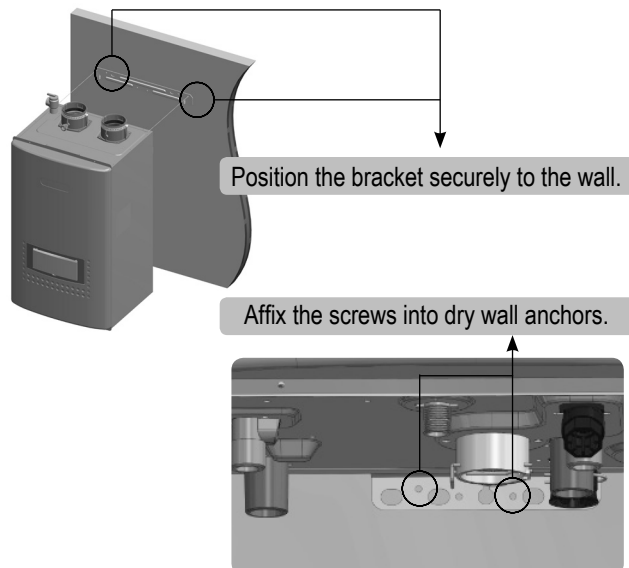

4-2. Vent Pipe Installation (Indoor Installation Only)

■ General Requirements

- Under normal conditions, this appliance will not produce an exhaust flue temperature in excess of 149°F (65°C) and schedule 40 PVC pipe may be used as the vent material. If the Combi Boiler set temperature is 160°F (70°C) or higher, schedule 40 CPVC or PP must be used.
- When using CPVC or PP, a setting must be changed in the Installer Mode [6:Vt]. This setting will allow the burner cutoff temperature to be increased from 149°F(65°C) to 200°F(93°C).See the next page for details.
- Make sure the vent system is gas tight and will not leak.
- Support the vent pipe with hangers at regular intervals as specified by these instructions or the instructions of the vent manufacturer.
- Do not common vent or connect more than one appliance to this venting system.
- The total vent length including horizontal & vertical vent runs should be no less than 3' (0.9m).
- Do not store hazardous or flammable substances near the vent termination and check that the termination is not blocked in any way.

■ Venting With PVC or CPVC, Polypropylene(PP)

This appliance can be vented with non cellular core plastic pipe materials as specified in the below table. Vent installations in Canada which utilize plastic vent systems must comply with ULC S636.

Item	Material	United States	Canada
Exhaust /Air Intake	Schedule 40 PVC	ANSI/ASTM D1785	ULC S636 Certified Materials Only
	PVC-DWV	ANSI/ASTM D2665	
	Schedule 40 CPVC	ANSI/ASTM F441	
	Polypropylene(PP)	ANSI/ASTM 7254	
Pipe Cement/Primer	PVC	ANSI/ASTM D2564	
	CPVC	ANSI/ASTM F493	
Note: Do Not Use Cellular Foam Core Pipe			

- Use only solid PVC or CPVC schedule 40 or PP pipe. Cellular foam core piping is not allowed.
- In Canada, plastic vent systems must be certified to ULC S636. The components of the certified vent system must not be interchanged with other vent systems or unlisted pipe/fittings.
- In Canada, specified primers and glues of the ULC S636 certified vent system must be from a single system manufacturer and not intermixed with other system manufacturer’s vent system parts.
- PVC, CPVC or PP pipe has been approved for use on this appliance with zero clearance to combustibles.
- Follow all general venting guidelines as outlined on this page.
- The pipe shall be installed so that the first 3' (0.9m) of pipe from the appliance flue outlet is readily accessible for visual inspection.
- When preparing and assembling the pipe, follow instructions as provided by the pipe manufacturer. In general, the following practices must be observed:
 - * Squarely cut all pieces of pipe.
 - * Remove all burrs and debris from joints and fittings.
 - * All joints must be properly cleaned, primed, and cemented. Use only cement and primer approved for use with the pipe material as outlined in the above table.
- All piping must be fully supported. Use pipe hangers at a minimum of 3' (0.9m) intervals. Do not use the Combi Boiler to support the vent piping.
- A bird screen must be installed on the vent terminations to prevent debris or animals from entering the piping.

Vent Material Setting

⚠ CAUTION

- This Combi Boiler has a built-in control to limit the exhaust temperature to 149°F (65°C). As a result, the Combi Boiler can be vented with Schedule 40 PVC.
- In high temperature applications, the exhaust temperature can exceed 149°F (65°C). In that case, you must use Schedule 40 CPVC or Approved Polypropylene (PP) in the USA or Type BH Special Gas Vent Class IIB (CPVC) or Class IC(Polypropylene) that conforms to ULC-S636 in Canada.

■ PVC Venting

- This Combi Boiler is set to "PVC" (factory default). The Combi Boiler will control and maintain the exhaust temperature below 144°F (62°C) and the Combi Boiler will shut down when the exhaust temperature exceeds 149°F (65°C).

■ CPVC or Polypropylene(PP) Venting

- When you design a high temperature application (the exhaust temperature can exceed 149°F (65°C)), you must use Schedule 40 CPVC or Approved Polypropylene (PP) in the USA or Type BH Special Gas Vent Class IIB (CPVC) or Class IC(Polypropylene) that conforms to ULC-S636 in Canada and must change the Vent Material Setting as follows.
- In this case, the Combi Boiler will control and maintain the exhaust temperature below 195°F (90.5°C) and the Combi Boiler will shut down when the exhaust temperature exceeds 200°F (93°C) .

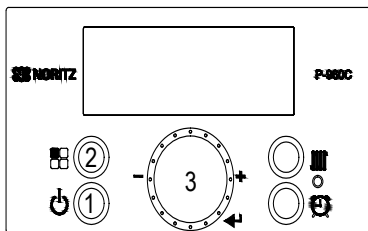

1. Turn off the control panel.
2. Press and hold the 'Function Button' for approximately 5 seconds to get into the 'Installer Mode'.
3. Turn the 'Dial Button' clockwise until '6: Vt' displays.

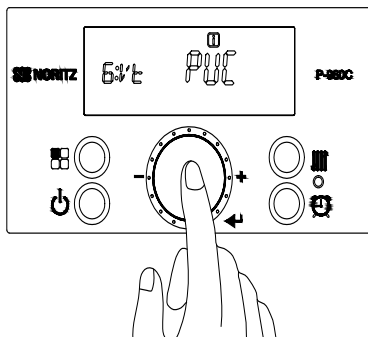

4. Press the 'Dial Button' ('PVC' will be blinking), then turn the 'Dial Button' clockwise so 'CPVC' is blinking.

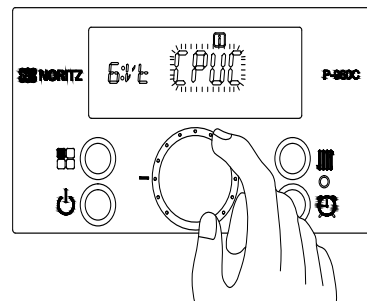

5. Press the 'Dial Button' in order to save the setting.
6. Press the 'Function Button', to return to normal mode.

Maximum Vent Length

The unit can be adjusted to accommodate longer vent runs; refer to the below table to find the maximum vent length based on the number of elbows.

Allowable Schedule 40 Vent Length (PVC, CPVC, PP)

Pipe diameter	3" (75mm)	2" (50mm)
No. of Elbows	Max. straight Vent Length*	
6	70'	N/A
5	75'	N/A
4	80'	18'
3	85'	26'
2	90'	34'
1	95'	42'
0	100'	50'

- 5 feet (1.5M) for each additional 3-inch 90-degree elbow
- 2.5 feet (0.75M) for each additional 3-inch 45-degree elbow
- 8 feet (2.4M) for each additional 2-inch 90-degree elbow
- 4 feet (1.2M) for each additional 2-inch 45-degree elbow

* The termination elbow must be included in the total number of elbows.

Vent Termination

Bird Screen Installation

- Install vent screen (Only 3" bird screens are included as accessories), see the below figure for appropriate configuration.
- After connecting vent/air inlet terminal, it is required to install a bird screen into the termination to prevent incoming of debris and animals, which might cause damage to the unit.
(2" bird screen (1/4" mesh) must be purchased for 2" venting installation)

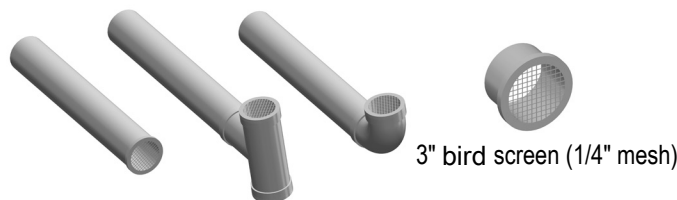

Tightening

- You can select the size of vent pipe(2" or 3") according to the installation conditions.
- Push the pipe into the unit flue until it touches the bottom.
- Tighten the band clamps using a screwdriver.
- Finally, make sure that both pipes(exhaust & air intake) are securely fixed.

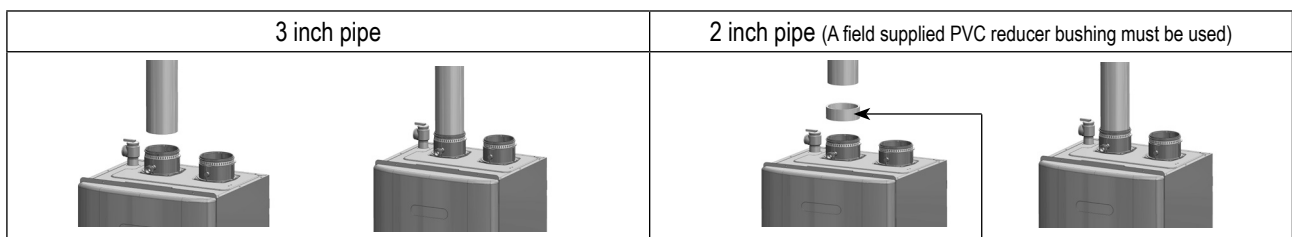

Reducer bushing

Vent Pipe Installation (DV-Direct Vent)

■ Horizontal Vent Termination- PVC/CPVC/PP Materials Only

- As illustrated on the right, make sure to keep a distance of 3' (0.9m) or wider between the intake and exhaust when installing the vent piping.
- * If 3' (0.9m) remote distance between Intake and Exhaust cannot be ensured, the installation can be carried out only in the installation method shown in page 19.
- The PVT-HL termination may be used in place of elbows as the horizontal vent terminations. It is not necessary to use bird screens with the PVT-HL termination.
- Terminate at least 12" (300mm) above grade or above snow line.
- Terminate at least 7' (2.1m) above a public walkway, 6' (1.8m) from the combustion air intake of any appliance, and 3' (0.9m) from any other building opening, gas utility meter, service regulator etc.
- Terminate at least 3' (0.9m) above any forced air inlet within 10' (3m) , 1' (0.3m) below, 1' (0.3m) horizontally from or 1' (0.3m) above any door, window, or gravity air inlet into any building per National Fuel Gas Code ANSI Z223.1/NFPA 54.
- Slope the horizontal vent 1/4" upwards for every 12" (300mm) toward the termination.
- Use a condensation drain if necessary.
- In the Commonwealth of Massachusetts a carbon monoxide detector is required for all side wall horizontally vented gas fuel equipment. Please refer to Technical Bulletin TB 010606 for full installation instructions.

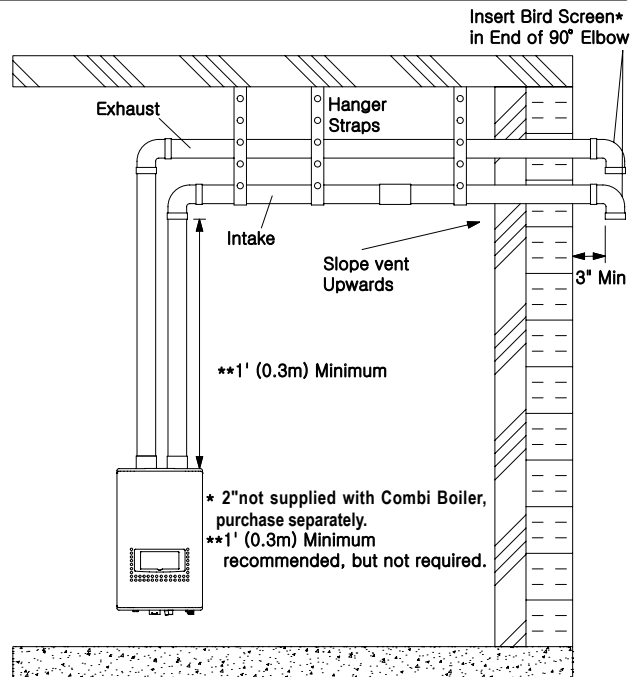

When choosing intake and exhaust terminations, you must use the same type of elbow (i.e. both 90° elbows). This will help with proper combustion by putting both terminations in the same pressure zone.

■ Vertical Vent Termination- PVC/CPVC/PP Materials Only

- As illustrated on the right, make sure to keep a distance of 3' (0.9m) or wider between the intake and exhaust when installing the vent piping.
- Terminate at least 6' (1.8m) from the combustion air intake of any appliance, and 3' (0.9m) from any other building opening, gas utility meter, service regulator etc.
- Enclose exterior vent systems below the roof line to limit condensation and protect against mechanical failure.
- When the vent penetrates a floor or ceiling and is not running in a fire rated shaft, a firestop and support is required.
- When the vent termination is located not less than 8' (2.4m) from a vertical wall or similar obstruction, terminate above the roof at least 2' (0.6m), but not more than 6' (1.87m), in accordance with the National Fuel Gas Code ANSI Z223.1/NFPA 54.
- Provide vertical support every 3' (0.9m) or as required by the vent pipe manufacturer's instructions.
- A short horizontal section is recommended to prevent debris from falling into the Combi Boiler.
- When using a horizontal section, slope the horizontal vent 1/4" upwards for every 12" (300mm) toward the termination to drain condensate.

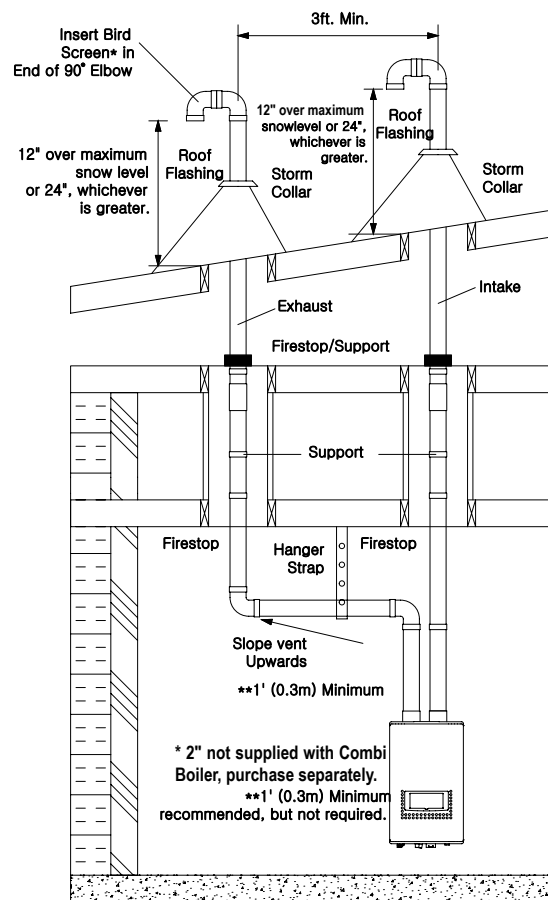

When choosing intake and exhaust terminations, you must use the same type of elbow (i.e. both 90° elbows). This will help with proper combustion by putting both terminations in the same pressure zone.

Vent Pipe Installation (DV-Direct Vent)

■ Concentric PVC/CPVC Termination

- PP can not be used if the concentric termination is being used. Must use PVC or CPVC.
- The concentric termination may be shortened, but not lengthened from its original factory supplied length.
- 2" (50mm) & 3" (75mm) PVC or CPVC pipe may be used with the concentric termination. Reducers will be needed to connect 2" pipe. Maintain the same vent pipe diameter from the Combi Boiler flue to the termination.
- Do not exceed the maximum vent lengths as specified in this section.
- There must be a 1" (25mm) to 4" (100mm) clearance between the outside wall and the air intake section of the termination as illustrated on the left.
- Install a securing strap to prevent movement of the termination.
- Terminate at least 12" (300mm) above grade or above snow line.
- Terminate at least 7' (2.1m) above a public walkway, 6' (1.8m) from the combustion air intake of any appliance, and 3' (0.9m) from any other building opening, gas utility meter, service regulator etc.
- Terminate at least 3' (0.9m) above any forced air inlet within 10' (3m), 1' (0.3m) below, 1' (0.3m) horizontally from or 1' (0.3m) above any door, window, or gravity air inlet into any building per National Fuel Gas Code ANSI Z223.1/NFPA 54.
- Slope the horizontal vent 1/4" upwards for every 12" (300mm).
- Use a condensation drain if necessary.

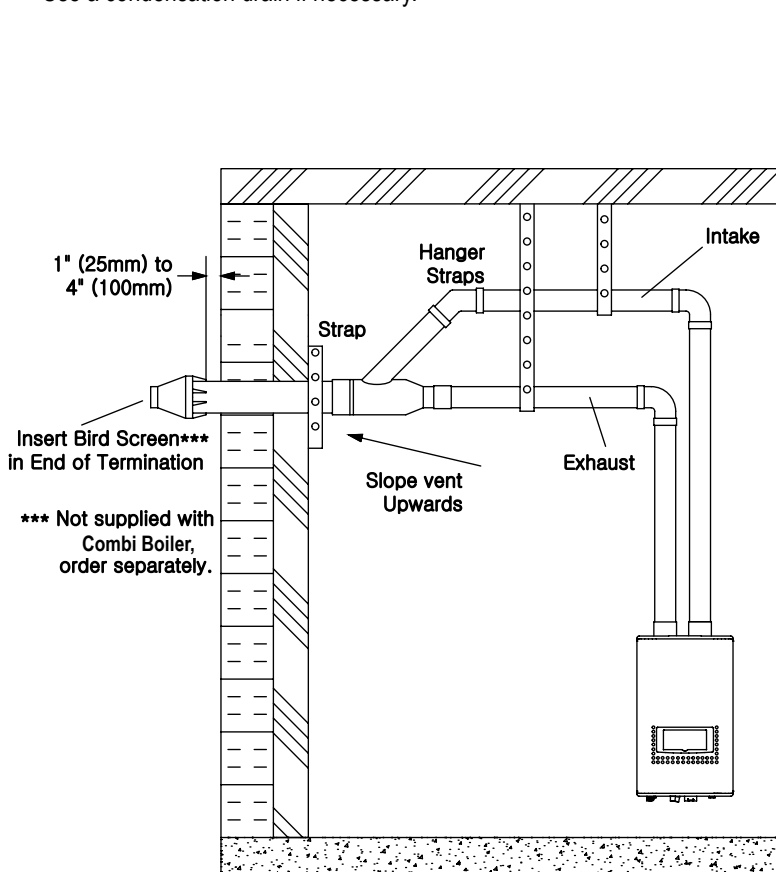

Horizontal

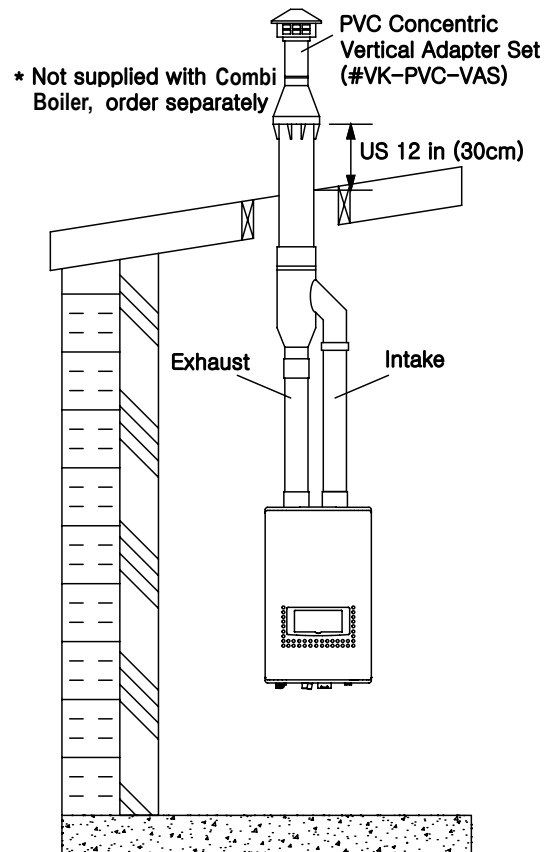

Vertical

Vent Pipe Installation (DV-Direct Vent)

■ **Horizontal Vent Termination- PVC/CPVC/PP Materials Only**

- * When 3' (0.9m) remote distance between Intake and Exhaust cannot be ensured.
- * Can not use Hood termination (PVT-HL)

- Intake and exhaust should face the same direction. Intake and exhaust should stay within the same pressure zone.
- Insert the bird screen. 90° elbow vertical setting (downward).
- Ensure at least 3ft (0.9m) or more distance between the near edge of the air intake pipe or exhaust pipe to the inside corner of a wall.
- Ensure at least 2ft (0.6m) or more distance between intake pipe and exhaust pipe. The distance is measured at inside of pipe to inner dimension.

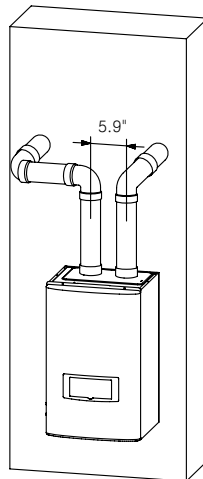

Interior View

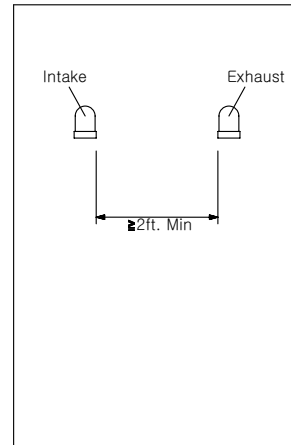

Exterior View

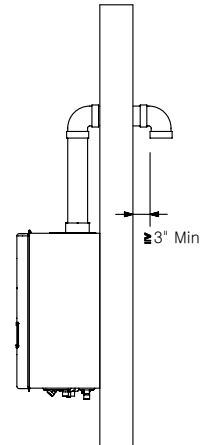

- Intake and exhaust should face the same direction. Intake and exhaust should stay within the same pressure zone.
- Insert the bird screen. 90° elbow vertical setting (downward).
- Ensure at least 3ft (0.9m) or more distance between edge of air intake pipe or exhaust pipe and corner wall.
- Upper side is exhaust, lower side is intake. The reverse orientation is not allowed.
- Ensure at least 1ft (0.3m) or more distance between intake pipe and exhaust pipe. The distance is measured at the outlets of intake port (terminal) and exhaust port (terminal).

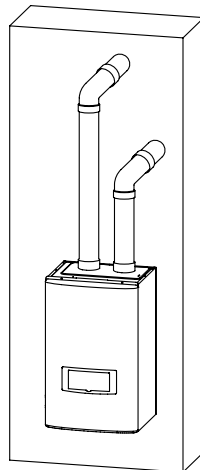

Interior View

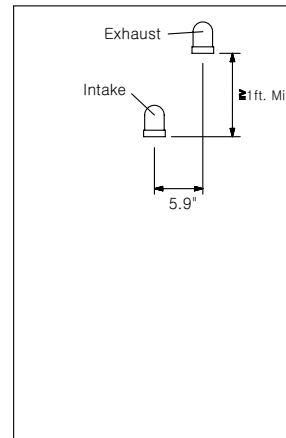

Exterior View

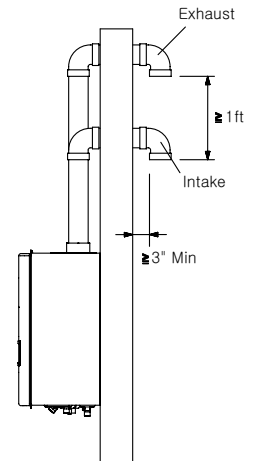

- Intake and exhaust should face the same direction. Intake and exhaust should stay within the same pressure zone.
- Insert the bird screen. 90° elbow vertical setting (downward).
- Ensure at least 3ft (0.9m) or more distance between edge of air intake pipe or exhaust pipe and corner wall.
- The pipe farther from the wall is intake, the side near the wall is exhaust. The reverse connection is not allowed.
- Ensure at least 1ft (0.3m) or more distance between intake pipe and exhaust pipe. The distance is measured at inside of pipe to inner dimension.

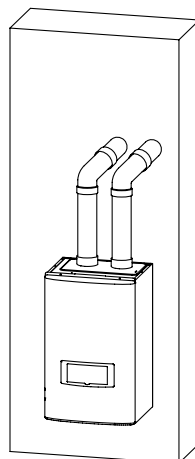

Interior View

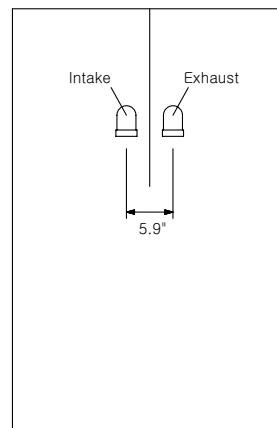

Exterior View

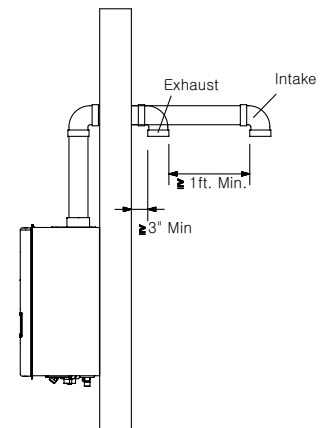

Vent Pipe Installation (SV-Non Direct Vent)

*** When supplying combustion air from the indoors (SV-CK-3 Conversion Kit is required)**

■ Horizontal Vent Termination- PVC/CPVC/PP Materials Only

- A tee, the PVT-HL termination may be used for the vent termination. It is not necessary to use bird screens with the PVT-HL termination.
- Terminate at least 12" (300mm) above grade or above snow line.
- Terminate at least 7' (2.1m) above a public walkway, 6' (1.8m) from the combustion air intake of any appliance, and 3' (0.9m) from any other building opening, gas utility meter, service regulator etc.
- Terminate at least 3' (0.9m) above any forced air inlet within 10' (3m) , 4' (1.2m) below, 4' (1.2m) horizontally from or 1' (0.3m) above any door, window, or gravity air inlet into any building per National Fuel Gas Code ANSI Z223.1/NFPA 54.
- Slope the horizontal vent 1/4" upwards for every 12" (300mm) toward the termination.
- Use a condensation drain if necessary.
- In the Commonwealth of Massachusetts a carbon monoxide detector is required for all side wall horizontally vented gas fuel equipment.

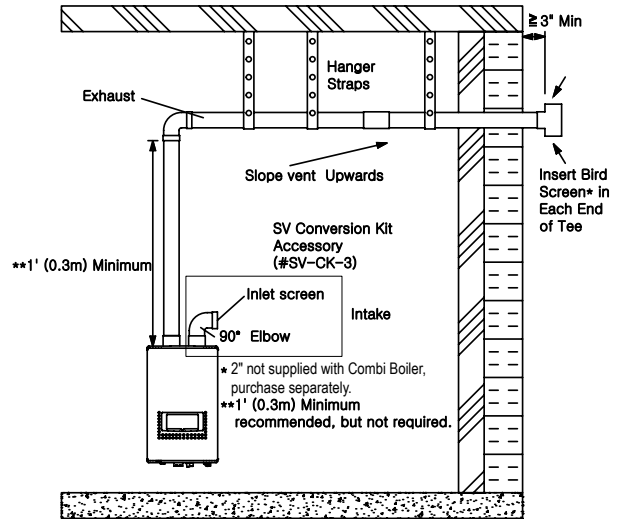

■ Vertical Vent Termination- PVC/CPVC/PP Materials Only

- Terminate at least 6' (1.8m) from the combustion air intake of any appliance, and 3' (0.9m) from any other building opening, gas utility meter, service regulator etc.
- Enclose exterior vent systems below the roof line to limit condensation and protect against mechanical failure.
- When the vent penetrates a floor or ceiling and is not running in a fire rated shaft, a firestop and support is required.
- When the vent termination is located not less than 8' (2.4m) from a vertical wall or similar obstruction, terminate above the roof at least 2' (0.6m), but not more than 6' (1.87m), in accordance with the National Fuel Gas Code ANSI Z223.1/NFPA 54.
- Provide vertical support every 3' (0.9m) or as required by the vent pipe manufacturer's instructions.
- A short horizontal section is recommended to prevent debris from falling into the Combi Boiler.
- When using a horizontal section, slope the horizontal vent 1/4" upwards for every 12" (300mm) toward the termination to drain condensate.

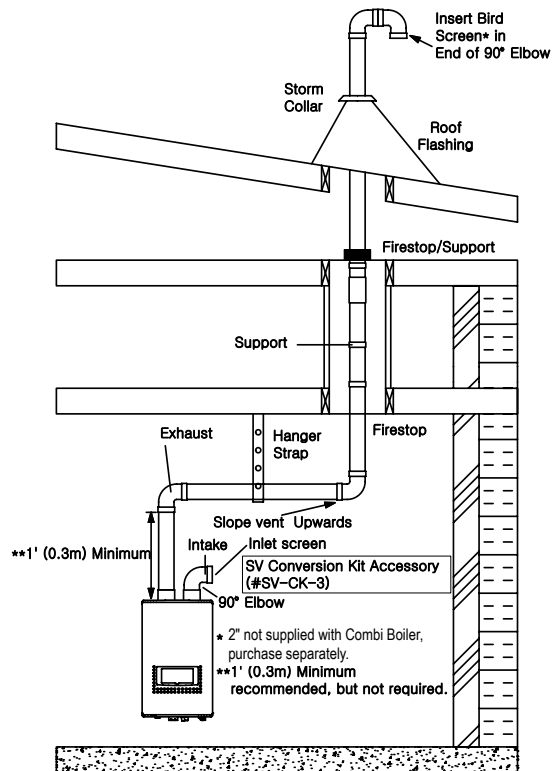

■ Provide adequate combustion air so as to not create negative pressure within the building.

- Provide two permanent openings to allow circulation of combustion air.
- Make each opening 199 square inches if they provide indoor air, and 100 square inches for outdoor air.
- If the unit is installed in a mechanical closet, provide a 24" (600mm) clearance in front of the unit to the door.
- If combustion air will be provided through a duct, size the duct to provide 60 cubic feet of fresh air per minute.

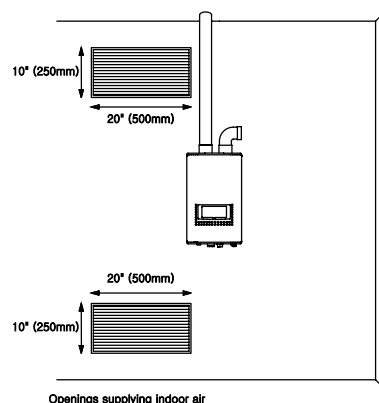

4-3. Setting the High Elevation

Elevation above Sea Level	7:EL setting
0~1,999ft (0~609m)	0 - 2
2,000~4,999ft (610~1,523m)	2 - 5
5,000~7,999ft (1,524~2,438m)	5 - 8
8,000~10,000ft (2,439~3,048m)	8 - 10

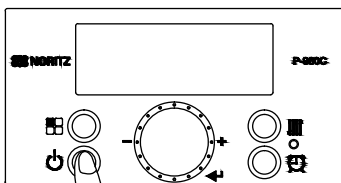

1. Turn off the power to control panel.

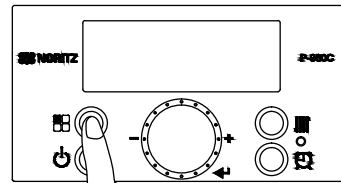

2. Press and hold the 'Function Button' for 5 seconds to get into the 'Installer Mode'. In 'Installer Mode', turn the dial button clockwise until the display reads '[7:EL]'. In 'Installer Mode', turn the dial button clockwise until the display reads '[7:EL]'.

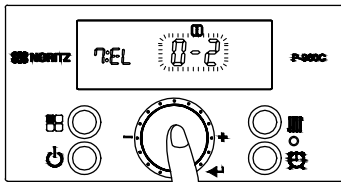

3. '0-2' will flash when the 'Dial Button' is pressed. (The default setting is '0-2' for installations at 0~1,999ft elevation.)

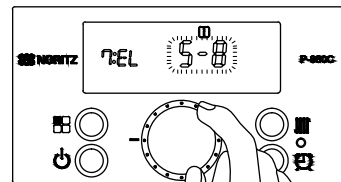

4. Turn the 'Dial Button' clockwise to select the value that corresponds to the installation elevation.

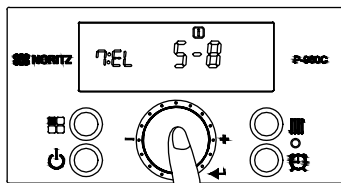

5. Press the 'Dial Button' to store the current setting and return back to 'Installer Mode'.

4-4. Gas Piping

In order to choose the proper size for the gas line, consult local codes or the National Fuel Gas Code ANSI Z223.1, CAN/CGA B149.1.

⚠ CAUTION

The guidelines and examples provided in this manual section are for reference only.

The sizing and installation of the gas system for this Combi Boiler, as with any gas appliance, is the sole responsibility of the installer. The installer must be professionally trained to do such work and must always follow all local and national codes and regulations. Gas line sizing calculations must be performed for every installation. Please contact Noritz America at 866-766-7489 if you have any questions or concerns.

Gas Type

The gas type indicated on the Combi Boiler rating plate (NG or LP) must match the type of gas being supplied to the Combi Boiler.

Gas Conversions

If the gas type supplied does not match the gas type on the rating plate, contact your Combi Boiler supplier for a replacement unit with the proper gas type. If a gas type conversion must be made, there are conversion kits available for some models. [The conversion kit shall be installed by a qualified service agency in accordance with the manufacturer's instructions and all applicable codes and requirements of the authority having jurisdiction. The qualified service agency is responsible for the proper installation of this kit. Improper installation of this kit will void the warranty. Conversion kits will only be shipped directly to the Distributor or Agency performing the conversion.]

Meter

The gas meter must be sized properly for the Combi Boiler and other gas appliances to operate properly. Select a gas meter capable of supplying the entire btu/h demand of all gas appliances in the building.

⚠ CAUTION

Regulators

Ensure that all gas regulators used are operating properly and providing gas pressures within the specified range of the Combi Boiler being installed. Excess gas inlet pressure may cause serious accidents.

⚠ CAUTION

Pressure

Check the gas supply pressure immediately upstream at a location provided by the gas company. Supplied gas pressure must be within the limits shown in the specifications section with all gas appliances operating. The inlet gas pressure must be within the range specified. This is for the purposes of input adjustment. Low gas pressure may cause a loss of flame or ignition failure at other appliances in the home, which may result in unburned gas in the home. Serious accidents such as fire or explosion may result.

Measuring Gas Pressure

In order to check the gas supply pressure to the unit, a tap is provided on the gas inlet. Remove the round head philips screw from the tap, and connect a manometer using a silicon tube.

In order to check the gas manifold pressure, a tap is provided on the gas valve inside the unit. The pressure can be checked either by removing the screw and connecting the appropriate pressure gauge.

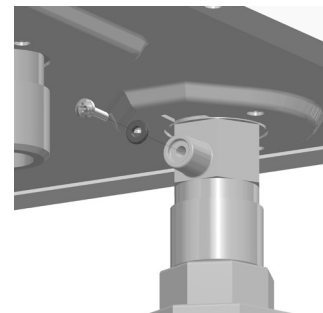

⚠ CAUTION**Pressure Test**

The appliance and its gas connections must be leak tested before placing the appliance in operation. The appliance must be isolated from the gas supply piping system by closing its individual manual shutoff valve during any pressure testing of the gas supply piping system at test pressures equal to or less than ½ psig (3.5 kPa). It is not recommended to pressure testing in excess of ½ psig (3.5kPa). If it must be done, the appliance and its individual shutoff valve must be completely disconnected from the gas supply piping system during the test process.

Pipe Sizing/Flexible Connectors

A gas shutoff valve must be installed on the supply line. Gas flex lines are not recommended unless the minimum inside diameter is ¾" or greater and the rated capacity of the connector is equal to or greater than the BTU capacity of the Combi Boiler. Gas piping shall be in accordance with local utility company requirements and/or in the absence of local codes, use the latest edition of National Fuel Gas Code (NFPA54GC), ANSI Z223.1. In Canada, use the latest edition of CSA B149.1, National Gas and Propane installation code. Size the gas line according to total Btu/h demand of the building and length from the meter or regulator so that the following supply pressures are available even at maximum demand.

Natural Gas Supply Pressure
Min 3.5" WC
Max 10.5" WC

LP Gas Supply Pressure
Min 8" WC
Max 14" WC

Reference Tools & Sample Calculations**⚠ CAUTION**

The tables and samples below are for reference only. The professional sizing and installing the gas line should always run the appropriate calculations before all installations..

Which Table to Use

- For NG installations with the initial supply pressure at point of delivery (at the meter, for example) is less than 8" WC, use the 0.5" WC pressure drop table (Table 1 on page 24).
- For NG installations with the initial supply pressure at point of delivery is greater than or equal to 8" WC, use the 3.0" pressure drop table (Table 2 on page 24).
- For all LP installation use (Table 3 on page 24)

The inlet pressure must be at least 5" WC for NG or 8" WC for LP for all appliances in the gas system. If the inlet gas pressure drops below 5" WC for NG or 8" WC for LP, the Combi Boiler may continue to operate, but the other appliances in the house may experience flame loss or ignition failure, which can result in gas leakage into the home. Refer to the NFPA 54 for details.

Please contact Noritz for details. For corrugated stainless steel tubing (CSST) capacity tables, please consult with the manufacturer.

Gas Line Sizing for a Noritz Condensing Gas Combi Boiler

Table 1. For Less than 8" WC initial supply pressure
Maximum Natural Gas Delivery Capacity (0.5" WC Pressure Drop)

Pipe size	Length (ft)										
	10'(3m)	20'(6m)	30'(9m)	40'(12m)	50'(15m)	60'(18m)	70'(21m)	80'(24m)	90'(27m)	100'(30m)	125'(37.5m)
3/4"	360	247	199	170	151	137	126	117	110	104	92
1"	678	466	374	320	284	257	237	220	207	195	173
1-1/4"	1390	957	768	657	583	528	486	452	424	400	355
1-1/2"	2090	1430	1150	985	873	791	728	677	635	600	532
2"	4020	2760	2220	1900	1680	1520	1400	1300	1220	1160	1020
2 1/2"	6400	4400	3530	3020	2680	2430	2230	2080	1950	1840	1630
3"	11300	7780	6250	5350	4740	4290	3950	3670	3450	3260	2890
4"	23100	15900	12700	10900	9660	8760	8050	7490	7030	6640	5890

Contact the Gas Supplier for Btu/Cubic Ft. of the Supplied Gas. 1000 BTU/Cubic Ft. is a Typical Value

Table 2. For 8" WC ~ 10.5" WC initial supply pressure
Maximum Natural Gas Delivery Capacity (3.0" WC Pressure Drop).

Pipe size	Length (ft)										
	10'(3m)	20'(6m)	30'(9m)	40'(12m)	50'(15m)	60'(18m)	70'(21m)	80'(24m)	90'(27m)	100'(30m)	125'(37.5m)
1/2"	454	312	250	214	190	172	158	147	138	131	116
3/4"	949	652	524	448	397	360	331	308	289	273	242
1"	1787	1228	986	844	748	678	624	580	544	514	456
1-1/4"	3669	2522	2025	1733	1536	1392	1280	1191	1118	1056	936
1-1/2"	5497	3778	3034	2597	2302	2085	1919	1785	1675	1582	1402
2"	10588	7277	5844	5001	4433	4016	3695	3437	3225	3046	2700
2 1/2"	16875	11598	9314	7971	7065	6401	5889	5479	5140	4856	4303
3"	29832	20503	16465	14092	12489	11316	10411	9685	9087	8584	7608
4"	43678	30020	24107	20632	18286	16569	15243	14181	13305	12568	11139

Table 3. Maximum Undiluted Propane (LP) Delivery Capacity in Thousands of Btu/H (0.5" WC Pressure Drop)

Pipe size	Length (ft)												
	10'(3m)	20'(6m)	30'(9m)	40'(12m)	50'(15m)	60'(18m)	80'(24m)	100'(30m)	125'(38m)	150'(45m)	175'(53m)	200'(60m)	250'(76m)
1/2"	275	189	152	129	114	103	96	89	83	78	69	63	55
3/4"	567	393	315	267	237	217	196	185	173	162	146	132	112
1"	1071	732	590	504	448	409	378	346	332	307	275	252	213
1-1/4"	2205	1496	1212	1039	913	834	771	724	677	639	567	511	440
1-1/2"	3307	2299	1858	1559	1417	1275	1181	1086	1023	976	866	787	675
2"	6221	4331	3465	2992	2646	2394	2205	2047	1921	1811	1606	1496	1260

** For reference only. Please consult gas pipe manufacturer for actual pipe capacities.

Noritz Condensing Gas Combi Boiler.
(CB199-DV: 199,000 Btuh)
(CB180-DV: 180,000 Btuh)

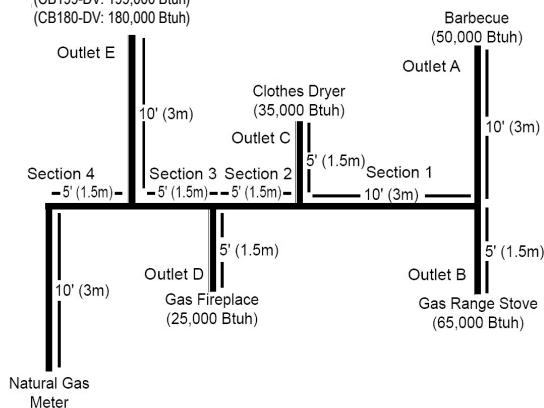

■ Instructions

1. Size each outlet branch starting from the furthest using the Btu/h required and the length from the meter.
2. Size each section of the main line using the length to the furthest outlet and the Btu/h required by everything after that section.

■ Sample Calculation

- Outlet A: 45' (13.5m) (Use 50' (15m)), 50,000 Btu/h requires 1/2"
- Outlet B: 40' (12m), 65,000 Btu/h requires 1/2"
- Section 1: 45' (13.5m) (Use 50' (15m)), 115,000 Btu/h requires 3/4"
- Outlet C: 30' (9m), 35,000 Btu/h requires 1/2"
- Section 2: 45' (13.5m) (Use 50' (15m)), 150,000 Btu/h requires 3/4"
- Outlet D: 25' (7.5m) (Use 30' (9m)), 25,000 Btu/h requires 1/2"
- Section 3: 45' (13.5m) (Use 50' (15m)), 175,000 Btu/h requires 1"
- Outlet E: 25' (7.5m) (Use 30' (9m)), 199,000 Btu/h requires 3/4" (CB199-DV)
180,000 Btu/h requires 3/4" (CB180-DV)
- Section 4: 45' (13.5m) (Use 50' (15m)), 374,000 Btu/h requires 1-1/4" (CB199-DV)
355,000 Btu/h requires 1-1/4" (CB180-DV)

** For reference only. Please consult gas pipe manufacturer for actual pipe capacities.

4-5. Water Piping

Installation must be performed by a qualified plumber. In the Commonwealth of Massachusetts, this product must be installed by a licensed plumber or gas fitter in accordance with the Massachusetts Plumbing and Fuel Gas Code 248 CMR Sections 2.00 and 5.00. Observe all applicable codes.

This appliance is suitable for combination potable water and heating applications. Do not use this appliance if any part has been underwater. Immediately call a qualified service technician to inspect the appliance and replace any part of the control system and gas control which has been under water.

If the Combi Boiler is installed with a return line that includes backflow preventer, such as one having a backflow preventer in the DHW cold water supply line, means shall be provided to control thermal expansion. Contact the water supplier or a local plumbing inspector on how to control this situation.

A pressure relief valve must be installed on the heating pressure relief connection and near DHW outlet that is rated in accordance with and complying with either the Standard for Relief Valves and Automatic Shutoff Devices for DHW Supply Systems, ANSI Z21.22, or ANSI/ASME Boiler and Pressure Vessel Code, Section IV (Heating Boilers). This pressure relief valve must be capable of an hourly Btu rated temperature steam discharge of 199,000 Btu/h. Multiple valves may be used. The pressure relief capacity in DHW pipe must not exceed 150 psig. (The pressure relief capacity on the heating pressure relief valve connection must not exceed 30 psig.) No valve shall be placed between the relief valve and the Combi Boiler. The relief valve must be installed such that the discharge will be conducted to a suitable place for disposal when relief occurs. No reducing coupling or other restriction may be installed in the discharge line. The discharge line must be installed to allow complete drainage of both the valve and the line. If this unit is installed with a separate storage vessel, the separate vessel must have its own temperature and pressure relief valve. This valve must also comply with The Standard for Relief Valves and Automatic Gas Shutoff Devices for DHW Supply Systems, ANSI Z21.22. (in the U.S. only). A temperature relief valve is not required, but if one is used, do not install the valve with the probe directly in the flow of water. This may cause unwarranted discharge of the valve.

DHW piping and components connected to the Combi Boiler shall be suitable for use with potable water. Toxic chemicals, such as those used for Combi Boiler treatment, shall not be introduced into the potable water. A Combi Boiler used to supply potable water may not be connected to any heating system or components previously used with a nonpotable water heating appliance.

When water is required in one part of the system at a higher temperature than in the rest of the system, means such as a mixing valve shall be installed to temper the water to reduce the scald hazard.

- Flush water through the pipe to clean out metal powder, sand and dirt before connecting it.
- Perform the following insulation measures for prevention of freezing.
 1. Take appropriate heat insulation measures (e.g., wrapping with heat insulation materials, using electric heaters) according to the climate of the region to prevent the pipe from freezing.
 2. Make sure that there are no water leaks from the cold and DHW supply pipes, then insulate the pipes completely.
 3. Be sure to also completely insulate the water supply valve and the cold and DHW connections on the Combi Boiler.
 4. Do not cover the water drain plug with insulation so that water in the pipe can be drained.
- Use a union coupling or flexible pipe for connecting the pipes to reduce the force applied to the piping.
- Do not use piping with a diameter smaller than the coupling.
- When the inlet water pressure is too high, insert a pressure regulating valve, or take water hammer prevention measure.
- Avoid using joints as much as possible to keep the piping simple.
- Avoid piping in which an air holdup can occur.
- If installing the unit in a attic:
 - About lower-level DHW supply.
 - If the unit is installed in a attic to supply water to the levels below, make sure that the water pressure supplied to the unit does not drop below 29 psi. It may be necessary to install a pump system to ensure that the water pressure is maintained at this level.
 - Check the pressure before putting the unit into operation.
 - Failure to supply the proper pressure to the unit may result in noisy operation, shorter lifetime of the unit, and may cause the unit to shut down frequently.

Supply water piping

- Do not use PVC, iron, or any piping which has been treated with chromates, Combi Boiler seal or other chemicals.
- Mount a check valve and a shut off valve (near the inlet).
- In order for the client to use the Combi Boiler comfortably, 14 to 70 PSI (98.1 to 491kPa) of pressure is needed from the water supply. Be sure to check the water pressure. If the water pressure is low, the Combi Boiler cannot perform to its full capability, and may become a source of trouble for the client.

Drain piping

- Expansion water may drop from the pressure relief valve and wet the floor. If necessary, provide drain piping or use a drain hose to remove the water.

DHW piping

- Do not use lead, PVC, iron or any piping which has been treated with chromates, Combi Boiler seal or other chemicals.
- The longer the piping, the greater the heat loss. Try to make the piping as short as possible.
- Use mixing valves with low water resistance. Use shower heads with low pressure loss.
- If necessary, use a pump or other means to ensure that the supply water pressure to the inlet of the Combi Boiler does not fall below 29 PSI when the maximum amount of water is being demanded. Also install a pressure meter on the inlet. If this is not done, local boiling will occur inside the Combi Boiler causing abnormal sounds and decreasing the durability of the heat exchanger.

Freeze Prevention

1. Unit

This Combi Boiler has functions to protect itself from freezing by operating the pump and turning on the burner when the thermistor detects lower than 46°F(8°C).

2. Heating System

- Freeze protection products may be used for the heating system. Freeze protection for new or existing systems requires specially formulated glycol, which contains inhibitors to prevent the glycol from attacking the metallic system components.
- Before using freeze protection products, ensure that system fluid contains proper glycol concentration and the inhibitor level is appropriate. Noritz recommends against exceeding a 35% concentration of glycol.
- When using the freeze protection products, the system must be tested at least once a year, and as recommended by the manufacturer of the glycol solution.
- When using the freeze protection products, allowance should be made for expansion of the glycol solution.
- Freeze damage is not covered by the warranty.

Electrical power, gas, water, and the main switch must be on. If any of the above items are not connected properly, then water must be drained including the condensation trap and unit unplugged from electrical power.

Water Treatment

If this Combi Boiler will be installed in an application where the supply water is hard, the water must be treated with either the Noritz H2Flow or Scale Shield or a water softener. Refer to the below tables for suggested treatment and maintenance measures to be taken based on the water hardness level. Damage to the Combi Boiler as a result of water in excess of 12 gpg (200 mg/L) of hardness is not covered by the Noritz America Limited Warranty.

Note: Water softeners may be regulated by the local water jurisdiction, consult with the manufacturer for code, sizing, and installation guidelines; the below diagram is for reference only. For more information about H2Flow and Scale Shield, contact Noritz America at 866-766-7489.

Residential Use Treatment Guidelines

Type of Water	Hardness Level	Treatment Device	Flush Frequency*
Soft	0-1 gpg (0-17 mg/L)	None	None
Slightly Hard	1-3 gpg (17-51 mg/L)	None	None
Moderately Hard	3-7 gpg (51-120 mg/L)	H2Flow or ScaleShield	Once a Year**
Hard	7-10 gpg (120-171 mg/L)	H2Flow or ScaleShield	Once a Year**
Very Hard	10-14 gpg (171-239 mg/L)	H2Flow	Treatment Required
Extremely Hard	> 14 gpg (> 239 mg/L)	H2Flow	Treatment Required

* Install Noritz Isolation Valves to allow for flushing.
 ** Flushing is required if a water treatment device is not installed.

Water Treatment System

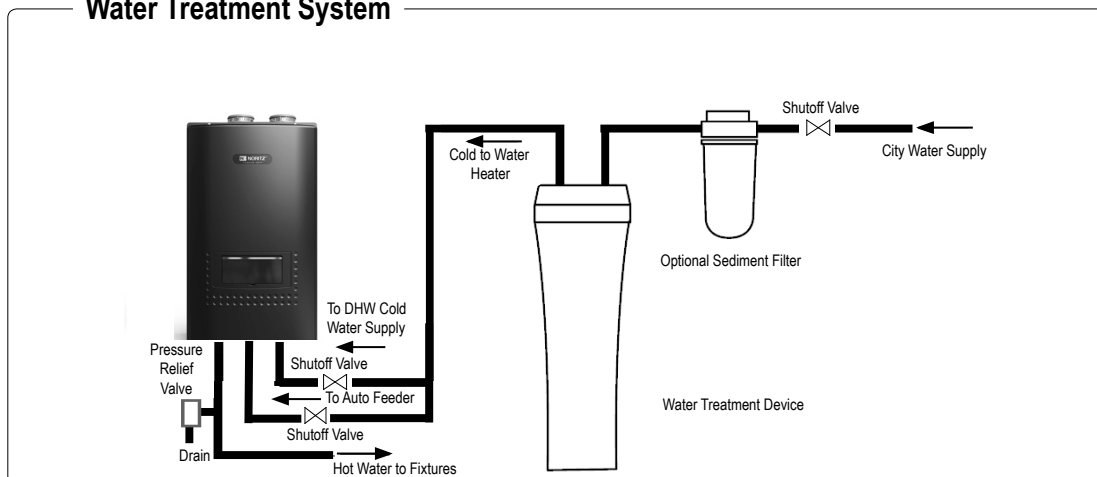

4-6. Heating Installation

■ System Pressure

The Combi Boiler is intended solely for use in pressurized closed loop heating systems operating with 12-30 psi water pressure at the Combi Boiler outlet.

To obtain the minimum system design pressure, follow the piping diagrams illustrated in this section.

The Combi Boiler's Heating system is not approved for operation in an 'open system', thus it cannot be used for direct potable water heating or to process heating of any kind.

■ Backflow Preventer

Install a backflow preventer valve in the make-up water supply to the unit as required by local codes.

■ Expansion Tank

An expansion tank must be installed in the heating piping to prevent excessive pressure from building in the system.

See the examples of system application at the end of this section for the installation location.

Refer to the expansion tank manufacturer's instructions for additional details.

Follow the guidelines below when installing an expansion tank.

- Connect an air separator to the expansion tank only if the air separator is located on the suction side of the system circulator.
- The Combi Boiler is equipped with an auto-feeding water connection and motorized feeding valve. Therefore, installation of additional system water fill connection is not necessary in most cases.
- If an additional water fill connection is required for a specific use, install the water fill connection at the same location as the expansion tank's connection to the system.
- When replacing an expansion tank, consult the expansion tank manufacturer's literature for proper sizing.
- For diaphragm expansion tanks, always install an automatic air vent on the top side of the air separator to remove residual air from the system.

■ Oxygen Elimination

This Combi Boiler may only be installed in a pressurized closed-loop heating system, free of air (oxygen) and other impurities.

To avoid the presence of oxygen, ensure all of the air is removed from the system during commissioning via strategically placed and adequately sized air removal devices, located throughout the heating system.

⚠ WARNING

Immediately repair any leaks in the system plumbing to avoid the addition of make-up water; make-up water provides a source of oxygen and minerals that may lead to heat exchanger failure. Failure to follow these instructions will result in poor performance, unnecessary wear of system components and premature failure

CB199-DV / CB180-DV Pump Performance
(with internal pressure drop)

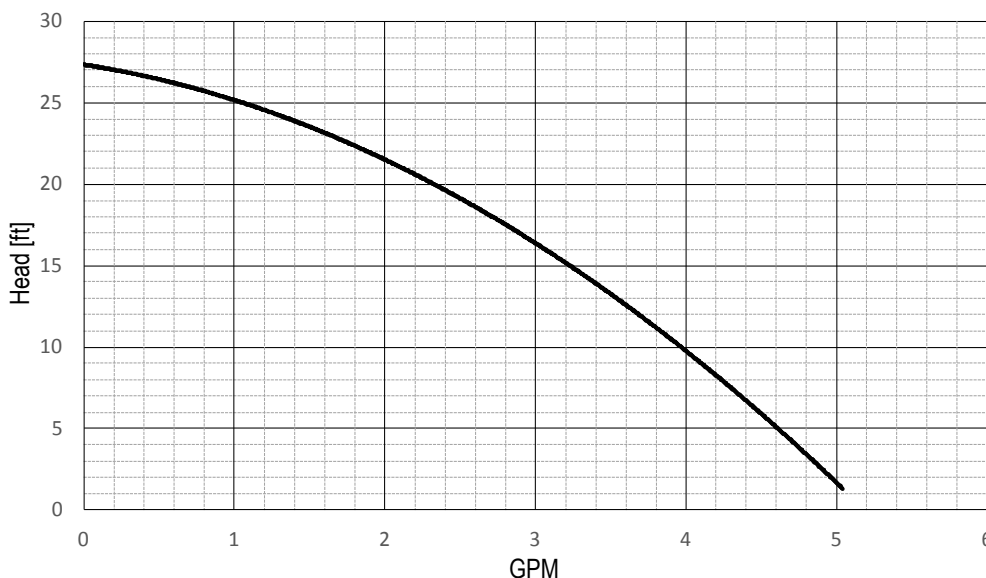

4-7. Low Water Cutoff (LWCO)

■ Internal of the Combi Boiler

The Noritz Combi Boiler is equipped with a factory installed, pressure sensor type low water cutoff device.

The lowest operation pressure for this device is 8psi. (operation pressure = (default valve 12psi) - (4psi))

- The Combi Boiler performs water replenishment automatically when the built-in water pressure sensor detects insufficient water level in the Combi Boiler system.

■ External of Combi Boiler

- Low water cutoffs shall comply with the Safety Standard for Limit Controls, ANSI/UL 353, or the Standard for Temperature Indicating and Regulating Equipment, CAN/CSA C22.2, No. 24, as applicable. The following figure illustrates an example of typical LWCO installation.

- Install the probe above the minimum safe water level, as determined from the Combi Boiler manufacturer's literature.

NOTE: This may be in a tapping on the Combi Boiler or in the Combi Boiler supply or return piping.

- Install the probe to extend into the Combi Boiler cavity or piping to make contact with the water.
- Low water cutoffs shall be located so as to provide adequate access for cleaning, repairing, testing and inspection.

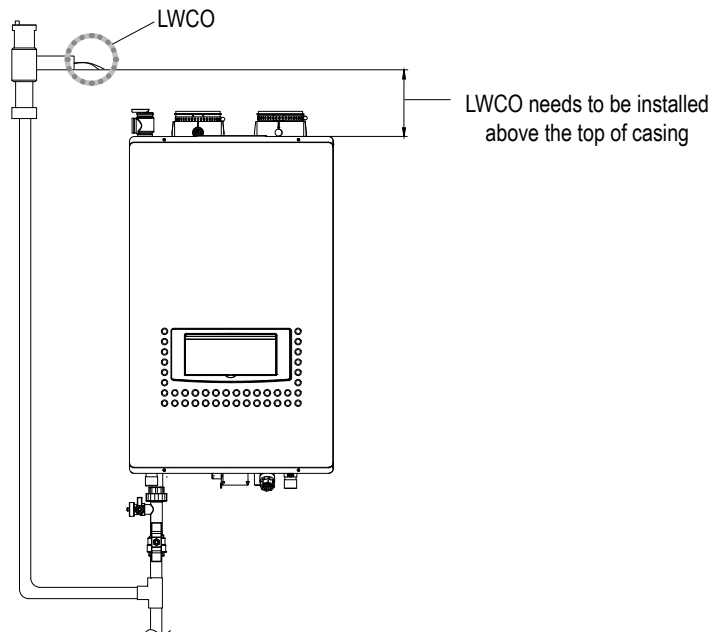

- Remove the factory installed jumper on the LWCO terminals (CN22) prior to connecting the LWCO
- The Combi Boiler supplies 24 VAC from the terminal CN17 #5 and #6 (see below illustration).

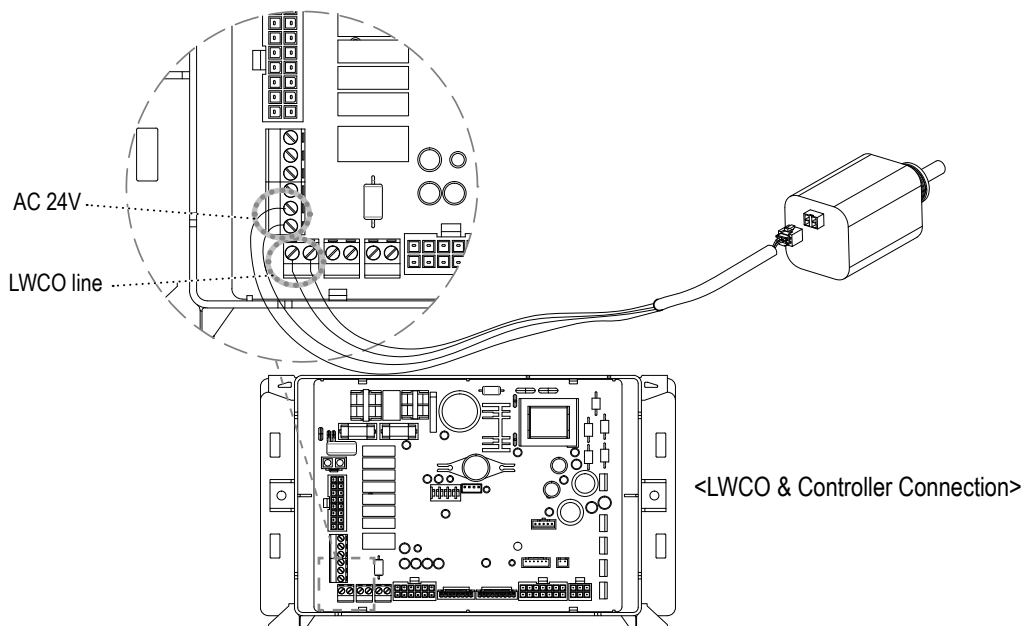

4-8. Pressure Relief Valve

- External pressure relief valve must be installed. Observe the following. Failure to comply with the guidelines on installing the pressure relief valve and discharge piping can result in personal injury, death or substantial property damage.
- DO NOT install a relief valve (DHW pipe line) with pressure higher than 150psi and relief valve (Heating pipe line) with pressure higher than 30psi. This is the maximum allowable relief valve setting for the Combi Boiler.
- Approved 'Pressure Relief Valve' should be applied. An approved ASME HV Valve must be installed on the DHW supply line for hydronic domestic hot water loop as close to the unit as possible. (Valve size 3/4" , maximum 150psi)
Refer to the figure below for more information on approved pressure relief valves.
(Install 'pressure relief valve', which can be purchased from local wholesaler.)
- No other valve should be installed between the pressure relief valve and Combi Boiler.
- Direct the discharge piping of the pressure relief valve so that hot water will not splash on anyone or any nearby equipment. Attach the discharge line to the pressure relief valve and run the end of the line to within 6-12" (150-300mm) of the floor.
- Isolation valve set should be installed, which can be purchased from local wholesaler.

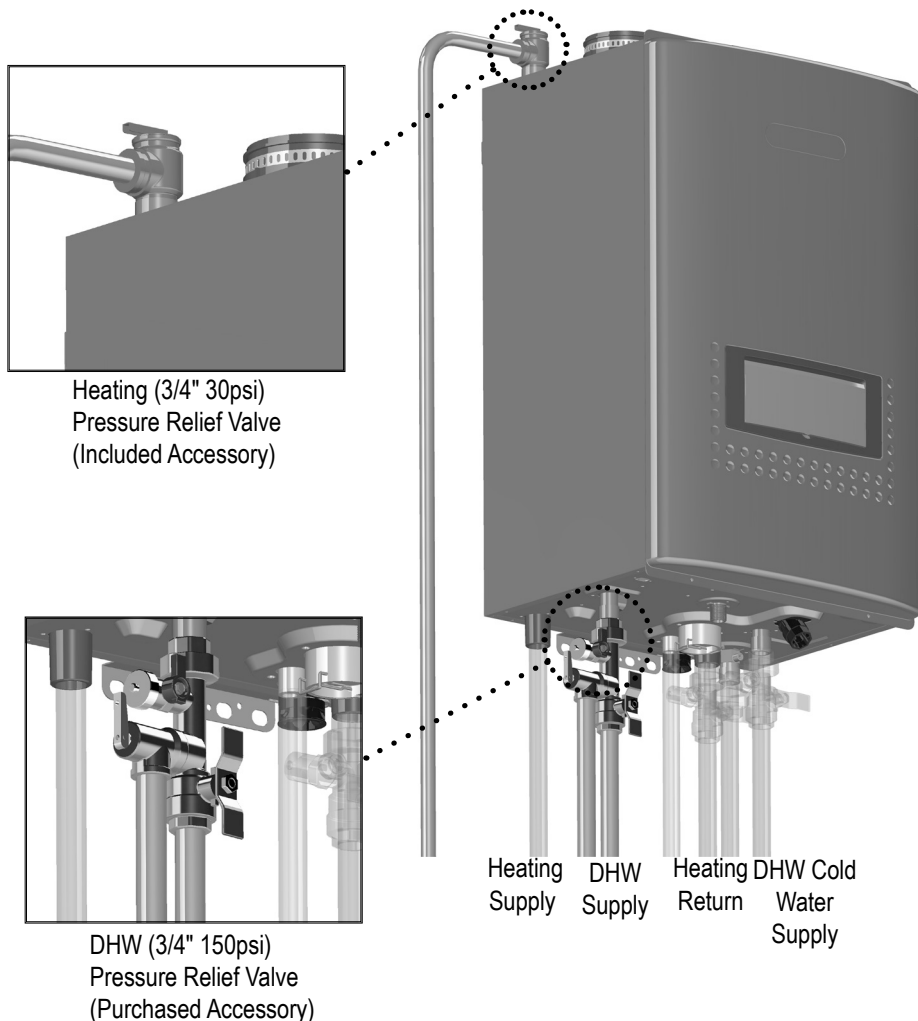

Auto Feeder Connection

- Before filling the Combi Boiler, loosen the air vent cap to allow the system to fill properly. Tighten the cap when the system is full.

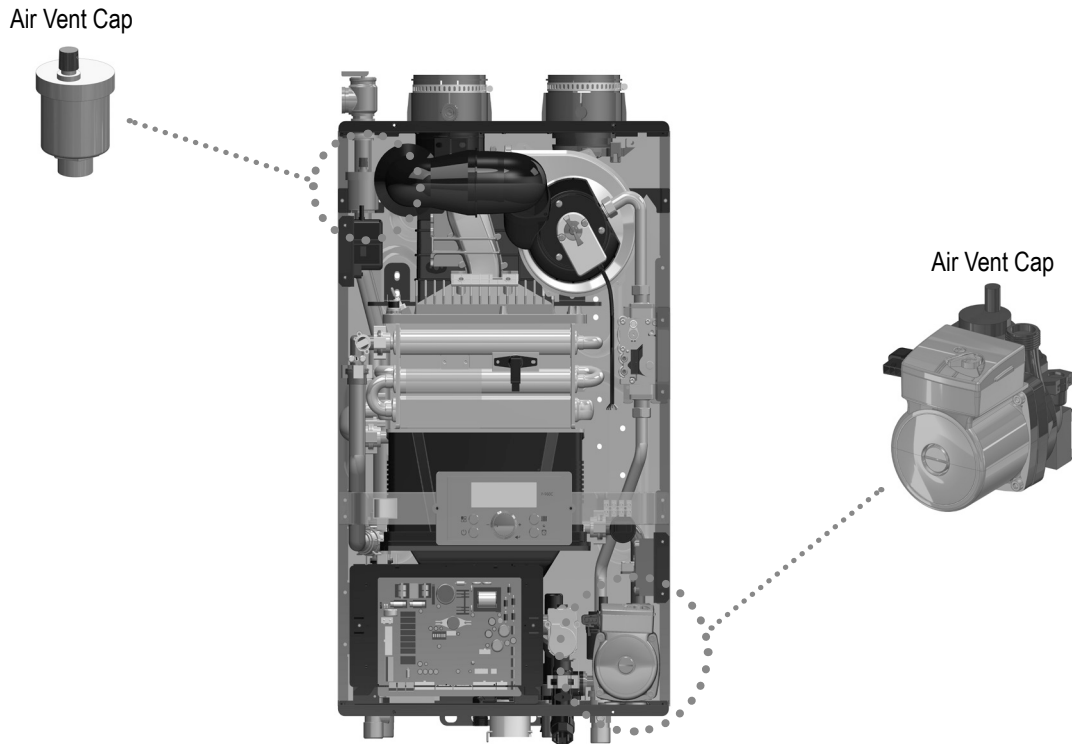

- The Combi Boiler is equipped with an auto feeder valve. Therefore, installation of additional system water fill connection is not necessary in most cases. See the following figure for an example of a water fill installation using the built-in connection.

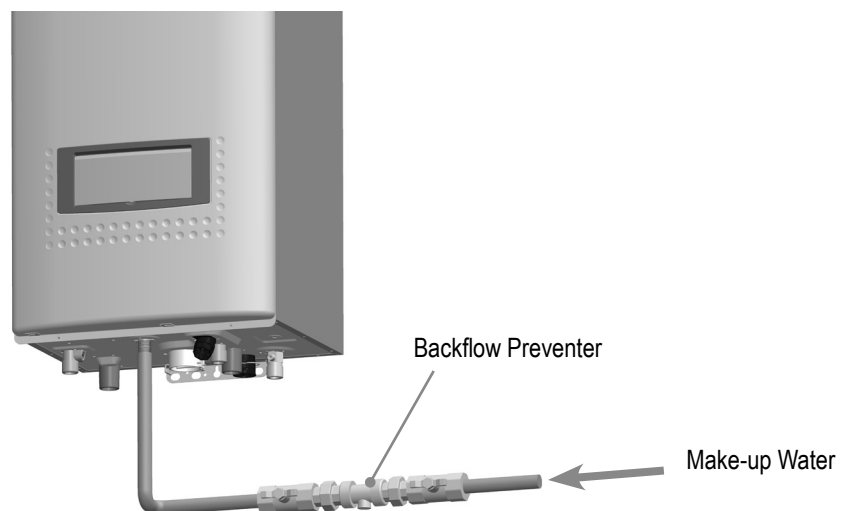

- External water feeder may be installed on the system piping if it is required for specific applications. See the following figure for an example of external water feeder installation on the system piping.

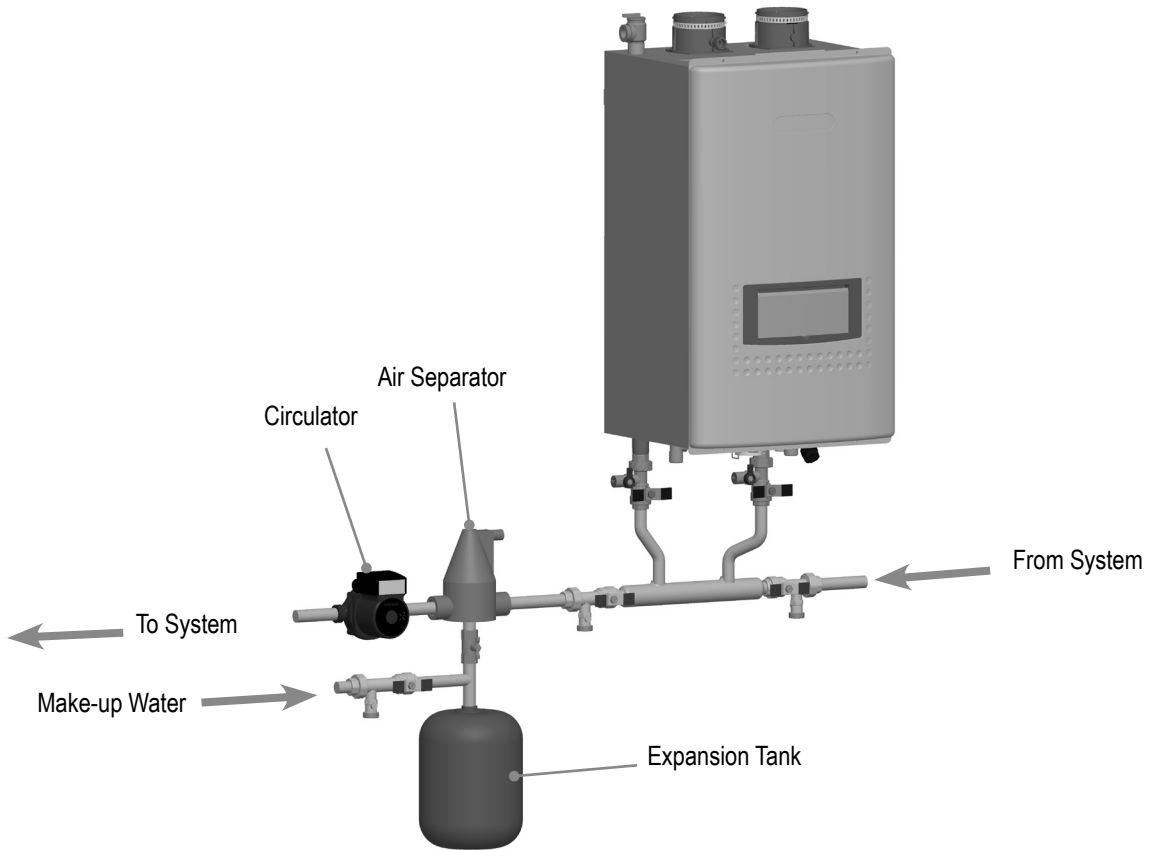

4-9. Condensate Piping

⚠ CAUTION

Due to the acidic nature of the condensate, be sure to properly drain and if necessary, treat the condensate prior to disposal. Damage caused by improperly handled condensate is not covered by the warranty.

- This Combi Boiler is a high efficiency, fully condensing appliance which produces acidic condensate during operation. The Combi Boiler incorporates a collection and removal system which must be properly drained in order to ensure proper operation of this appliance.
- The pH level of the condensate is approximately 2-3. An external neutralizer must be installed on the drain piping prior to disposal when required by local code or when the condensate could cause damage.
- If an external neutralizer is installed, periodic replacement of the neutralizing agent will be required. Refer to the instructions supplied with the neutralizer for suggested replacement intervals.
- In order to drain the condensate, a 1/2" threaded fitting is provided at the base of the Combi Boiler. Do not reduce the size of this fitting or the drain piping to less than 1/2". In cold climates, do not drain the condensate to the outdoors. If the drain pipe freezes during cold weather, the pipe will not drain condensate and the unit will stop operating.
- Use plastic pipe, such as PVC, for the drain line. Do not use steel, black iron, or any other material which can corrode when placed into contact with acidic condensate.
- Keep the length of the drain pipe as short as possible. Long runs or applications where the nearest drain is above the Combi Boiler will require the use of a condensate pump. Size the pump to allow for a maximum condensate discharge of 2 GPH from the Combi Boiler.
- Horizontal runs must be sloped 1/4" per foot towards the drain or condensate pump. The condensate will be discharged by gravity force only. Make the drain pipe run as short as possible.
- The end of the drain pipe must not be submerged in water or blocked in any way. To ensure proper drainage, leave the end of the drain pipe open to the atmosphere. Do not have a trap. Also, make sure that there are no obstructions blocking the drain line from discharging condensate.
- Be sure to check that condensate is freely flowing from the drain piping after the system has been installed. Condensate will begin flowing out of the Combi Boiler within 15 minutes after operation has started.
- Take measures to prevent the condensate drain lines from freezing (insulation, heat tape, electric heaters, etc.).
- The bottom of the Combi Boiler must be higher than the top of the laundry tub to use this option. The condensate drain pipe must have a negative slope to drain properly.

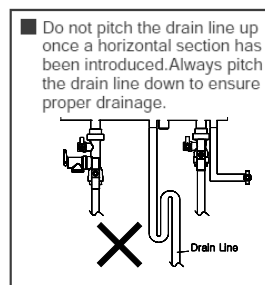
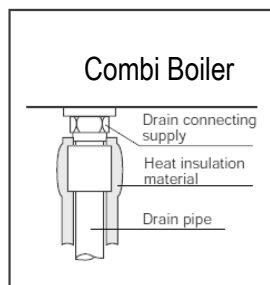

Condensate piping to floor drain

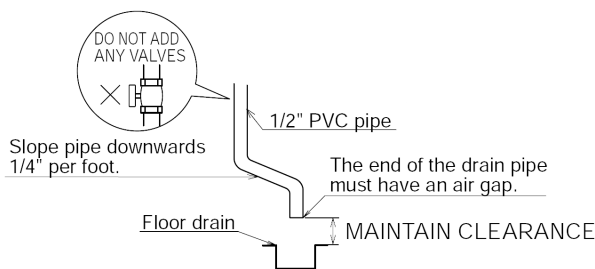

Condensate piping with pump

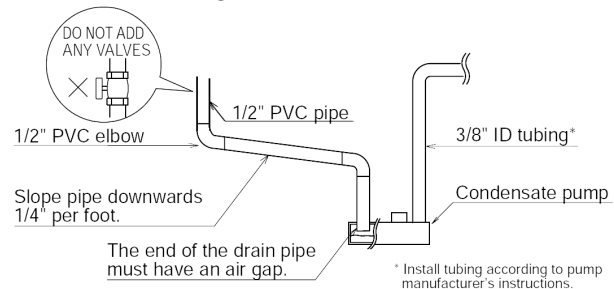

Note:

If the drain line becomes clogged or frozen, condensate will back-up into the Combi Boiler and a "29" error code will flash on the display window, ceasing operation. If this occurs, clear the clog or freeze so that condensate can freely flow. Be sure to slope the drain pipe, use the appropriate size pipe, allow the proper clearances, and apply freeze prevention measures (when necessary) to prevent the drain line from clogging or freezing..

4-10. Electrical Wiring

Do not connect electrical power to the unit until all electrical wiring has been completed.

Do not connect electrical power to the unit until all electrical wiring has been completed.

This appliance must be electrically grounded in accordance with local codes, or in the absence of local codes, with the National Electrical Code, ANSI/NFPA 70. In Canada, the latest CSA C22.1 Electrical Code.

Caution: Label all wires prior to disconnection when servicing controls. Wiring errors can cause improper and dangerous operation.

Verify proper operation after servicing.

Field wiring to be performed at time of appliance installation.

⚠ WARNING**Electrical Shock Hazard**

Do not turn power on until electrical wiring is finished. Disconnect power before servicing. Failure to do so may result in death or serious injury from electrical shock

- The electrical supply required by the Combi Boiler is 120VAC at 60 Hz. The power consumption may be up to 180W/187W. (Model: CB180-DV/ CB199-DV), (External Pump: 120VAC Max 2A)

Use an appropriate circuit.

- Do not disconnect the power supply when not in use. When the power is off, the freeze prevention in the Combi Boiler will not activate, resulting in possible freezing damage.
- The electrical supply must be connected by designated power circuit.
- Do not let the power cord contact the gas piping.

Tie the redundant power cord outside the Combi Boiler. Putting the redundant length of cord inside the Combi Boiler may cause electrical interference and faulty operation.

Ground

- To prevent electrical shock, provide a ground with resistance less than 100Ω . An electrician should do this work.
Do not connect the ground to the city water or gas piping. Do not tie the ground to a telephone line.

Breaker Installation

- Mount a device which shuts off the electrical path automatically (leakage breaker) when electrical leakage is detected.

⚠ CAUTION

Electrostatic discharge can affect electronic components. Take precautions to prevent electrostatic discharges from personnel or hand tools during the Combi Boiler installation and servicing to protect product's electronic control.

⚠ CAUTION

Do not disconnect the electric power, gas and inlet water supply when not in use. If any of these item are not properly connected freezing damage may occur. In this case, please drain all of water in the unit including condensate trap and unplug the unit.



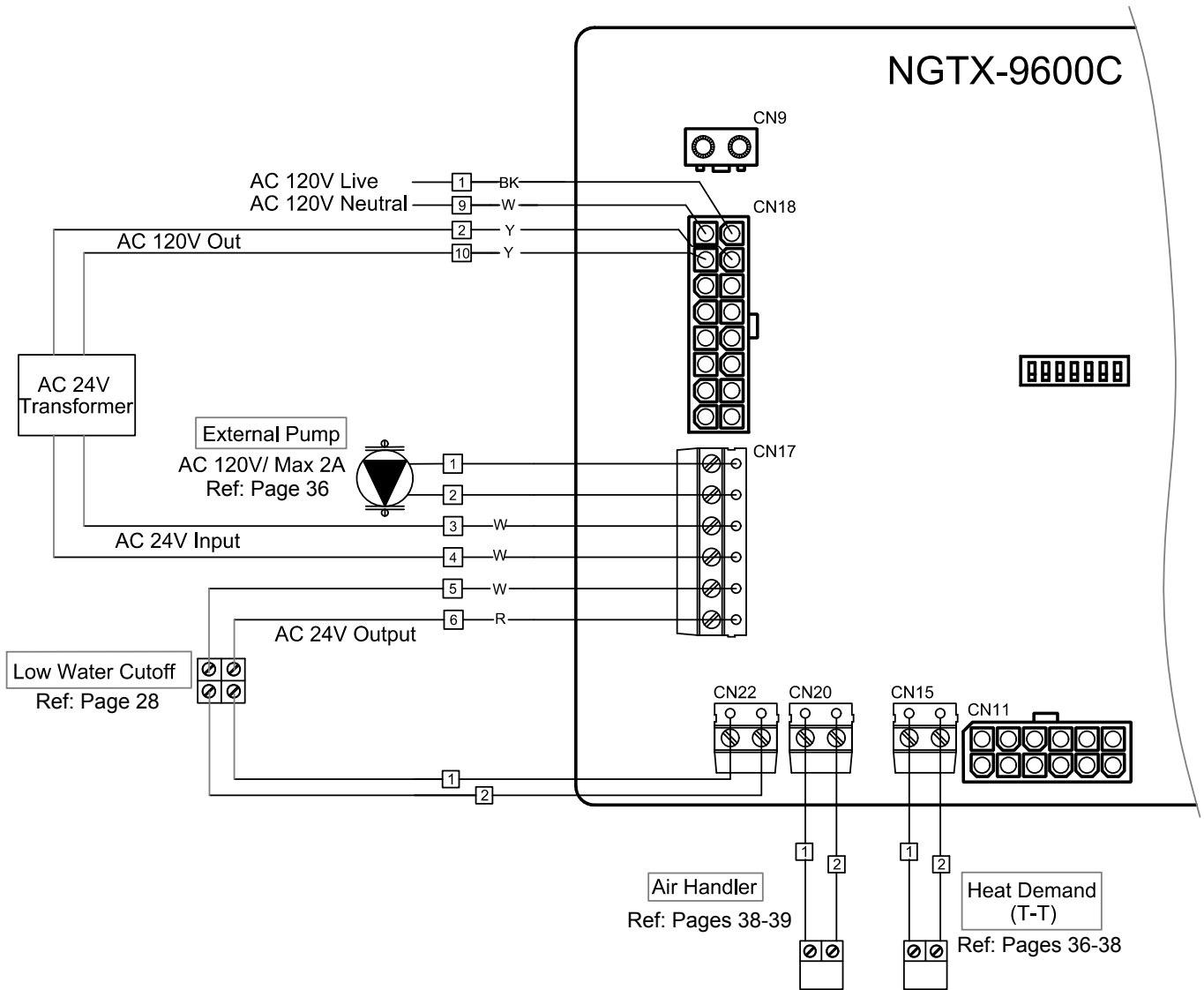







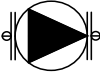

4-11. Wiring Diagram for External Options



Note:
 * 1 External Pump Terminal : '10:EP' should be 'on' in Installer Mode to activate this terminal.
 * 2 Air Handler Terminal : '8:AH' should be 'on' in Installer Mode to activate this terminal.

4-12. Plumbing Guidelines

Piping Symbol

	Gate valve		External pump		Pressure relief valve
	Expansion tank (Closed type)		Isolation valve		Air Separator
	Mixing Valve		Swing check valve		Pressure Reducing Valve
	Zone Valve		Ball valve		Backflow preventer
	Circulator (w/integral check valve)				

1. This drawing is meant to show system piping concept only. Installer is responsible for all equipment and detailing required by local codes.
2. All closely spaced tees shall be within 4 pipe diameters center to center spacing.
3. A minimum of 6 pipe diameters of straight pipe shall be installed upstream and downstream of all closely spaced tees.
4. The minimum pipe size of DHW piping should be ¾" diameter and Heating piping should be 1" in diameter.
5. Piping shown is Primary/Secondary. System flow (secondary loop) must be greater than the appliance's primary loop flow.
6. Install a minimum of 12 diameters of straight pipe upstream of all circulators.
7. In a valve-based system, each heating zone has a zone valve which opens when that zone calls for heat. Each zone thermostat is wired to its corresponding zone valve. Contacts in the zone valves provide a signal to the appliance to operate when there is a call for heat.
8. Unit is equipped with built-in primary pump for the heating loop. This pump is sized to insure proper flow rate through the appliance heat exchanger and related piping. On long pipe runs, it is recommended to keep the pump at maximum speed (setting 3). DO NOT lower it from the factory default.
9. Install a backflow preventer valve in the make-up water supply to the unit as required by local codes.

1. Primary/Secondary Piping with Zone Valves

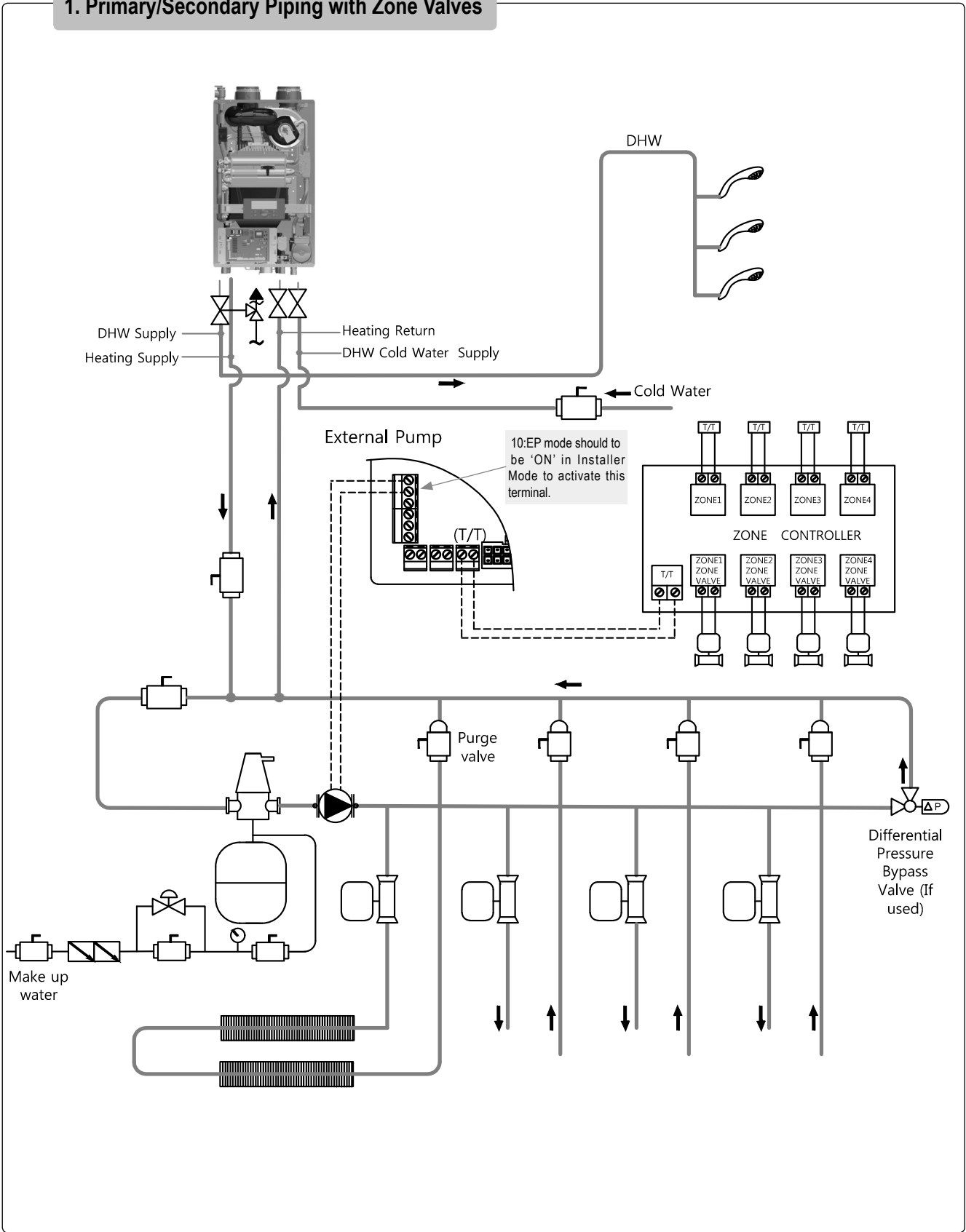

2. Primary/Secondary Piping with Zone Pumps

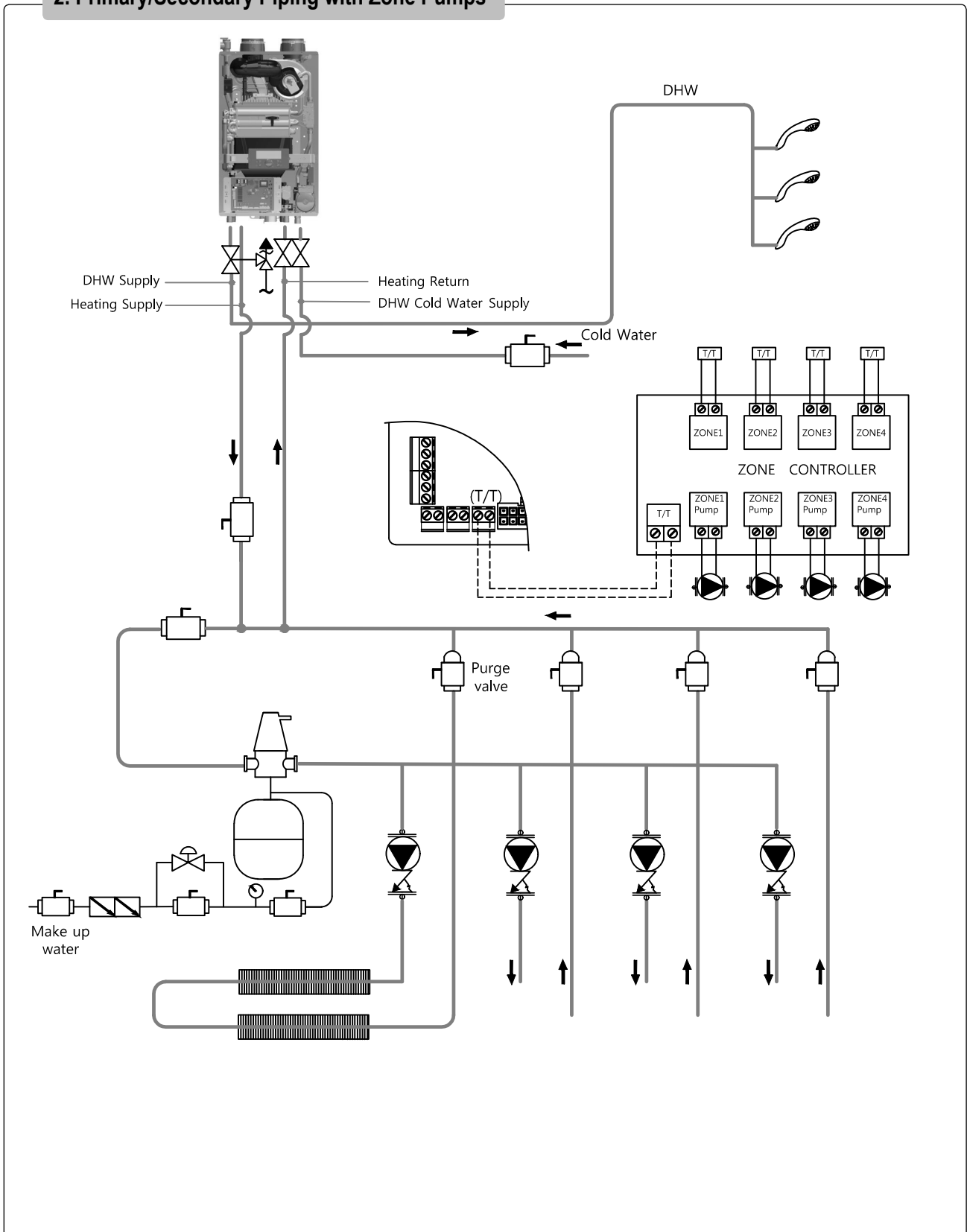

4-13. Air Handler

- The Noritz Combi Boiler can control the operation of an Air Handler when a thermistor is used in combination with the Air Handler. The Air Handler function is designed to stop the Air Handler's pump and fan operation when the Combi Boiler's heating function is not operating due to DHW operation, Combi Boiler errors or Low Water in the Combi Boiler.
- The Air Handler turns off when the following conditions arise:
 - Thermistor open or short.
 - The Combi Boiler is supplying DHW, or it is in stand-by for DHW mode.
 - The Combi Boiler is turned off.
 - Make-up water (Auto feed mode) is in progress.
 - In order to set up the Air Handler, from Installer Mode 8:AH mode should be activated. (Refer to page 39 of Installation Manual)

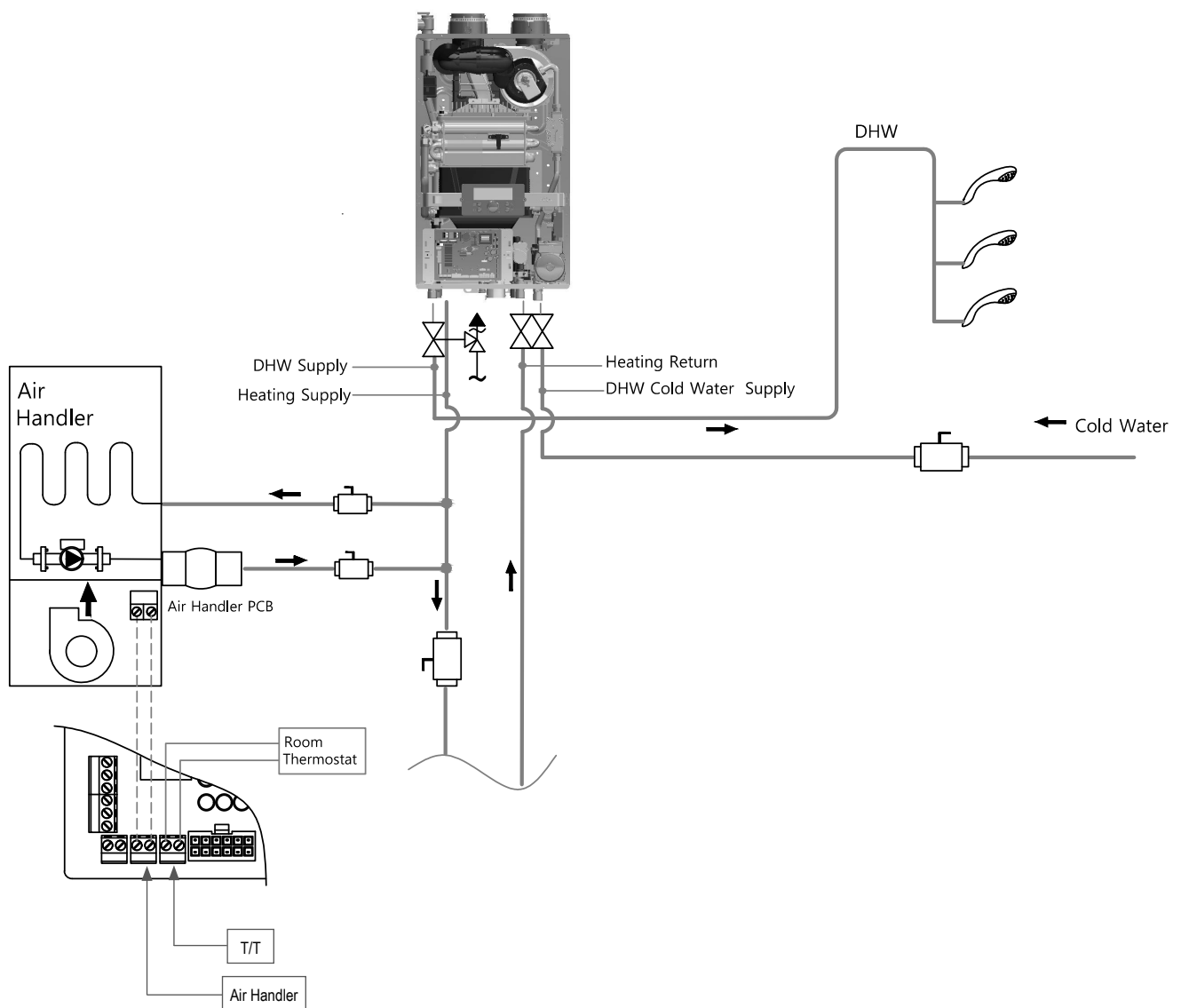

How to activate the Air Handler Terminal.

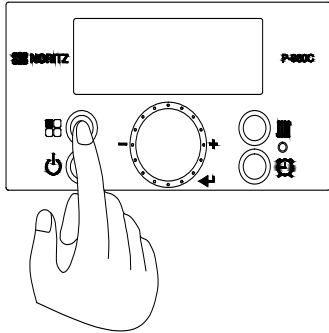

1. Turn off the power to the control panel. Press and hold the 'Function Button' for approximately 5 seconds to get into the 'Installer Mode'.

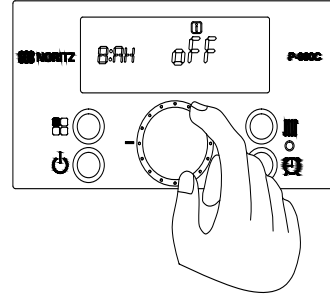

2. Turn the 'Dial Button' clockwise to 8:AH.

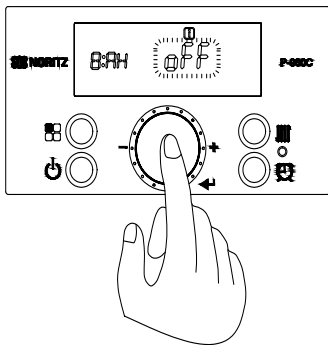

3. Press the 'Dial Button' so 'oFF' is blinking. Then turn the 'Dial Button' clockwise so 'on' is blinking.

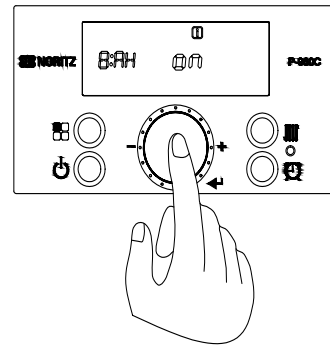

4. Press the 'Dial Button' to save the setting. If you would like to move to next function in the 'Installer Mode', turn the 'Dial Button' clockwise or to exit 'Installer Mode' press the 'Function Button'.

4-14. Trial Run - Auto Feeder Process.

1. Turn on the power to the control panel.
2. Automatic water replenishment in progress when the Combi Boiler is less than the internal pressure 12psi.

Note) 'Error Code 54' will be indicated at the beginning of auto feeding.

This is normal operation. When auto feeding is complete, 'Error Code 54' turns off automatically.

- 1) When the Combi Boiler's water pressure is below of a certain point, then the 3-Way Valve will be switched to the plate heat exchanger and add water.

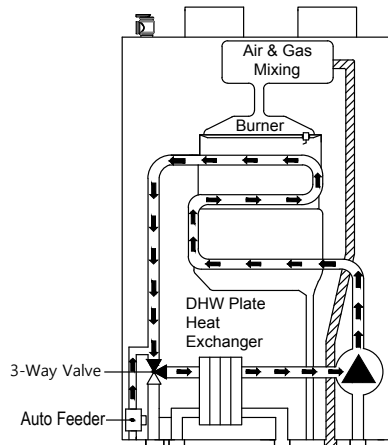

- 2) When the water filling is finished, then the 3-Way Valve will be switched to heating supply pipe and proceed to add water to increase the pressure on the heating loop.

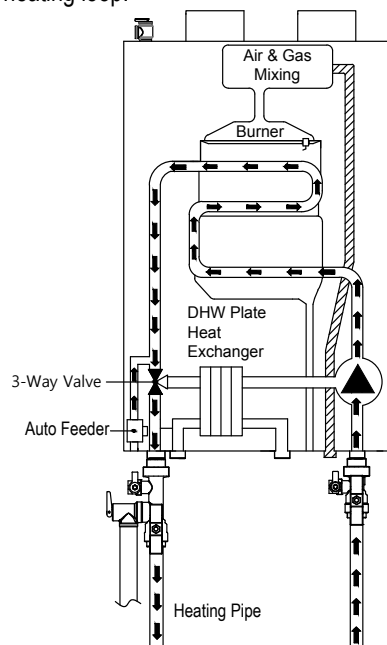

- 3) If the water adding is done up to a certain pressure within the heating pipe, then the circulation pump will operate in order to add water in the heating pipe.
- 4) When the heating loop reaches the set pressure, then the 3-Way Valve will switch to the plate heat exchanger and re-check the water pressure. After, the 3-Way Valve will re-check the heating loop.
- 5) Repeat the operation and stop processes of the circulation pump of the 1st 5 minutes of the heating loop air purge.
- 6) Repeat the operation and stop processes of the circulation pump of the 2nd 10 minutes of the heating loop air purge. Then, stop the trial run.

5-1. Outdoor Temperature Reset

- The Outdoor Reset Control feature may be used to enhance energy efficiency while maintaining optimal heating performance. With the Outdoor Reset Control, the heating temperature setting automatically changes according to the outdoor temperature and the current heating system application.
- There are various pre-defined temperature range options available to assist matching the system heat load with the applicable outdoor temperature range.
- The built in outdoor reset control provides simple heating curve selection based upon pre-defined Combi Boiler set temperature ranges determined by the type of heating application. This can be adjusted either by selecting the appropriate menu option, or by utilizing the fully customizable mode.

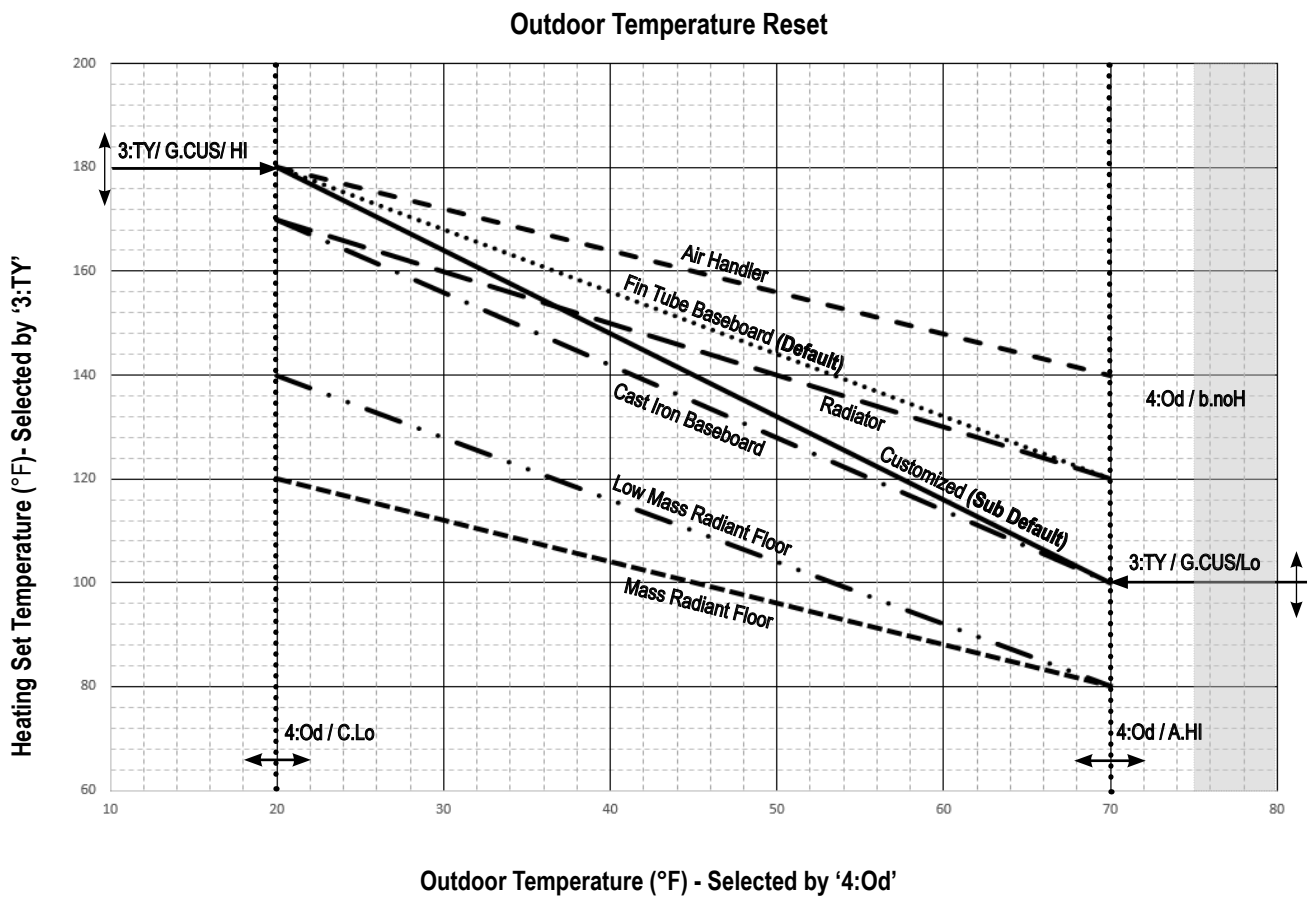

Note:
 The optimal set up should be determined for each job location.
 Default setting: Max Temperature: 180 °F, Min Temperature: 120°F

■ Setting the 'Outdoor Temperature Reset Mode'. [2:TR]

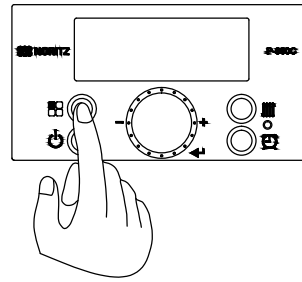
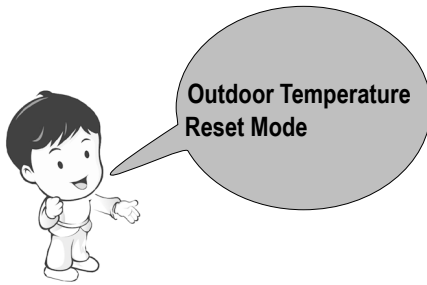

1. Connect outdoor sensor to terminal.
(Refer to page 46 of the Installation Manual for additional detail)

2. Turn off the power to control panel. Press and hold the 'Function Button' for approximately 5 seconds to enter the 'Installer Mode'.

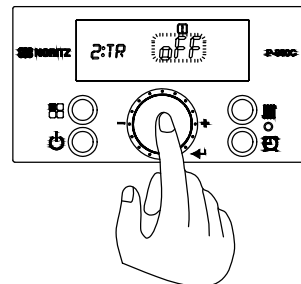
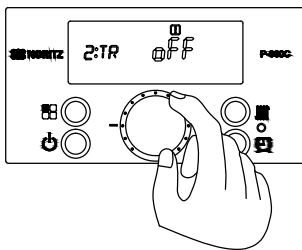

3. Turn the 'Dial Button' clockwise until '[2:TR]' is displayed.

4. Press the 'Dial Button'. OFF will begin blinking. Turn the 'Dial Button' from OFF to ON.

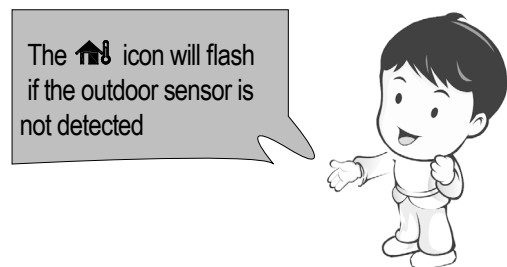
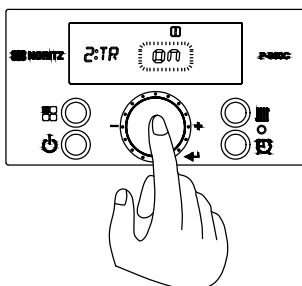

5. Press the 'Dial Button' to save the setting. Additional menu items will become available to adjust.

NOTE:

- Installer Mode 2:TR : Outdoor Temperature Reset.
- Installer Mode 3:TY : Type of Heating System.
- Installer Mode 4:Od : Outdoor Temp.
- Installer Mode 5.bS : Boost Timing.

■ Adjusting Outdoor Temperature Reset Control Options

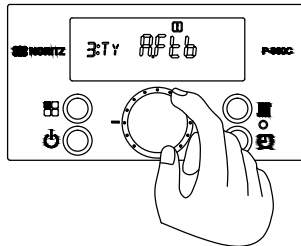

6. Turn the 'Dial Button' clockwise until '[3:TY]' is displayed on the screen.

■ Types of Heating Application (See below for how to select hot water heating source.)

Heating Application	Display	Set point Range(°F/°C)		Note
		Low	High	
Finned Tube Baseboard	A.Ftb	120°F (49°C)	180°F (82°C)	Default
Air Handler	b.AH	140°F (60°C)	180°F (82°C)	
Cast Iron Baseboard	C.Cib	100°F (38°C)	170°F (76.5°C)	
Low Mass Radiant Floor	d.LrF	80°F (26.5°C)	140°F (60°C)	
High Mass Radiant Floor	E. rF	80°F (26.5°C)	120°F (48°C)	
Radiator	F.rAd	120°F (49°C)	170°F (76.5°C)	
Custom Setting	G.CUS	100°F (38°C)	180°F (82°C)	Factory Set

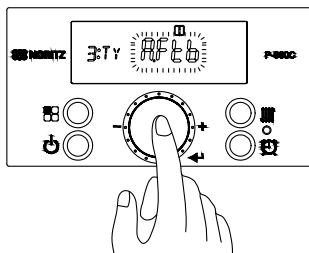

7. With '3:TY' displayed, press the 'Dial Button'. 'A:Ftb' will begin flashing (default). Turn the 'Dial Button' clockwise to select the appropriate heating system type. Press the 'Dial Button' to confirm the setting.

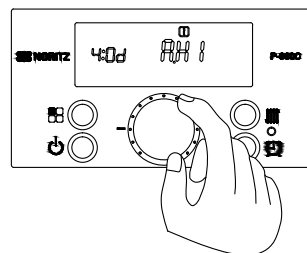

8. Turn the 'Dial Button' until '4:Od' is displayed. '4:Od' allows for adjustment of the design outdoor temperature range.

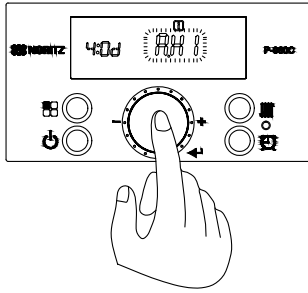

9. With '4:Od' displayed, press the 'Dial Button'. 'A:HI' will begin flashing.

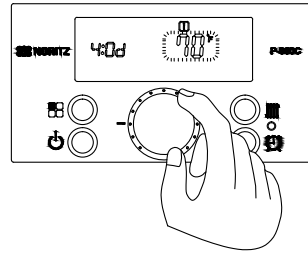

10. Press the 'Dial Button'. The default design warm weather temperature (70°F) will flash on the display. Turn the 'Dial Button' to adjust to the desired temperature.

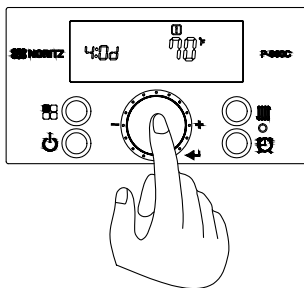

11. Press the 'Dial Button' to confirm the setting.

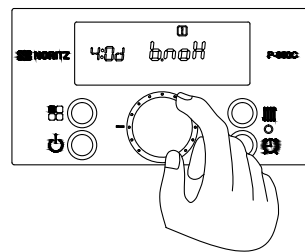

12. Turn the 'Dial Button' to 'b:NoH'.

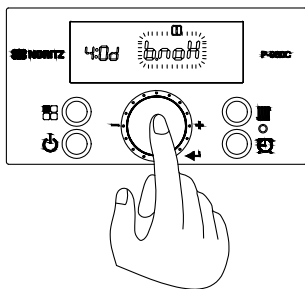

13. Press the 'Dial Button'. 'b:NoH' will begin to flash on the display.

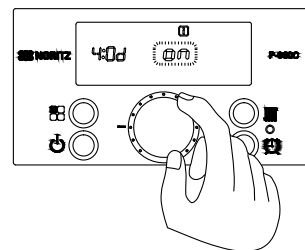

14. Press the 'Dial Button'. The default setting of ON will begin to flash on the display. Turn the 'Dial Button' to OFF if desired.

NOTE:

- b.noH : Toggles a fixed tolerance (+5°F) for the warm weather temperature setting of 'A:HI'.
- 'ON' : Combi Boiler will stop operation when the outdoor temperature reaches 'A:HI' setting +5°F.
- 'OFF': Combi Boiler will operate at the lowest heating set temperature when the outdoor temperature reaches 'A:HI' setting +5°F.

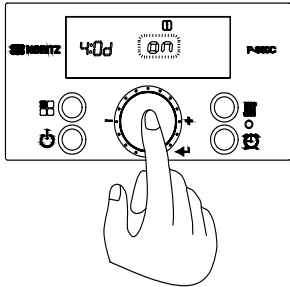

15. Press the 'Dial Button' to confirm the setting.

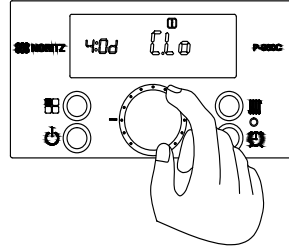

16. Turn the 'Dial Button' until 'C.Lo' is displayed. 'C.Lo' allows for adjustment of the design low temperature setting.

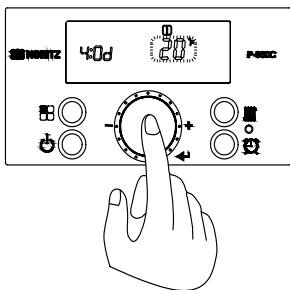

17. Press the 'Dial Button'. The default design cold weather temperature (20°F) will flash on the display. Turn the 'Dial Button' to adjust to the desired temperature.

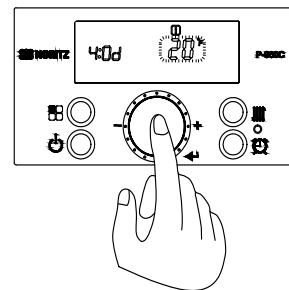

18. Press the 'Dial Button' to confirm the setting.

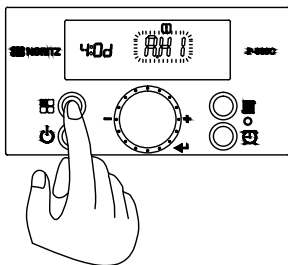

19. To return to the 'Installer Mode' main menu, press the 'Function Button'. Use the 'Dial Button' to scroll through the other menu options. To exit 'Installer Mode', press the 'Function Button' once more.

■ Outdoor Temperature Sensor Installation Guidelines

- Avoid areas with direct sunlight and where temperatures may not be representative of true outdoor temperature.
- Avoid placing sensor in close proximity of heat sources that may affect correct temperature sensing. (fans, exhausts, vents, lights)
- Avoid installing the sensor in areas where the sensor is subjected to excessive moisture.
- Make sure wiring connections are secure before closing the cap.
- The sensor is a water resistant device.
- Any damage to the device may require the replacement of the entire component.
- If the system requires a fixed operating temperature, the outdoor sensor is not required and should not be installed. There is no connection required if an outdoor sensor is not used in the installation.
- Use a minimum 22 AWG wire for runs of 100 feet or less and minimum 18 AWG wire for runs of up to 150 feet.
- Mount the outdoor sensor on an exterior surface of the building, preferably on the North or Northeast in an area that will not be affected by direct sunlight and will be exposed to varying weather conditions.
- For correct mounting procedures, follow instructions provided with the sensor.
- If sensor wires are located in an area with sources of potential electromagnetic interference (EMI), the sensor wires should be shielded, or the wires routed in a grounded metal conduit. If using shielded cable, the shielding should be connected to the common ground of the appliance.

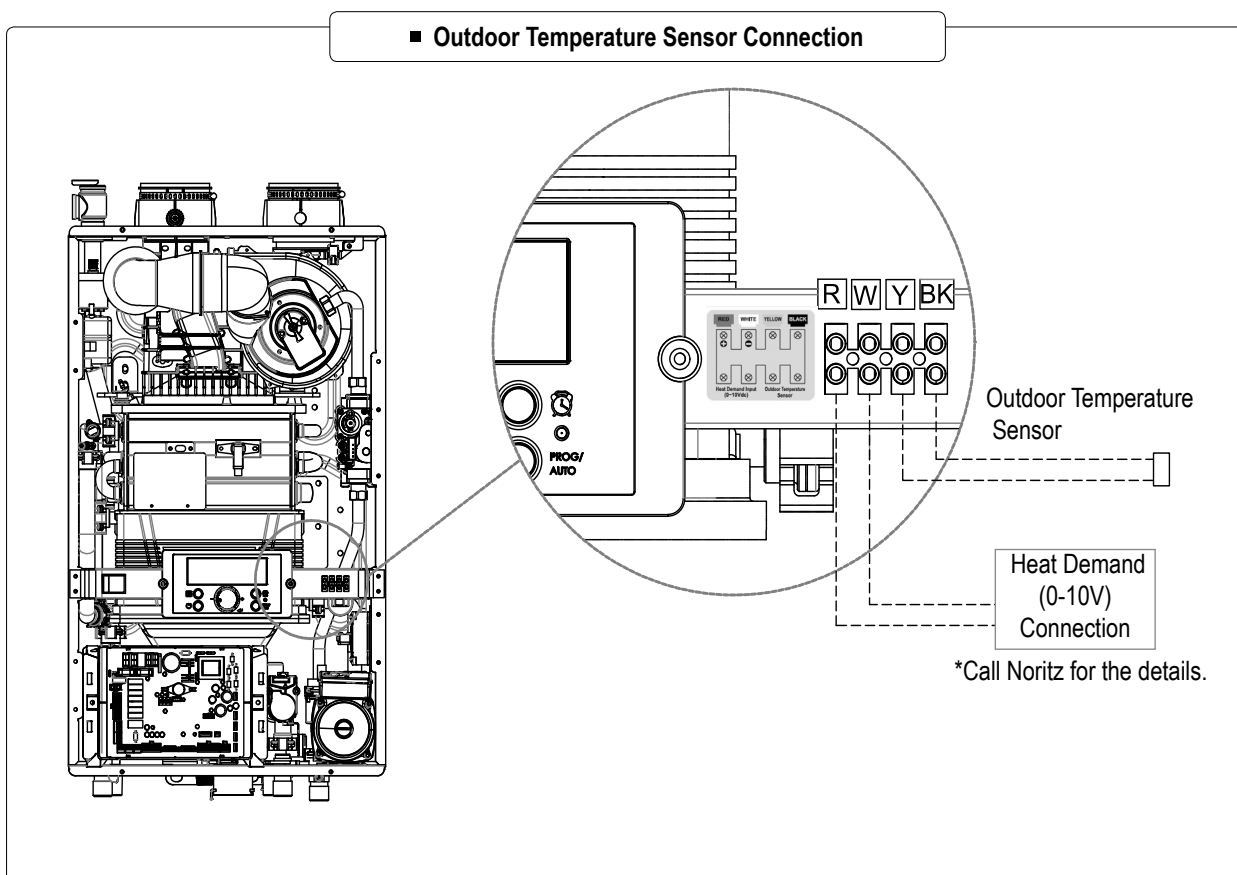



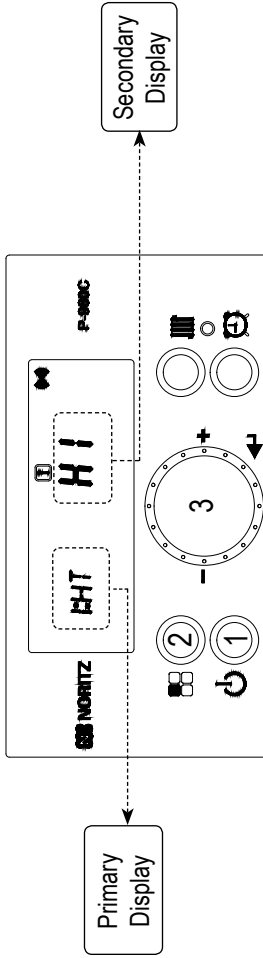



5-2. Installer Mode (Parameter Settings)



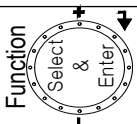
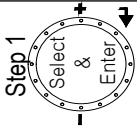
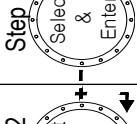
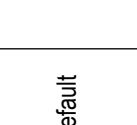
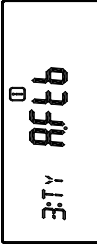
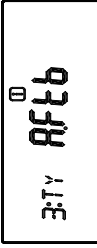

How to enter 'Installer Mode'

1. Turn off the power to the control panel.
2. Press and hold the 'Function Button' for approximately 5 seconds to get into the 'Installer Mode'.
3. Turn the 'Dial Button' clockwise or counter-clockwise to navigate to the desired function in the 'Installer Mode'. (Select)
4. Push 'Dial Button' to save setting. (Enter)

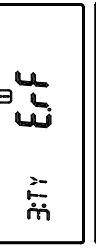
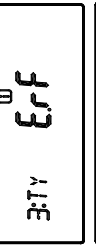
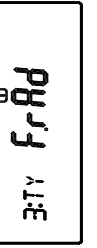
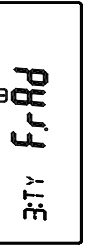
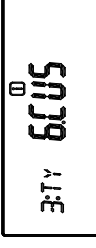

Function 	Primary Display		Secondary Display			Function Description	Reference Page(s)	
	Function Name	Heating Temp Range	Step 1	Step 2	Step 3			Default
1:HT	 	 	HI	121 - 180°F (49.5 - 82°C)		Default 180°F (82°C)	This setting is for changing the heating set temperature range. <ul style="list-style-type: none"> • You can change the Highest Set Temperature (HI) and the Lowest Set Temperature (Lo) by adjusting the numbers on the display. • If 2:TR (Outdoor Temperature Reset) is activated ('on') then the settings for 1:HT will be overridden by 2:TR settings. 	
2:TR	 	Outdoor Temp Reset 	oFF	80 - 120°F (26 - 49°C)		Default		

Primary Display		Secondary Display				Function Description	Reference Page(s)
Function 	Function Name	Step 1 	Step 2 	Step 3 	Default		
	Type of Heating System					<p>This section is used to select which type of Heating System is being used.</p> <ul style="list-style-type: none"> There are 6 typical Heating Systems that are available <ul style="list-style-type: none"> -Finned Tube Baseboard -Air Handler -Cast Iron Baseboard -Low Mass Radiant Floor -High Mass Radiant Floor -Radiator For these 6 heating types the low and high temperature points are pre-programmed. (See ranges to the left) <p>* If b.AH is selected, additional steps are needed to be programmed, see 8:AH below.</p>	Page 43
		A.Ftb	(Fin Tube Baseboard)		Default 120 - 180°F (49 - 82°C)		
		b.AH	(Air Handler)*		140 - 180°F (60 - 82°C)		
		C.Clb	(Cast Iron Baseboard)		100 - 170°F (38 - 76.5°C)		
		d.LrF	(Low Mass Radiant Floor)		80 - 140°F (26.5 - 60°C)		
		E.rF	(Mass Radiant Floor)		80 - 120°F (26.5 - 49°C)		
		F.rAd	(Radiator)		120 - 170°F (49 - 76.5°C)		
		G.CUS (Customized)	HI 121 - 180°F (49.5 - 82°C)	Lo 80 - 120°F (26.5 - 49°C)	Sub Default 180°F (82°C)	<ul style="list-style-type: none"> If you would like to use custom low and high temperature points, select G.CUS and follow the sub menus to set custom low and high temperature points. 	

Primary Display		Secondary Display				Function Description	Reference Page(s)
Function 	Function Name	Step 1 	Step 2 	Step 3 	Default		
	<u>Outdoor Temp</u>	A.HI	23 - 110°F (-5 - 43°C)		Default 70°F (21°C)	<p>The Combi Boiler will automatically use the Outdoor Temperature Settings and the Heating Application to adjust the set temperature of the unit for the most comfortable and economical heating temperature.</p> <ul style="list-style-type: none"> • A.HI (Outdoor High Temperature Setting) <p>This should be set at the highest average outdoor temperature in which the customer would like the heating system to continue to heat the home.</p> <ul style="list-style-type: none"> • b.noH (Warm Weather Shutdown Temperature Setting) - When 'on' the unit will go into energy saving mode and automatically stop heating when the outdoor temperature is 5°F (3°C) over the A.HI set point. - When 'oFF' the unit will continue to heat at the lowest temperature setting even if the outdoor temperature is greater than A.HI set point. • C.Lo (Outdoor Low Temperature Setting) <p>This should be set at the lowest average outdoor temperature during the winter season. (not the lowest possible outdoor temperature)</p> <ul style="list-style-type: none"> • When the Warm Weather Cutoff is on the icon will flash on the control panel. 	Pages 43- 45
4:Od (Skipped if 2:TR is oFF)	<div style="border: 1px solid black; padding: 2px; display: inline-block;">PC#4 AH I</div> <div style="border: 1px solid black; padding: 2px; display: inline-block;">PC#4 bnoH</div> <div style="border: 1px solid black; padding: 2px; display: inline-block;">PC#4 CLo</div>	b.noH	on	Default			
		C.Lo	-4 - 61°F (-20 - 16°C)		Default 20°F (-6.5°C)		
	<u>Boost Timing</u>	oFF			Default	<p>The setting is to increase the set temperature of the unit on cold start ups if the actual room temperature doesn't reach the thermostat set temperature quick enough, the Boost time function will increase the set temperature of the Combi Boiler 10°F (5.5°C) after the selected Boost time setting has passed.</p> <p>Example :</p> <p>Room thermostat set at 72°F, Combi Boiler set temp at 140°F and Boost time function set to 30 min. If the room temperature does not reach 72°F within 30 min then the Combi Boiler will increase it's set temp from 140°F to 150°F</p>	
5:bS (Skipped if 2:TR is oFF)	<div style="border: 1px solid black; padding: 2px; display: inline-block;">5:bS off</div> <div style="border: 1px solid black; padding: 2px; display: inline-block;">5:bS 12</div>	oFF	1 - 120 min				
	<u>Vent Material</u>	PVC			Default	<p>Vent Material function is used to limit the maximum exhaust temperature for the vent material used. For safety reasons the Combi Boiler operation will stop if the exhaust temperature exceeded maximum allowable temperature for the venting material.</p> <ul style="list-style-type: none"> • PVC maximum exhaust temperature is 149°F (65°C) • CPVC and PP maximum exhaust temperature is 200°F (93°C) 	Page 15
6:Vt	<div style="border: 1px solid black; padding: 2px; display: inline-block;">6:Vt PVC</div> <div style="border: 1px solid black; padding: 2px; display: inline-block;">6:Vt CPVC</div>	PVC					

Primary Display		Secondary Display				Function Description	Reference Page(s)										
Function	Function Name	Step 1	Step 2	Step 3	Default												
7:EL	High Elevation	0 - 2			Default	Select an altitude range from the following four options based on where the Combi Boiler is installed. <table border="1" style="margin-top: 10px;"> <thead> <tr> <th>7:EL setting</th> <th>Elevation above Sea Level</th> </tr> </thead> <tbody> <tr> <td>0 - 2</td> <td>0~1,999ft (0~609m)</td> </tr> <tr> <td>2 - 5</td> <td>2,000~4,999ft (610~1,523m)</td> </tr> <tr> <td>5 - 8</td> <td>5,000~7,999ft (1,524~2,438m)</td> </tr> <tr> <td>8 - 10</td> <td>8,000~10,000ft (2,439~3,048m)</td> </tr> </tbody> </table>	7:EL setting	Elevation above Sea Level	0 - 2	0~1,999ft (0~609m)	2 - 5	2,000~4,999ft (610~1,523m)	5 - 8	5,000~7,999ft (1,524~2,438m)	8 - 10	8,000~10,000ft (2,439~3,048m)	Page 21
	7:EL setting	Elevation above Sea Level															
	0 - 2	0~1,999ft (0~609m)															
	2 - 5	2,000~4,999ft (610~1,523m)															
	5 - 8	5,000~7,999ft (1,524~2,438m)															
8 - 10	8,000~10,000ft (2,439~3,048m)																
	0 - 2																
	2 - 5																
	5 - 8																
	8 - 10																
8:AH	Air Handler	off			Default	This function needs to be turned 'on' if an Air Handler is being used as a heating type. <ul style="list-style-type: none"> When heating side is running the fan and pump for the Air Handler will be on. If the DWH side is running the fan and pump for the Air Handler will be off. If this is not set to 'on' the Air Handler fan will be running with no hot supply water from the Combi Boiler and blow cold air into the home while the DHW side is running. When the Air Handle is operating, the  icon will display on the control panel. 	Pages 38-39										
		on															
9:PH	Pre-Heating	off			Default	This function is used to preheat the internal DHW plate heat exchanger during selected times set. <ul style="list-style-type: none"> After turning on this function the timer will need to be set. When Pre Heating function is activated the  icon will be displayed on the control panel. 	Pages 18 - 20 in Owner's Guide										
		on															

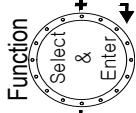
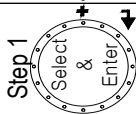
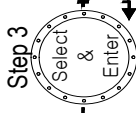
Primary Display		Secondary Display				Function Description	Reference Page(s)
Function 	Function Name	Step 1 	Step 2 	Step 3 	Default		
10:EP	External Pump 	off			Default	This setting can activate or deactivate the terminals in the Combi Boiler for an External Pump (secondary pump) on the circuit board. • When the External Pump is activated the icon will display on the control panel.	Page 36
11:WP	Water Pressure 	12 - 26 PSI			Default	This function is to control the water pressure on the heating side of the Combi Boiler. This will insure there is enough water inside the Combi Boiler to operate correctly. • The Auto Feeder will fill the system within 10 minutes. When the pressure of the system is over 2 PSI of Water Pressure Setting the Auto Feeder will close and water will stop filling the Combi Boiler. • Water Refilling Pressure: Set Valve - 4 PSI (0.002 BAR) • Water Refilling Stop Pressure: Set Valve + 2 PSI (0.001 BAR)	
12:IV	Interval 	0-20 min			Default 3 min	This function is to set up the Interval Time in Heating Mode to prevent inconsistency of heating • If the selected time passes and the Combi Boiler's inside temperature drops, this function will automatically reignite the burner in the Combi Boiler.	
13:Or	Pump Overrun Time 	HEAT	0 - 60 min		Default 20 min	This mode is to control how long the pump will run after the heating or DHW demand is satisfied. • This setting is to prevent unnecessary running of the pump and extend the life of the pump. • HEAT is used for the time after the heating system stops burning. • do.H is used for the time after the DHW system stops burning.	
		do.H	1 - 20 min		Default 3 min		

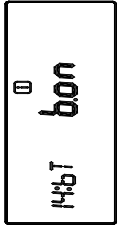
Primary Display		Secondary Display			Function Description	Reference Page(s)	
Function 	Function Name	Step 1 	Step 2 	Step 3 			Default
14:bT	Burner Set Temp  	A.off	0 - 30°F [0 - 16.5°C]		Default 10°F (5.5°C)	This mode is to set the activation points for the Heating Mode. <ul style="list-style-type: none"> • When the internal temperature of the Combi Boiler is to high or low the unit will stop burning or start burning. • Burner Stop Temperature = Heating Set Temperature + A.oFF • Burner Operating Temperature = Heating Set Temperature - b.on 	
		b.on	1 - 30°F [0.5 - 16.5°C]		Default 30°F (16.5°C)		

6-1. Final Check List

■ Final check : On the installation conditions.

- Is the Combi Boiler securely mounted on the wall?
- Is there space for a drain which is close to the Combi Boiler?
- Is there any combustible material near the Combi Boiler and vent pipe?
- Is the air supply sufficient for proper operation of the Combi Boiler?
- Are the proper service clearances maintained?
- Is the distance between the Combi Boiler and point of vent termination minimized?
- Are the proper space from windows, doors, and other intake vents maintained?

■ Final check : Gas pipe installation

- Is the gas supply line equipped with a manual shut off valve?
- Is the gas supply line a minimum of 3/4" inner diameter?
- Is the gas supply line length and diameter adequacy to deliver the required BTUs?
- Has the gas supply line pressure been measured?
- Does the gas type match with the type indicated on the rating plate?

■ Final check: Air / Vent pipe installation

- Has the Combi Boiler been vented with 2" or 3" PVC, CPVC, Polypropylene or BH Special Gas Vent (S636 PVC, CPVC) for Category IV appliances in accordance with this manual and/or your local code?
- Is the vent termination at least 12" above the exterior grade?
- Is the total vent length within the maximum vent length restriction?
- Have you checked the air/vent piping for leaks?
- Have you properly supported the vent termination?
- Are all vent runs properly supported?
- Is the vent sloped upward toward the vent termination at a rate of 1/4" per foot (2% grade)?

■ Final check : Condensate drain installation

- Have you installed a condensate drain line from the Combi Boiler to a drain or laundry tub?

■ Connecting the power supply

- Please check the power specifications. Is that AC 120V power?
- Have you checked the polarity of the electrical connection?

■ Final check : Pressure relief valve

- Have you installed an approved pressure relief valve on the Combi Boiler?
- Is the pressure relief valve of DHW Plumbing at least 3/4" in diameter?
- Have you installed the pressure relief valve on the DHW outlet pipe near the Combi Boiler?

■ Final check : Burner flames

- The burner flame must be checked periodically for a constant proper blue color.
- If the flame does not appear normal, the burner may need to be cleaned.
- If the burner needs to be cleaned, it must be performed by a qualified service technician.

6-2. Maintenance Periodically check the following to ensure proper operation of the Combi Boiler..

- The venting system must be examined periodically by a qualified service technician to check for any leaks or corrosion.
- The burner flame must be checked periodically for a proper blue color and consistency.
- If the flame does not appear normal, the burner may need to be cleaned.
- If the burner needs to be cleaned, it must be performed by a qualified service technician.
- Do not obstruct the flow of combustion and ventilation air.
- The pressure relief valve must be operated once a year to ensure that it is functioning properly and there is no obstruction. Turn the power off to the unit before opening the relief valve, and make sure that water draining out of the valve will not cause any damage.
- If the relief valve discharges periodically, it may be due to thermal expansion in a closed water system. Contact the water supplier or a local plumbing inspector on how to correct this situation. Do not plug the relief valve.
- See Operation Manual for further maintenance.

⚠ WARNING

There is a scald potential if the output temperature is set too high.

Should overheating occur, or the gas supply fail to shut off, turn off the manual gas control valve to the appliance.

Do not use this appliance if any part has been under water. Immediately call a qualified service technician to inspect the appliance and to replace any part of the control system and any gas control which has been under water.

Periodically check and clean the filter inside the DHW cold water inlet of the unit.

MAINTENANCE LOG

⚠ CAUTION

In unusually dirty or dusty conditions, care must be taken to keep Combi Boiler cabinet door in place at all times. Failure to do so VOIDS WARRANTY!

⚠ WARNING

Allowing the Combi Boiler to operate with a dirty combustion chamber will hurt operation. Failure to clean the heat exchanger as needed by the installation location could result in Combi Boiler failure, property damage, personal injury, or death. Such product failures ARE NOT covered under warranty.

The Combi Boiler requires minimal periodic maintenance under normal conditions. However, in unusually dirty or dusty conditions, periodic vacuuming of the cover to maintain visibility of the display and indicators is recommended. Periodic maintenance should be performed once a year by a qualified service technician to assure that all the equipment is operating safely and efficiently. The owner should make necessary arrangements with a qualified heating contractor for periodic maintenance of the Combi Boiler. Installer must also inform the owner that the lack of proper care and maintenance of the Combi Boiler may result in a hazardous condition.

INSPECTION ACTIVITIES		DATE LAST COMPLETED			
		1st YEAR	2nd YEAR	3rd YEAR	4th YEAR
Piping					
Near Combi Boiler piping	Check The Combi Boiler and system piping for any sign of leakage. Leaking pipes could cause property damage. Make sure all piping is properly supported. Flush DHW plate heat exchanger annually (more in hard water conditions). See Owner's Guide for instructions.				
Vent	Check condition of all vent pipes and joints. Ensure all vent piping is properly supported. Check for obstructions exhaust and intake termination points.				
Gas	Check Gas piping, test for leaks and signs of aging. Make sure all pipes are properly supported.				
SYSTEM					
Visual	Do a full visual inspection of all system components.				
Functional	Test all functions of the system (Heat, Safeties)				
ELECTRICAL					
Connections	Check wire connections. Make sure they are tight.				
Switch and Plug	Verify ON/OFF switch and convenience plug are both functional				
CONDENSATE					
Condensate Trap	Clean debris from the condensate trap. Fill with clean water.				
Neutralizer	Check condensate neutralizer. Replace if necessary.				
Condensate hose	Disconnect condensate hose. Clean out dirt and re-install. (NOTE: Verify the flow of condensate, making sure that the hose is properly connected during final inspection.)				
GAS					
Pressure	Measure incoming gas pressure (NG : 3.5" to 10.5" W.C.) (LP : 8.0" to 14" W.C.)				
Check gas pipe for leaks	Check piping for leaks. Verify that all are properly supported.				
COMBUSTION					
CO/CO2 Levels	Check CO and CO2 levels in Exhaust. Record at high and low fire.				

Installation Manual

Register your Warranty online at www.noritz.com/warranty



NORITZ AMERICA CO. 11160 Grace Avenue Fountain Valley, CA 92708
Phone : 866 - 766 - 7489