



COMFORT PEX

PEX TUBING • FITTINGS • ACCESSORIES

RA **RATHE**
ASSOCIATES

EXPECT MORE FROM RATHE ASSOCIATES.



This radiant catalog offers you a complete selection of everything you will need to complete your next radiant project. Tubing, fittings, manifolds and all accessories. Exactly what you'll need and more. But that's not all you can expect from Rathe Associates.

EXPECT BETTER SERVICE

From the moment you call, our customer service people will spend the time with you to help plan, design or troubleshoot your project. We're here to answer any questions you may have.



EXPECT EXPERT TECHNICAL ADVICE

With over 37 years of experience under our belts our in-house support team of experts can help you find a solution to the most demanding applications, provide technical backup, and field support.

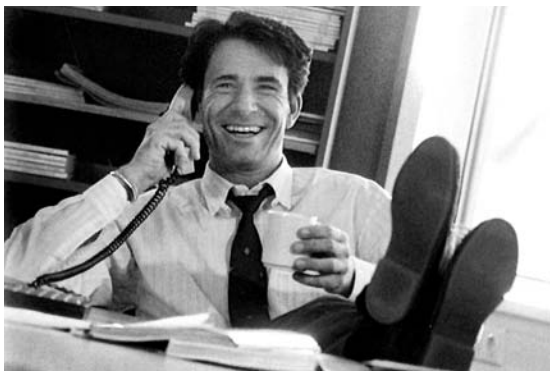

EXPECT PROJECT DESIGN ASSISTANCE

Let us help you design any project. Whatever you need, from the small projects like bathrooms and kitchens, to the mega-mansions, commercial buildings and snow melting applications. We'll gladly supply custom drawings of your radiant tubing layouts, electrical diagrams, and boiler piping details. We'll even stand side-by-side with you and your team at the jobsite.



Expect More from Rathe Associates & Get It.

1650 New Highway, Farmingdale, NY 11735

631.822.1200

fax 631.822.1400 • www.ratheassoc.com



TABLE OF CONTENTS

Section 1 - PEX Tubing - Heating & PlumbingPg. 5

Nomenclature	Nomenclature Description
H	Oxygen Barrier HEAT PEX Tubing
P	Non-Oxygen Barrier Plumb PEX Tubing
38	3/8" Tubing Size
12	1/2" Tubing Size
58	5/8" Tubing Size
34	3/4" Tubing Size
1	1" Tubing Size
20; 100; 150; 250; 300; 400; 450; 500; 600; 1000	Tubing Length - Straight Length (20' Only) and Coil Length
R; B; W	Red; Blue or White - Tubing Color

Section 2 - Crimp (Barbed) PEX FittingsPg. 6-9

Nomenclature	Nomenclature Description
CR	Crimp (Barbed) Style Fitting
38	3/8" Tubing Size
12	1/2" Tubing Size
58	5/8" Tubing Size
34	3/4" Tubing Size
1	1" Tubing Size
CPL	Coupling (Union) Fitting
L	90° Elbow Fitting
T	Tee Fitting
MS	Male Sweat Fitting
FS	Female Sweat Fitting
MPT	Male Pipe Threaded Fitting
MPTL	Male Pipe Threaded 90° Elbow Fitting
FPT	Female Pipe Thread Fitting
FPTS	Female Pipe Thread Swivel Fitting
DRPL	Drop-Elbow Fitting
PLG	Plug Fitting
BV	Ball Valve
ASV	Angle-Stop Valve
SSV	Straight-Stop Valve
BM	Mini-Block Manifold
CM	Copper Manifold - 'Spun' type
I; IO	Inlet Only or Inlet/Outlet options on Copper 'Spun' Manifolds
SO; SOL; SOTB; SOTL	'Stub-Out' - Elbow; 'Stub-Out' Tee w/ Bracket or 'Stub-Out' Tee & Elbow
RINGTL	Crimping Tool
REMTL	Crimp Removal Tool

Section 3 - Compression PEX FittingsPg. 10

Nomenclature	Nomenclature Description
CO	Compression Style Fitting
38	3/8" Tubing Size
12	1/2" Tubing Size
58	5/8" Tubing Size
34	3/4" Tubing Size
1	1" Tubing Size
CPL	Coupling (Union) Fitting
MS	Male Sweat Fitting
FS	Female Sweat Fitting
FSL	Female Sweat 90° Elbow Fitting
MPT	Male Pipe Threaded Fitting

TABLE OF CONTENTS

Section 4 - Radiant ManifoldsPg. 11-14

Nomenclature	Nomenclature Description	Nomenclature	Nomenclature Description
MC	Copper Manifold Type	AV	Air Vent
MS	Stainless Steel Manifold Type	MBSET	Mounting bracket
MP	Plastic Modular HydroLock Manifold Type	SKIT	Starter Kit
(2-12)L	# of Loops	SUP	Supply
38	3/8" Tubing Size	RET	Return
12	1/2" Tubing Size	LKR; LKB	Locking Key - Red or Blue
58	5/8" Tubing Size	MCON	Manifold Connector - Stainless Steel or Plastic Manifolds Only
34	3/4" Tubing Size	CAP	Manifold Cap - Stainless Steel or Plastic Manifolds Only
CR	Crimp (Barbed) Style Copper Manifold Type	AV	Air Vent
BV	Ball Valve - for Copper Manifolds	ZV	Zone Valve
ENDTAP	Endcap with Tappings	MPS	Plastic & Stainless Steel Manifold Type
END	Plain End Cap		
PV	Purge Valve		

Section 5 - AccessoriesPg. 15-16

Nomenclature	Nomenclature Description	Nomenclature	Nomenclature Description
38	3/8" Tubing Size	QCB	Quick-Clip
12	1/2" Tubing Size	WT	Wire-Tie
58	5/8" Tubing Size	MBS	Metal Bend Support
34	3/4" Tubing Size	PL	Plastic Sleeve (H) or Conduit
TU	Tubing Uncoiler	PT	Pipe Tracking
TC; TCB	Tubing Cutter / Replacement Blades	HTP	Heat Transfer Plate
SGH; SGHP	Staple Gun - Hand / Pneumatic Hand	RT#S; RT#SBX	Radiant Track - Side mounted (per piece or box of 20)
SG38; SG12;	Staples for Hand Gun;	PB	OnePanel - Radiant Panel
SG58; SG34	3/8", 1/2", 5/8" or 3/4" tubing size	PBV	Pressure Balancing Valve
PC	Plastic Clamp (Strap)	TG	Temperature Gauge
SC	Suspension Clamp (Strap)		
UN	U-Nail		

Section 6 - Miscellaneous - APg. 17

Nomenclature	Nomenclature Description
LCM	Large Copper Manifold - 6' Length
1; 125; 150; 2	Large Copper Manifold Pipe Size - 1", 1-1/4", 1-1/2" or 2"
12; 34	Outlet Pipe Size - 1/2" or 3/4"
12; 18; 24	Outlet Quantity - 12 outlet/6" c-c; 18 outlet/4" c-c; 24 outlet/3" c-c
C; CBV	Crimp (barbed) fitting; Crimp (barbed) fitting with Ball Valve
BV34B; BV34R	Ball Valve - 3/4" Red or Blue Handle
MC#LCBV	Small Copper Manifold with Crimp (barbed) fitting and Ball Valve

Section 7 - Miscellaneous - B.....Pg. 18-19

Nomenclature	Nomenclature Description
IT	Insul-Tarp Insulation
16; 4; 6; 12	Insul-Tarp WIDTH dimension - 16", 4', 6' or 12'
25; 50; 125	Insul-Tarp LENGTH dimension - 25', 50', 125'
FBF; FBP	Layering on insulation - Foil-Bubble-Foil or Foil-Bubble-Poly
AX#L; AX#HP	Axiom Units - size, Large 'L' or High-Pressure 'HP'
HX#; HX#LPD	Heat Exchanger - BTU rating and Low-Pressure-Drop (LPD)

Some products listed in this publication may vary from illustrations shown.

PEX TUBING

Oxygen Barrier Tubing - Heating

Part No.	Product Description	Box Qty
H38150	3/8" PEX x 150' Coil Oxygen Barrier Heat Pex Tubing	1
H38300	3/8" PEX x 300' Coil Oxygen Barrier Heat Pex Tubing	1
H38600	3/8" PEX x 600' Coil Oxygen Barrier Heat Pex Tubing	1
H381000	3/8" PEX x 1000' Coil Oxygen Barrier Heat Pex Tubing	1
H12300	1/2" PEX x 300' Coil Oxygen Barrier Heat Pex Tubing	1
H12600	1/2" PEX x 600' Coil Oxygen Barrier Heat Pex Tubing	1
H121000	1/2" PEX x 1000' Coil Oxygen Barrier Heat Pex Tubing	1
H58400	5/8" PEX x 400' Coil Oxygen Barrier Heat Pex Tubing	1
H58450	5/8" PEX x 450' Coil Oxygen Barrier Heat Pex Tubing	1
H581000	5/8" PEX x 1000' Coil Oxygen Barrier Heat Pex Tubing	1
H34250	3/4" PEX x 250' Coil Oxygen Barrier Heat Pex Tubing	1
H34300	3/4" PEX x 300' Coil Oxygen Barrier Heat Pex Tubing	1
H34500	3/4" PEX x 500' Coil Oxygen Barrier Heat Pex Tubing	1
H341000	3/4" PEX x 1000' Coil Oxygen Barrier Heat Pex Tubing	1
H1100	1" PEX x 100' Coil Oxygen Barrier Heat Pex Tubing	1
H1150	1" PEX x 150' Coil Oxygen Barrier Heat Pex Tubing	1
H1500	1" PEX x 500' Coil Oxygen Barrier Heat Pex Tubing	1

Straight Lengths - Heating

Part No.	Product Description	Box Qty
H1220	1/2" PEX x 20' Length Oxygen Barrier Heat Pex Tubing	25
H3420	3/4" PEX x 20' Length Oxygen Barrier Heat Pex Tubing	10
H120	1" PEX x 20' Length Oxygen Barrier Heat Pex Tubing	5

Technical Data

Pipe Size (I.D.)	3/8"	1/2"	5/8"	3/4"	1"
Actual O.D.	.500	.625	.750	.875	1.125
Actual I.D.	.360	.475	.584	.670	.875
Water Content (USG/100ft.)	.491	.920	1.387	1.89	3.12
Temperature & Pressure	180°F at 100 PSI, 73.4°F at 160 PSI, 200°F at 80 PSI				
Oxygen Diffusion	< .10g/cubic meter/day (DIN 4726)				
Pex Pipe Material	High Density Polyethylene				
Oxygen Barrier Material	Ethylene Vinyl Alcohol (EVOH)				



Pex Tubing (cross-linked polyethylene) is for hot and cold potable water distribution systems and may be used in heating systems that provide tubing isolation from ferrous system components. Pex Tubing is manufactured to ASTM F876 and F877 and is listed to NSF Standards 14 and 61.

Non-Oxygen Barrier Tubing - Potable Water Only

Part No.	Product Description	Box Qty
P12100R	1/2" PEX x 100' Coil RED Non-Oxygen Barrier Plumb Pex Tubing	1
P12100B	1/2" PEX x 100' Coil BLUE Non-Oxygen Barrier Plumb Pex Tubing	1
P12100W	1/2" PEX x 100' Coil WHITE Non-Oxygen Barrier Plumb Pex Tubing	1
P34100R	3/4" PEX x 100' Coil RED Non-Oxygen Barrier Plumb Pex Tubing	1
P34100B	3/4" PEX x 100' Coil BLUE Non-Oxygen Barrier Plumb Pex Tubing	1
P34100W	3/4" PEX x 100' Coil WHITE Non-Oxygen Barrier Plumb Pex Tubing	1
P1100W	1" PEX x 100' Coil WHITE Non-Oxygen Barrier Plumb Pex Tubing	1
P12250R	1/2" PEX x 250' Coil RED Non-Oxygen Barrier Plumb Pex Tubing	1
P12250B	1/2" PEX x 250' Coil BLUE Non-Oxygen Barrier Plumb Pex Tubing	1
P12250W	1/2" PEX x 250' Coil WHITE Non-Oxygen Barrier Plumb Pex Tubing	1
P34250R	3/4" PEX x 250' Coil RED Non-Oxygen Barrier Plumb Pex Tubing	1
P34250B	3/4" PEX x 250' Coil BLUE Non-Oxygen Barrier Plumb Pex Tubing	1
P34250W	3/4" PEX x 250' Coil WHITE Non-Oxygen Barrier Plumb Pex Tubing	1
P12300R	1/2" PEX x 300' Coil RED Non-Oxygen Barrier Plumb Pex Tubing	1
P12300B	1/2" PEX x 300' Coil BLUE Non-Oxygen Barrier Plumb Pex Tubing	1
P12300W	1/2" PEX x 300' Coil WHITE Non-Oxygen Barrier Plumb Pex Tubing	1
P34300R	3/4" PEX x 300' Coil RED Non-Oxygen Barrier Plumb Pex Tubing	1
P34300B	3/4" PEX x 300' Coil BLUE Non-Oxygen Barrier Plumb Pex Tubing	1
P34300W	3/4" PEX x 300' Coil WHITE Non-Oxygen Barrier Plumb Pex Tubing	1

Straight Lengths - Potable Water Only

Part No.	Product Description	Box Qty
P1220R	1/2" PEX x 20' Length RED Non-Oxygen Barrier Plumb Pex Tubing	25
P1220B	1/2" PEX x 20' Length BLUE Non-Oxygen Barrier Plumb Pex Tubing	25
P1220W	1/2" PEX x 20' Length WHITE Non-Oxygen Barrier Plumb Pex Tubing	25
P3420R	3/4" PEX x 20' Length RED Non-Oxygen Barrier Plumb Pex Tubing	10
P3420B	3/4" PEX x 20' Length BLUE Non-Oxygen Barrier Plumb Pex Tubing	10
P3420W	3/4" PEX x 20' Length WHITE Non-Oxygen Barrier Plumb Pex Tubing	10
P120W	1" PEX x 20' Length WHITE Non-Oxygen Barrier Plumb Pex Tubing	5

CRIMP (BARBED) PEX FITTINGS

Couplings [Unions]

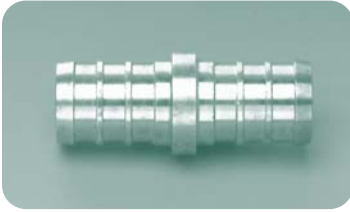

Part No.	Product Description	Bag Qty
CR38CPL	3/8" PEX Crimp Coupling	50
CR12CPL	1/2" PEX Crimp Coupling	25
CR58CPL	5/8" PEX Crimp Coupling	25
CR34CPL	3/4" PEX Crimp Coupling	25
CR1CPL	1" PEX Crimp Coupling	50
CR1238CPL	1/2" PEX Crimp x 3/8" PEX Crimp Coupling	50
CR3412CPL	3/4" PEX Crimp x 1/2" PEX Crimp Coupling	50
CR134CPL	1" PEX Crimp x 3/4" PEX Crimp Coupling	50



90° Elbows

Part No.	Product Description	Bag Qty
CR38L	3/8" PEX Crimp 90° Elbow	100
CR12L	1/2" PEX Crimp 90° Elbow	50
CR58L	5/8" PEX Crimp 90° Elbow	25
CR34L	3/4" PEX Crimp 90° Elbow	50
CR3412L	3/4" PEX Crimp x 1/2" PEX Crimp 90° Elbow	50
CR1L	1" PEX Crimp 90° Elbow	25



Tees [Run x Run x Bull]

Part No.	Product Description	Bag Qty
CR38T	3/8" PEX Crimp Tee	100
CR12T	1/2" PEX Crimp Tee	50
CR58T	5/8" PEX Crimp Tee	25
CR34T	3/4" PEX Crimp Tee	25
CR1T	1" PEX Crimp Tee	25
CR123838T	1/2" x 3/8" x 3/8" PEX Crimp Tee	50
CR121234T	1/2" x 1/2" x 3/4" PEX Crimp Tee	25
CR341212T	3/4" x 1/2" x 1/2" PEX Crimp Tee	25
CR341234T	3/4" x 1/2" x 3/4" PEX Crimp Tee	25
CR343412T	3/4" x 3/4" x 1/2" PEX Crimp Tee	25
CR13434T	1" x 3/4" x 3/4" PEX Crimp Tee	25
CR1112T	1" x 1" x 1/2" PEX Crimp Tee	25
CR1134T	1" x 1" x 3/4" PEX Crimp Tee	25
CR383812MPT	3/8" PEX Crimp x 3/8" PEX Crimp x 1/2" MPT Tee	25
CR121212MPT	1/2" PEX Crimp x 1/2" PEX Crimp x 1/2" MPT Tee	25



MS FS

Male Sweat Adapters

Part No.	Product Description	Bag Qty
CR3812MS	3/8" PEX Crimp x 1/2" Male Sweat Adapter	50
CR1212MS	1/2" PEX Crimp x 1/2" Male Sweat Adapter	50
CR1234MS	1/2" PEX Crimp x 3/4" Male Sweat Adapter	25
CR5834MS	5/8" PEX Crimp x 3/4" Male Sweat Adapter	25
CR3434MS	3/4" PEX Crimp x 3/4" Male Sweat Adapter	50
CR11MS	1" PEX Crimp x 1" Male Sweat Adapter	25



MS FS

Female Sweat Adapters

Part No.	Product Description	Bag Qty
CR3812FS	3/8" PEX Crimp x 1/2" Female Sweat Adapter	25
CR1212FS	1/2" PEX Crimp x 1/2" Female Sweat Adapter	50
CR1234FS	1/2" PEX Crimp x 3/4" Female Sweat Adapter	25
CR5834FS	5/8" PEX Crimp x 3/4" Female Sweat Adapter	25
CR3434FS	3/4" PEX Crimp x 3/4" Female Sweat Adapter	50
CR11FS	1" PEX Crimp x 1" Female Sweat Adapter	25

CRIMP (BARBED) PEX FITTINGS

Male Sweat 90° Elbows

Part No.	Product Description	Bag Qty
CR1234MSL	1/2" PEX Crimp x 3/4" Male Sweat 90° Elbow	25
CR5834MSL	5/8" PEX Crimp x 3/4" Male Sweat 90° Elbow	25
CR3434MSL	3/4" PEX Crimp x 3/4" Male Sweat 90° Elbow	25



Female Sweat 90° Elbows

Part No.	Product Description	Bag Qty
CR1234FSL	1/2" PEX Crimp x 3/4" Female Sweat 90° Elbow	25
CR5834FSL	5/8" PEX Crimp x 3/4" Female Sweat 90° Elbow	25
CR3434FSL	3/4" PEX Crimp x 3/4" Female Sweat 90° Elbow	25



MPT Adapters [Male Pipe Thread]

Part No.	Product Description	Bag Qty
CR3812MPT	3/8" PEX Crimp x 1/2" MPT Adapter	50
CR1212MPT	1/2" PEX Crimp x 1/2" MPT Adapter	50
CR1234MPT	1/2" PEX Crimp x 3/4" MPT Adapter	50
CR3412MPT	3/4" PEX Crimp x 1/2" MPT Adapter	50
CR3434MPT	3/4" PEX Crimp x 3/4" MPT Adapter	50
CR134MPT	1" PEX Crimp x 3/4" MPT Adapter	25
CR11MPT	1" PEX Crimp x 1" MPT Adapter	25



FPT Adapters [Female Pipe Thread]

Part No.	Product Description	Bag Qty
CR3812FPT	3/8" PEX Crimp x 1/2" FPT Adapter	50
CR1212FPT	1/2" PEX Crimp x 1/2" FPT Adapter	50
CR1234FPT	1/2" PEX Crimp x 3/4" FPT Adapter	50
CR3434FPT	3/4" PEX Crimp x 3/4" FPT Adapter	25
CR11FPT	1" PEX Crimp x 1" FPT Adapter	25



FPT Swivel Adapters [Female Pipe Thread]

Part No.	Product Description	Bag Qty
CR3812FPTS	3/8" PEX Crimp x 1/2" FPT Swivel Adapter	1
CR1212FPTS	1/2" PEX Crimp x 1/2" FPT Swivel Adapter	1
CR3434FPTS	3/4" PEX Crimp x 3/4" FPT Swivel Adapter	1



MPT 90° Elbows [Male Pipe Thread]

Part No.	Product Description	Bag Qty
CR3812MPTL	3/8" PEX Crimp x 1/2" MPT 90° Elbow	25
CR1238MPTL	1/2" PEX Crimp x 3/8" MPT 90° Elbow	25
CR1212MPTL	1/2" PEX Crimp x 1/2" MPT 90° Elbow	25
CR1234MPTL	1/2" PEX Crimp x 3/4" MPT 90° Elbow	10
CR3434MPTL	3/4" PEX Crimp x 3/4" MPT 90° Elbow	10



FPT 90° Elbows [Female Pipe Thread] - Unavailable at this time
(May use 'Drop-Ear' Elbow as alternative)

Drop-Ear 90° Elbow

Part No.	Product Description	Bag Qty
CR1212DRPL	1/2" PEX Crimp x 1/2" FPT 90° Drop-Ear Elbow	10
CD3434DRPL	3/4" PEX Crimp x 3/4" FPT 90° Drop-Ear Elbow	10



CRIMP (BARBED) PEX FITTINGS



Test Plugs

Part No.	Product Description	Bag Qty
CR38PLG	3/8" Crimp Test Plug	100
CR12PLG	1/2" Crimp Test Plug	100
CR34PLG	3/4" Crimp Test Plug	100
CR1PLG	1" Crimp Test Plug	100



Shut-Off Valves

Part No.	Product Description	Bag Qty
CR1212FSBV	1/2" PEX Crimp x 1/2" Female Sweat Ball Valve	1
CR1212BV	1/2" PEX Crimp x 1/2" PEX Crimp Ball Valve	1
CR3434BV	3/4" PEX Crimp x 3/4" PEX Crimp Ball Valve	1
CR1238ASV	1/2" PEX Crimp x 3/8" O.D. Comp. Chrome Angle Stop Valve	1
CR1238SSV	1/2" PEX Crimp x 3/8" O.D. Comp. Chrome Straight Stop Valve	1

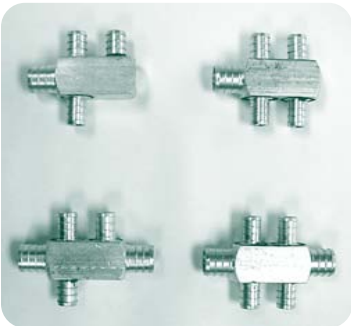

Mini-Block Manifolds

Part No.	Product Description	Bag Qty
CR1234BM3I	3-Branch 1/2" PEX Crimp x 3/4" PEX Crimp Inlet Only	1
CR1234BM3IO	3-Branch 1/2" PEX Crimp x 3/4" PEX Crimp Inlet/Outlet	1
CR1234BM4I	4-Branch 1/2" PEX Crimp x 3/4" PEX Crimp Inlet Only	1
CR1234BM4IO	4-Branch 1/2" PEX Crimp x 3/4" PEX Crimp Inlet/Outlet	1

Copper Manifolds [**Spun Closed Outlet]

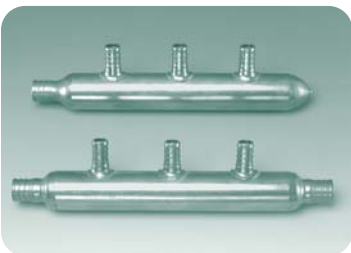

Part No.	Product Description	Bag Qty
CR1234CM3I	3-Branch 1/2" PEX Crimp x 3/4" PEX Crimp Inlet Only**	25/box
CR1234CM3IO	3-Branch 1/2" PEX Crimp x 3/4" PEX Crimp Inlet/Outlet	25/box
CR1234CM4I	4-Branch 1/2" PEX Crimp x 3/4" PEX Crimp Inlet Only**	25/box
CR1234CM4IO	4-Branch 1/2" PEX Crimp x 3/4" PEX Crimp Inlet/Outlet	25/box
CR1234CM5I	5-Branch 1/2" PEX Crimp x 3/4" PEX Crimp Inlet Only**	25/box
CR1234CM5IO	5-Branch 1/2" PEX Crimp x 3/4" PEX Crimp Inlet/Outlet	25/box
CR1234CM6I	6-Branch 1/2" PEX Crimp x 3/4" PEX Crimp Inlet Only**	25/box
CR1234CM6IO	6-Branch 1/2" PEX Crimp x 3/4" PEX Crimp Inlet/Outlet	25/box
CR1234CM8I	8-Branch 1/2" PEX Crimp x 3/4" PEX Crimp Inlet Only**	25/box
CR1234CM8IO	8-Branch 1/2" PEX Crimp x 3/4" PEX Crimp Inlet/Outlet	25/box

CRIMP (BARBED) PEX FITTINGS

Stub-Outs [Copper]

Part No.	Product Description	Bag Qty
CR12SO	1/2" PEX Crimp x 1/2" Nom., Spun Closed Straight - 12"	1
CR12SOL	1/2" PEX Crimp x 1/2" Nom., Spun Closed Elbow 3-1/2" x 8"	1
CR12SOTB	1/2" PEX Crimp x 1/2" Nom., Spun Closed Elbow w/ Sqr Mounting Bracket - 3-1/2" x 6"	1
CR12SOTL	1/2" PEX Crimp x 1/2" Nom., Spun Closed Tee / Elbow - 3" x 6"	1



Stainless Steel Clamps & Tools

Part No.	Product Description	Bag Qty
CR38CLAMP	3/8" Stainless Steel Clamp	100
CR12CLAMP	1/2" Stainless Steel Clamp	100
CR58CLAMP	5/8" Stainless Steel Clamp	50
CR34CLAMP	3/4" Stainless Steel Clamp	50
CR1CLAMP	1" Stainless Steel Clamp	50
CRRATCHET	Ratchet Tool for Stainless Steel Clamps	1
CRPINCER	Clamp Removal Pincer	1



Copper Crimp Rings & Tools

Part No.	Product Description	Bag Qty
CR38RING	3/8" Copper Crimp Ring	100
CR12RING	1/2" Copper Crimp Ring	100
CR58RING	5/8" Copper Crimp Ring	50
CR34RING	3/4" Copper Crimp Ring	100
CR1RING	1" Copper Crimp Ring	25
CR38RINGTL	3/8" Crimping Tool for Copper Crimp Rings	1
CR12RINGTL	1/2" Crimping Tool for Copper Crimp Rings	1
CR58RINGTL	5/8" Crimping Tool for Copper Crimp Rings	1
CR34RINGTL	3/4" Crimping Tool for Copper Crimp Rings	1
CR1RINGTL	1" Crimping Tool for Copper Crimp Rings	1
CR12REMTL	Removal Tool for 1/2" Copper Crimp Rings	1
CR34REMTL	Removal Tool for 3/4" Copper Crimp Rings	1
CRREMTL	Removal Tool for 1/2", 5/8", 3/4" & 1" Copper Crimp	1



CRRATCHET



CRPINCER

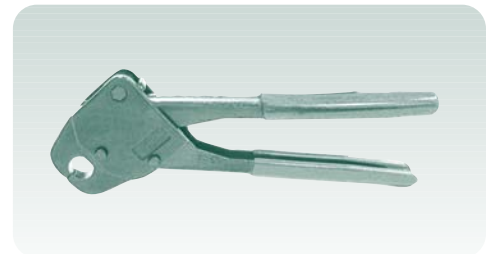

CR12RINGTL

COMPRESSION PEX FITTINGS

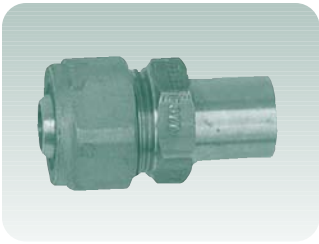

Male Sweat Adapters

Part No.	Product Description	Bag Qty
CO1212MS	1/2" PEX Comp. x 1/2" Male Sweat Adapter	25
CO5834MS	5/8" PEX Comp. x 3/4" Male Sweat Adapter	25
CO3434MS	3/4" PEX Comp. x 3/4" Male Sweat Adapter	25



Female Sweat Adapters

Part No.	Product Description	Bag Qty
CO3812FS	3/8" PEX Comp. x 1/2" Female Sweat Adapter	10
CO3834FS	3/8" PEX Comp. x 3/4" Female Sweat Adapter	10
CO1212FS	1/2" PEX Comp. x 1/2" Female Sweat Adapter	25
CO1234FS	1/2" PEX Comp. x 3/4" Female Sweat Adapter	10
CO5834FS	5/8" PEX Comp. x 3/4" Female Sweat Adapter	10
CO3434FS	3/4" PEX Comp. x 3/4" Female Sweat Adapter	10



Female Sweat 90° Elbows

Part No.	Product Description	Bag Qty
CO1212FSL	1/2" PEX Comp. x 1/2" Female Sweat 90° Elbow	25
CO1234FSL	1/2" PEX Comp. x 3/4" Female Sweat 90° Elbow	25
CO5834FSL	5/8" PEX Comp. x 3/4" Female Sweat 90° Elbow	25
CO3434FSL	3/4" PEX Comp. x 3/4" Female Sweat 90° Elbow	10

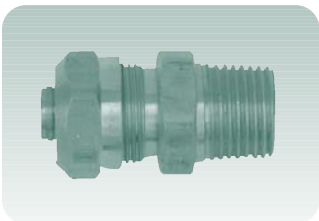

MPT Adapters [Male Pipe Thread]

Part No.	Product Description	Bag Qty
CO3812MPT	3/8" PEX Comp. x 1/2" MPT Adapter	25
CO1212MPT	1/2" PEX Comp. x 1/2" MPT Adapter	25
CO5834MPT	5/8" PEX Comp. x 3/4" MPT Adapter	25
CO3434MPT	3/4" PEX Comp. x 3/4" MPT Adapter	25
CO11MPT	1" PEX Comp. x 1" MPT Adapter	25

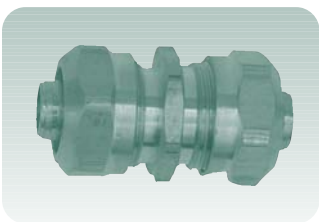

Couplings (Unions)

Part No.	Product Description	Bag Qty
CO38CPL	3/8" PEX Comp. Coupling	25
CO12CPL	1/2" PEX Comp. Coupling	10
CO58CPL	5/8" PEX Comp. Coupling	10
CO34CPL	3/4" PEX Comp. Coupling	10
CO1CPL	1" PEX Comp. Coupling	25

RADIANT MANIFOLDS

Copper Supply/Return Manifold Kits - Complete [PEX Compression Adapters]

Kit includes: Supply header with shut-off valves, Return header, PEX to MPT compression adapters, End caps, purge valve, auto air vent, mounting clips and metal bend supports.

Part No.	Product Description	Box Qty
MC2L38	2-Loop x 3/8" PEX Compression - Copper Manifold	1
MC3L38	3-Loop x 3/8" PEX Compression - Copper Manifold	1
MC4L38	4-Loop x 3/8" PEX Compression - Copper Manifold	1
MC5L38	5-Loop x 3/8" PEX Compression - Copper Manifold	1
MC6L38	6-Loop x 3/8" PEX Compression - Copper Manifold	1
MC7L38	7-Loop x 3/8" PEX Compression - Copper Manifold	1
MC8L38	8-Loop x 3/8" PEX Compression - Copper Manifold	1
MC9L38	9-Loop x 3/8" PEX Compression - Copper Manifold	1
MC10L38	10-Loop x 3/8" PEX Compression - Copper Manifold	1
MC11L38	11-Loop x 3/8" PEX Compression - Copper Manifold	1
MC12L38	12-Loop x 3/8" PEX Compression - Copper Manifold	1
MC2L12	2-Loop x 1/2" PEX Compression - Copper Manifold	1
MC3L12	3-Loop x 1/2" PEX Compression - Copper Manifold	1
MC4L12	4-Loop x 1/2" PEX Compression - Copper Manifold	1
MC5L12	5-Loop x 1/2" PEX Compression - Copper Manifold	1
MC6L12	6-Loop x 1/2" PEX Compression - Copper Manifold	1
MC7L12	7-Loop x 1/2" PEX Compression - Copper Manifold	1
MC8L12	8-Loop x 1/2" PEX Compression - Copper Manifold	1
MC9L12	9-Loop x 1/2" PEX Compression - Copper Manifold	1
MC10L12	10-Loop x 1/2" PEX Compression - Copper Manifold	1
MC11L12	11-Loop x 1/2" PEX Compression - Copper Manifold	1
MC12L12	12-Loop x 1/2" PEX Compression - Copper Manifold	1

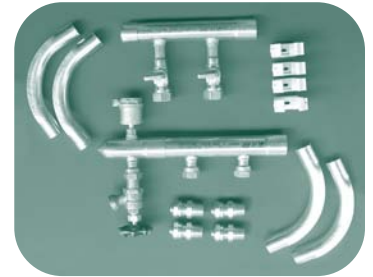

Copper Supply/Return Manifold Kits - Complete [PEX Crimp (Barbed) Adapters]

Kit includes: Supply header with shut-off valves, Return header, PEX to MPT crimp adapters, End caps, purge valve, auto air vent, mounting clips and metal bend supports.

Part No.	Product Description	Box Qty
MC2L38CR	2-Loop x 3/8" PEX Crimp (Barbed) - Copper Manifold	1
MC3L38CR	3-Loop x 3/8" PEX Crimp (Barbed) - Copper Manifold	1
MC4L38CR	4-Loop x 3/8" PEX Crimp (Barbed) - Copper Manifold	1
MC5L38CR	5-Loop x 3/8" PEX Crimp (Barbed) - Copper Manifold	1
MC6L38CR	6-Loop x 3/8" PEX Crimp (Barbed) - Copper Manifold	1
MC7L38CR	7-Loop x 3/8" PEX Crimp (Barbed) - Copper Manifold	1
MC8L38CR	8-Loop x 3/8" PEX Crimp (Barbed) - Copper Manifold	1
MC9L38CR	9-Loop x 3/8" PEX Crimp (Barbed) - Copper Manifold	1
MC10L38CR	10-Loop x 3/8" PEX Crimp (Barbed) - Copper Manifold	1
MC11L38CR	11-Loop x 3/8" PEX Crimp (Barbed) - Copper Manifold	1
MC12L38CR	12-Loop x 3/8" PEX Crimp (Barbed) - Copper Manifold	1
MC2L12CR	2-Loop x 1/2" PEX Crimp (Barbed) - Copper Manifold	1
MC3L12CR	3-Loop x 1/2" PEX Crimp (Barbed) - Copper Manifold	1
MC4L12CR	4-Loop x 1/2" PEX Crimp (Barbed) - Copper Manifold	1
MC5L12CR	5-Loop x 1/2" PEX Crimp (Barbed) - Copper Manifold	1
MC6L12CR	6-Loop x 1/2" PEX Crimp (Barbed) - Copper Manifold	1
MC7L12CR	7-Loop x 1/2" PEX Crimp (Barbed) - Copper Manifold	1
MC8L12CR	8-Loop x 1/2" PEX Crimp (Barbed) - Copper Manifold	1
MC9L12CR	9-Loop x 1/2" PEX Crimp (Barbed) - Copper Manifold	1
MC10L12CR	10-Loop x 1/2" PEX Crimp (Barbed) - Copper Manifold	1
MC11L12CR	11-Loop x 1/2" PEX Crimp (Barbed) - Copper Manifold	1
MC12L12CR	12-Loop x 1/2" PEX Crimp (Barbed) - Copper Manifold	1

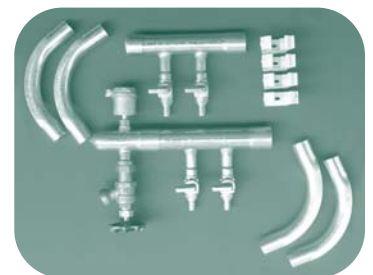

RADIANT MANIFOLDS

Copper Manifolds Only - FPT - Supply or Return [2, 3 & 4 Loop]

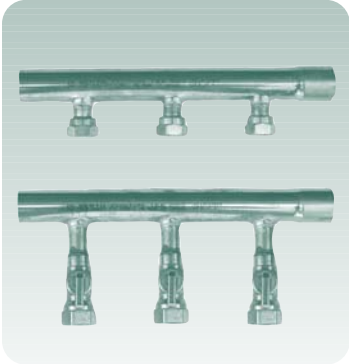

Part No.	Product Description	Box Qty
MC2L	1" x 1/2" FPT No Valves x 2 Outlets - 3" OC	1
MC3L	1" x 1/2" FPT No Valves x 3 Outlets - 3" OC	1
MC4L	1" x 1/2" FPT No Valves x 4 Outlets - 3" OC	1
MC2LBV	1" x 1/2" FPT with Valves x 2 Outlets - 3" OC	1
MC3LBV	1" x 1/2" FPT with Valves x 3 Outlets - 3" OC	1
MC4LBV	1" x 1/2" FPT with Valves x 4 Outlets - 3" OC	1

Copper Manifold Parts/Accessories

Part No.	Product Description	Box Qty
MCENDTAP	End Cap with 1/8" & 1/2" FPT Tappings	1
MCEND	End Cap less tappings - 1" Sweat Cap	1
MCPV12	1/2" MPT Purge (Drain) Valve	1
MCAV18	Air Vent 1/8" - Automatic	1
MCCLIC1X	1" Easy-Clc for mounting Copper Manifold	1
MBSET	Manifold Bracket Set - for 1" & 1-1/4" Copper Manifolds/Headers	1

Stainless Steel Supply/Return Manifold Kits - Complete

Kit includes Supply header with balancing valves, Return headers with balancing flow meters, mounting bracket set, PEX to manifold connectors and metal bend supports.

Part No.	Product Description	Box Qty
Please note that 5/8" is only available up to 8 loops maximum, and that 3/4" only available up to 6 loops maximum.		

MS2L38	2-Loop x 3/8" PEX x Manifold - Stainless Steel	1
MS3L38	3-Loop x 3/8" PEX x Manifold - Stainless Steel	1
MS4L38	4-Loop x 3/8" PEX x Manifold - Stainless Steel	1
MS5L38	5-Loop x 3/8" PEX x Manifold - Stainless Steel	1
MS6L38	6-Loop x 3/8" PEX x Manifold - Stainless Steel	1
MS7L38	7-Loop x 3/8" PEX x Manifold - Stainless Steel	1
MS8L38	8-Loop x 3/8" PEX x Manifold - Stainless Steel	1
MS9L38	9-Loop x 3/8" PEX x Manifold - Stainless Steel	1
MS10L38	10-Loop x 3/8" PEX x Manifold - Stainless Steel	1
MS11L38	11-Loop x 3/8" PEX x Manifold - Stainless Steel	1
MS12L38	12-Loop x 3/8" PEX x Manifold - Stainless Steel	1

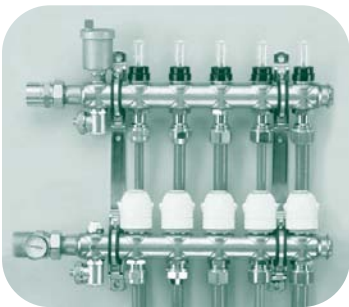

Optional accessories available:
Zone Valves, temperature gauge port and auto air vent

MS2L12	2-Loop x 1/2" PEX x Manifold - Stainless Steel	1
MS3L12	3-Loop x 1/2" PEX x Manifold - Stainless Steel	1
MS4L12	4-Loop x 1/2" PEX x Manifold - Stainless Steel	1
MS5L12	5-Loop x 1/2" PEX x Manifold - Stainless Steel	1
MS6L12	6-Loop x 1/2" PEX x Manifold - Stainless Steel	1
MS7L12	7-Loop x 1/2" PEX x Manifold - Stainless Steel	1
MS8L12	8-Loop x 1/2" PEX x Manifold - Stainless Steel	1
MS9L12	9-Loop x 1/2" PEX x Manifold - Stainless Steel	1
MS10L12	10-Loop x 1/2" PEX x Manifold - Stainless Steel	1
MS11L12	11-Loop x 1/2" PEX x Manifold - Stainless Steel	1
MS12L12	12-Loop x 1/2" PEX x Manifold - Stainless Steel	1

MS2L58	2-Loop x 5/8" PEX x Manifold - Stainless Steel	1
MS3L58	3-Loop x 5/8" PEX x Manifold - Stainless Steel	1
MS4L58	4-Loop x 5/8" PEX x Manifold - Stainless Steel	1
MS5L58	5-Loop x 5/8" PEX x Manifold - Stainless Steel	1
MS6L58	6-Loop x 5/8" PEX x Manifold - Stainless Steel	1
MS7L58	7-Loop x 5/8" PEX x Manifold - Stainless Steel	1
MS8L58	8-Loop x 5/8" PEX x Manifold - Stainless Steel	1

MS2L34	2-Loop x 3/4" PEX x Manifold - Stainless Steel	1
MS3L34	3-Loop x 3/4" PEX x Manifold - Stainless Steel	1
MS4L34	4-Loop x 3/4" PEX x Manifold - Stainless Steel	1
MS5L34	5-Loop x 3/4" PEX x Manifold - Stainless Steel	1
MS6L34	6-Loop x 3/4" PEX x Manifold - Stainless Steel	1

RADIANT MANIFOLDS

Stainless Steel Manifolds Only - Supply/Return

Part No.	Product Description	Box Qty
MS2L	2-Loop Supply/Return Only - No Fittings - Stainless Steel	1
MS3L	3-Loop Supply/Return Only - No Fittings - Stainless Steel	1
MS4L	4-Loop Supply/Return Only - No Fittings - Stainless Steel	1
MS5L	5-Loop Supply/Return Only - No Fittings - Stainless Steel	1
MS6L	6-Loop Supply/Return Only - No Fittings - Stainless Steel	1
MS7L	7-Loop Supply/Return Only - No Fittings - Stainless Steel	1
MS8L	8-Loop Supply/Return Only - No Fittings - Stainless Steel	1
MS9L	9-Loop Supply/Return Only - No Fittings - Stainless Steel	1
MS10L	10-Loop Supply/Return Only - No Fittings - Stainless Steel	1
MS11L	11-Loop Supply/Return Only - No Fittings - Stainless Steel	1
MS12L	12-Loop Supply/Return Only - No Fittings - Stainless Steel	1

Plastic Modular Supply/Return HydroLock Manifold Kits - Complete

Kit includes Starter kit, purge valves, air vents, Supply modules with balancing valve, Return module with flow meter, locking keys, PEX to manifold connectors, metal bend supports and mounting bracket set.

Part No.	Product Description	Box Qty
Please note that 5/8" is only available up to 10 loops maximum, and that 3/4" only available up to 8 loops maximum.		
MP2L38	2-Loop x 3/8" PEX x Manifold - HydroLock Manifold	1
MP3L38	3-Loop x 3/8" PEX x Manifold - HydroLock Manifold	1
MP4L38	4-Loop x 3/8" PEX x Manifold - HydroLock Manifold	1
MP5L38	5-Loop x 3/8" PEX x Manifold - HydroLock Manifold	1
MP6L38	6-Loop x 3/8" PEX x Manifold - HydroLock Manifold	1
MP7L38	7-Loop x 3/8" PEX x Manifold - HydroLock Manifold	1
MP8L38	8-Loop x 3/8" PEX x Manifold - HydroLock Manifold	1
MP9L38	9-Loop x 3/8" PEX x Manifold - HydroLock Manifold	1
MP10L38	10-Loop x 3/8" PEX x Manifold - HydroLock Manifold	1
MP11L38	11-Loop x 3/8" PEX x Manifold - HydroLock Manifold	1
MP12L38	12-Loop x 3/8" PEX x Manifold - HydroLock Manifold	1
MP2L12	2-Loop x 1/2" PEX x Manifold - HydroLock Manifold	1
MP3L12	3-Loop x 1/2" PEX x Manifold - HydroLock Manifold	1
MP4L12	4-Loop x 1/2" PEX x Manifold - HydroLock Manifold	1
MP5L12	5-Loop x 1/2" PEX x Manifold - HydroLock Manifold	1
MP6L12	6-Loop x 1/2" PEX x Manifold - HydroLock Manifold	1
MP7L12	7-Loop x 1/2" PEX x Manifold - HydroLock Manifold	1
MP8L12	8-Loop x 1/2" PEX x Manifold - HydroLock Manifold	1
MP9L12	9-Loop x 1/2" PEX x Manifold - HydroLock Manifold	1
MP10L12	10-Loop x 1/2" PEX x Manifold - HydroLock Manifold	1
MP11L12	11-Loop x 1/2" PEX x Manifold - HydroLock Manifold	1
MP12L12	12-Loop x 1/2" PEX x Manifold - HydroLock Manifold	1

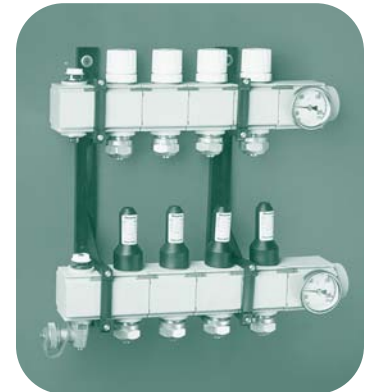

Technical Data

Operating Temperature Max: 170°F
 Operating Pressure Max: 72 psi
 Inlet: 1-1/4" MPT
 Flow Meters: 0 - 1.05 gpm

(CONT'D ON NEXT PAGE)

RADIANT MANIFOLDS

(CONT'D FROM PREVIOUS PAGE)

Plastic Modular Supply/Return HydroLock Manifold Kits - Complete

Kit includes Starter kit, purge valves, air vents, Supply modules with balancing valve, Return module with flow meter, locking keys, PEX to manifold connectors, metal bend supports and mounting bracket set.

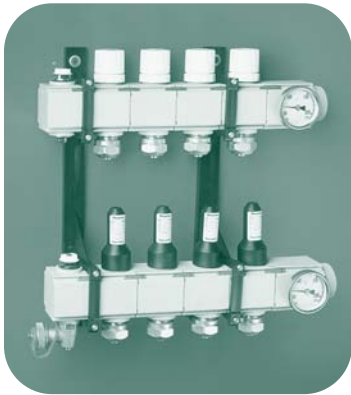

Part No. **Product Description** **Box Qty**
Please note that 5/8" is only available up to 10 loops maximum, and that 3/4" only available up to 8 loops maximum.

MP2L58	2-Loop x 5/8" PEX x Manifold - HydroLock Manifold	1
MP3L58	3-Loop x 5/8" PEX x Manifold - HydroLock Manifold	1
MP4L58	4-Loop x 5/8" PEX x Manifold - HydroLock Manifold	1
MP5L58	5-Loop x 5/8" PEX x Manifold - HydroLock Manifold	1
MP6L58	6-Loop x 5/8" PEX x Manifold - HydroLock Manifold	1
MP7L58	7-Loop x 5/8" PEX x Manifold - HydroLock Manifold	1
MP8L58	8-Loop x 5/8" PEX x Manifold - HydroLock Manifold	1
MP9L58	9-Loop x 5/8" PEX x Manifold - HydroLock Manifold	1
MP10L58	10-Loop x 5/8" PEX x Manifold - HydroLock Manifold	1
MP2L34	2-Loop x 3/4" PEX x Manifold - HydroLock Manifold	1
MP3L34	3-Loop x 3/4" PEX x Manifold - HydroLock Manifold	1
MP4L34	4-Loop x 3/4" PEX x Manifold - HydroLock Manifold	1
MP5L34	5-Loop x 3/4" PEX x Manifold - HydroLock Manifold	1
MP6L34	6-Loop x 3/4" PEX x Manifold - HydroLock Manifold	1
MP7L34	7-Loop x 3/4" PEX x Manifold - HydroLock Manifold	1
MP8L34	8-Loop x 3/4" PEX x Manifold - HydroLock Manifold	1

Plastic Manifold [HydroLock] Parts

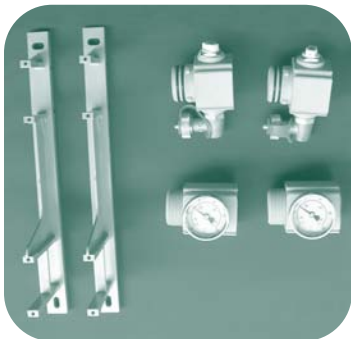

MPSKIT

Part No.	Product Description	Box Qty
MPSKIT	Starter Kit for Plastic Modular Manifold Contains: S/R End connectors, S/R threaded connectors, S/R temp gauges, drain valve, air bleeder, RED/BLUE locking keys & mounting bracket.	1
MPSUP	Supply Module with Balancing Valve - for Plastic Modular Manifold	1
MPRET	Return Module with Flow-Meter Indicator - for Plastic Modular Manifold	1
MPLKR	Locking Key - RED	1
MPLKB	Locking Key - BLUE	1
MPBV	1" FPT Shut-off Valve - Ball-type w/gasket	1

Stainless Steel & Plastic Manifold Accessories

Part No.	Product Description	Box Qty
MCON38	3/8" PEX to Manifold Connector (Pair)	1pr
MCON12	1/2" PEX to Manifold Connector (Pair)	1pr
MCON58	5/8" PEX to Manifold Connector (Pair)	1pr
MCON34	3/4" PEX to Manifold Connector (Pair)	1pr
MCAP	Manifold Connector Cap (Pair)	1pr
MSAV	Air Vent for Stainless Steel Manifolds - 1/2" BSP Male Thread *Will Not Fit 1/2" NPT	1

Manifold Mounted Zone Valves



MPZV



MSZV

Part No.	Product Description	Box Qty
MPZV	4-Wire Manifold-Mount Zone Valve for Plastic Modular Manifolds	1
MSZV	4-Wire Manifold-Mount Zone Valve for Stainless Steel Manifolds - 'Pop-up Head'	1
MPSZV	2-Wire Manifold-Mount Zone Valve for Plastic & Stainless Steel Manifolds - 'Pop-up Head'	1

ACCESSORIES

Tubing Uncoilers

Part No.	Product Description	Box Qty
TU1	PEX Tubing Uncoiler / Dispenser	1



Tubing Cutter and Replacement Blade

Part No.	Product Description	Box Qty
TC	PEX Tubing Cutter	1
TCB	PEX Tubing Cutter Replacement Blade	1



Installation Staples, Clamps and Supports

Part No.	Product Description	Box Qty
SGH	Hand Staple Gun	1
SGHP	Pneumatic Hand Staple Gun	1
SG38	3/8" Plastic Staples 100/bx	100
SG12	1/2" Plastic Staples 100/bx	100
SG58	5/8" Plastic Staples 100/bx	100
SG34	3/4" Plastic Staples 100/bx	100

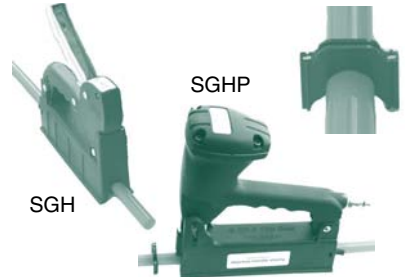

Part No.	Product Description	Bag Qty
PC12	Plastic Clamp (Strap) for 1/2" PEX Tubing - 100/bg	100
PC34	Plastic Clamp (Strap) for 3/4" PEX Tubing - 50/bg	50
PC1	Plastic Clamp (Strap) for 1" PEX Tubing - 50/bg	50



SC12	Ear-Suspension Clamp for 1/2" PEX Tubing - 100/bg	100
SC34	Ear-Suspension Clamp for 3/4" PEX Tubing - 50/bg	50
SC1	Ear-Suspension Clamp for 1" PEX Tubing - 50/bg	50

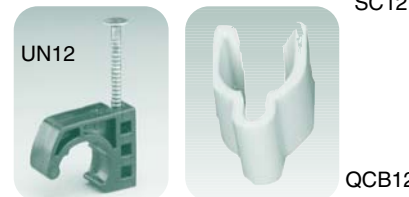

UN38	Plastic U-Nails for 3/8" PEX Tubing - 100/bg	100
UN12	Plastic U-Nails for 1/2" PEX Tubing - 100/bg	100
UN5834	Plastic U-Nails for 5/8" & 3/4" PEX Tubing - 50/bg	50
UN34	Plastic U-Nails for 3/4" PEX Tubing - 100/bg	100
UN1	Plastic U-Nails for 1" PEX Tubing - 50/bg	50
QCB12	Quick-Clip for mounting 1/2" PEX tubing to rebar wire	250
QCB34	Quick-Clip for mounting 3/4" PEX tubing to rebar wire	250



WT	Wire-Ties, Plastic - @ 7" Long - 100/bg	100
----	---	-----

Part No.	Product Description	Bag Qty
MBS38	90° Metal Bend Support for 3/8" PEX Tubing	50
MBS12	90° Metal Bend Support for 1/2" PEX Tubing	50
MBS58	90° Metal Bend Support for 5/8" PEX Tubing	50
MBS34	90° Metal Bend Support for 3/4" PEX Tubing	25



PL3812H	Plastic Elbow Sleeve for 3/8" or 1/2" PEX Tubing	1
PL58H	Plastic Elbow Sleeve for 5/8" PEX Tubing	1
PL34H	Plastic Elbow Sleeve for 3/4" PEX Tubing	1

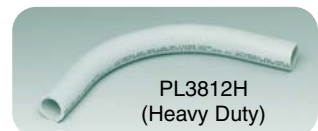

PL3812	Plastic Elbow Conduit for 3/8" or 1/2" PEX Tubing	1
PL58	Plastic Elbow Conduit for 5/8" PEX Tubing	1
PL34	Plastic Elbow Conduit for 3/4" PEX Tubing	1
PL1	Plastic Elbow Conduit for 1" PEX Tubing	1

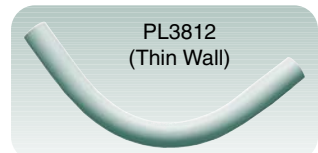

Part No.	Product Description	Box Qty
CLIC38	#12 Clics - 3/8" 'Press and Snap' Pipe Clamps - 100/bx	100
CLIC12	#15 Clics - 1/2" 'Press and Snap' Pipe Clamps - 100/bx	100
CLIC1	#28 Clics - 1" 'Press and Snap' Pipe Clamps - 50/bx	50



ACCESSORIES

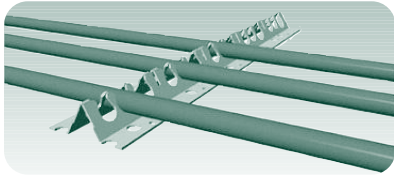

Plastic Pipe-Trak

Part No.	Product Description	Bundle Qty
PT	Pipe-Trak for 3/8", 1/2" & 5/8" PEX Tubing - 4' Long	25

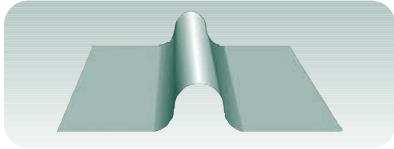

Heat Transfer Plate [Aluminum]

Part No.	Product Description	Bundle Qty
HTP12	Aluminum Heat Transfer Plates for 1/2" PEX Tubing - 50/bundle Only	50

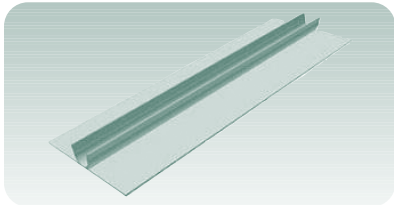

Radiant Side-Trak [Extruded Aluminum]

Part No.	Product Description	Box Qty
RT38S	3/8" Radiant Side-Trak 5" x 48"	1
RT38SBX	3/8" Radiant Side-Trak 5" x 48" - 20/bx	20
RT12S	1/2" Radiant Side-Trak 5" x 48"	1
RT12SBX	1/2" Radiant Side-Trak 5" x 48" - 20/bx	20

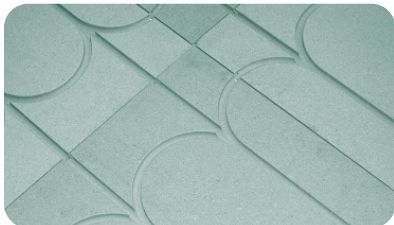

OnePanel - Pre-Engineered Floor Heating System [3/8" PEX Tubing Only]

Part No.	Product Description	Box Qty
PB38	OnePanel Radiant Retention Panel 24" x 24" x 5/8"	5

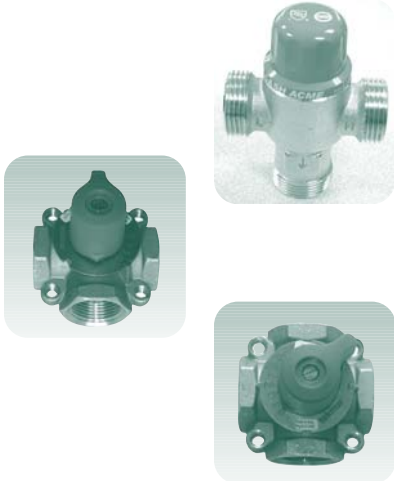

Mixing Valves

Part No.	Product Description	Box Qty
110HX34	3/4" 3-Way Thermostatic Mixing Valve (CV=3)	1
110HX1	1" 3-Way Thermostatic Mixing Valve (CV=3.5)	1
115HS1	1" 3-Way Hi-Capacity Thermostatic Mixing Valve (CV=4)	1
710	3/4" 3-Way Brass Mixing Valve (CV=7)	1
711	1" 3-Way Brass Mixing Valve (CV=14)	1
712	1-1/4" 3-Way Brass Mixing Valve (CV=21)	1
713	1-1/2" 3-Way Brass Mixing Valve (CV=32)	1
714	2" 3-Way Brass Mixing Valve (CV=51)	1
720	3/4" 4-Way Brass Mixing Valve (CV=7)	1
721	1" 4-Way Brass Mixing Valve (CV=14)	1
722	1-1/4" 4-Way Brass Mixing Valve (CV=21)	1
723	1-1/2" 4-Way Brass Mixing Valve (CV=32)	1
724	2" 4-Way Brass Mixing Valve (CV=51)	1
741	Mixing Valve 24v Actuating Motor - Floating Action	1

Pressure Balancing Valves

Part No.	Product Description	Box Qty
PBV34	3/4" Pressure Balancing Valve - Angled	1
PBV1	1" Pressure Balancing Valve - Angled	1

Temperature Gauges

Part No.	Product Description	Box Qty
TG12S	2-1/2" Temperature Gauge w/ 1/2" Sweat well	1
TG12M	2-1/2" Temperature Gauge w/ 1/2" MPT well	1
TGS	2-1/2" Temperature Gauge - Strap-On Spring	1

MISCELLANEOUS ITEMS

Alberta Tee

Large Copper Header Manifolds - [6 Foot Length]

Part No.	Product Description	Box Qty
LCM11224	1" x 1/2" x 24 Outlets - 3" OC **	5
LCM13412	1" x 3/4" x 12 Outlets - 6" OC **	4
LCM1253424	1-1/4" x 3/4" x 24 Outlets - 3" OC **	4
LCM1253418	1-1/4" x 3/4" x 18 Outlets - 4" OC **	4
LCM1253412	1-1/4" x 3/4" x 12 Outlets - 6" OC **	4
LCM1503418	1-1/2" x 3/4" x 18 Outlets - 4" OC **	3
LCM1503412	1-1/2" x 3/4" x 12 Outlets - 6" OC **	3
LCM23418	2" x 3/4" x 18 Outlets - 4" OC **	2
LCM23412	2" x 3/4" x 12 Outlets - 6" OC **	2
LCM2118	2" x 1" x 18 Outlets - 4" OC **	2
LCM2112	2" x 1" x 12 Outlets - 6" OC **	2

Large Copper Specialty Manifolds - Crimp (Barbed) - [6 Foot Length]

Part No.	Product Description	Box Qty
LCM11224CBV	1" x 1/2" PEX Crimp [Barb] Fittings with Valves x 24 Outlets - 3" OC **	5
LCM11224C	1" x 1/2" PEX Crimp [Barb] Fittings NO Valves x 24 Outlets - 3" OC **	5



LCM1253412

Ball Valve

Mini-Ball Valve for larger manifold requirements

Part No.	Product Description	Box Qty
BV34B	3/4" Female Sweat x 3/4" Female Sweat Mini-Ball Valve - Blue Handle. For use on Large Copper Header Manifolds.	1
BV34R	3/4" Female Sweat x 3/4" Female Sweat Mini-Ball Valve - Red Handle. For use on Large Copper Header Manifolds.	1

* Add either a 1/2", 5/8" or 3/4" PEX (barbed or compression) x 3/4" Male sweat adapter for many manifold requirements.



Copper Manifolds Only - Crimp (Barbed) - [Supply or Return - 2, 3 & 4 Loop]

Part No.	Product Description	Box Qty
MC2LCBV	1" x 1/2" PEX Crimp [Barbed] with Valves x 2 Outlets - 2" OC **	5
MC3LCBV	1" x 1/2" PEX Crimp [Barbed] with Valves x 3 Outlets - 2" OC **	5
MC4LCBV	1" x 1/2" PEX Crimp [Barbed] with Valves x 4 Outlets - 2" OC **	5

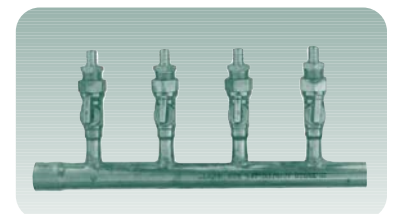

MISCELLANEOUS ITEMS



Insul-Tarp Insulation

Part No.	Product Description	Roll Qty
IT625	6' x 25' x 1/2" Insul-Tarp Insulation - 150 Sqr. Ft.	1
IT650	6' x 50' x 1/2" Insul-Tarp Insulation - 300 Sqr. Ft.	1
IT1225	12' x 25' x 1/2" Insul-Tarp Insulation - 300 Sqr. Ft.	1
IT1250	12' x 50' x 1/2" Insul-Tarp Insulation - 600 Sqr. Ft.	1
IT16125FBF	16" x 125' Double Bubble - Foil-Bubble-Foil - 166 Sqr. Ft.	1
IT4125FBP	4' x 125' Double Bubble - Foil-Bubble-Poly - 500 Sqr. Ft.	1
IT6125FBP	6' x 125' Double Bubble - Foil-Bubble-Poly - 750 Sqr. Ft.	1

For additional product info go to www.insulationsolutions.com

Axiom Industries - Glycol Feeder Systems

Part No.	Product Description	Box Qty
AX200	6 Gallon Glycol Feeder System	1
AX300	17 Gallon Glycol Feeder System	1
AX100	50 Gallon Glycol Feeder System	1
AX100HP	50 Gallon High-Pressure Glycol Feeder System	1
AX100L	100 Gallon Glycol Feeder System	1
AX100LHP	100 Gallon High-Pressure Glycol Feeder System	1
AXALARM	Alarm Panel Only - RIAI-01	1
AXWALLMNT	Wall-Mounting Shelf for 6 & 17 Gallon Feeder	1
AXFLOATSWT	Low Level Float Switch	1

For additional product info go to www.axiomind.com

Turbo-Max Instantaneous Water Heaters

Part No.	Product Description	Box Qty
T23	T-23 Instantaneous Indirect Water Heater	1
T24	T-24 Instantaneous Indirect Water Heater	1
T33	T-33 Instantaneous Indirect Water Heater	1
T34	T-34 Instantaneous Indirect Water Heater	1
T45	T-45 Instantaneous Indirect Water Heater	1
T65	T-65 Instantaneous Indirect Water Heater	1
T109	T-109 Instantaneous Indirect Water Heater	1

For additional product info go to www.thermo2000.com

Snow Melt Brazed Plate Heat Exchangers

Part No.	Product Description	Box Qty
HX60	Braze Plate Heat Exchanger - 60,000 BTU - 3/4" MPT	1
HX90	Braze Plate Heat Exchanger - 90,000 BTU - 3/4" MPT	1
HX100	Braze Plate Heat Exchanger - 100,000 BTU - 3/4" MPT	1
HX125	Braze Plate Heat Exchanger - 125,000 BTU - 3/4" MPT	1
HX150	Braze Plate Heat Exchanger - 150,000 BTU - 3/4" MPT	1
HX200	Braze Plate Heat Exchanger - 200,000 BTU - 3/4" MPT	1
HX225	Braze Plate Heat Exchanger - 225,000 BTU - 3/4" MPT	1
HX250	Braze Plate Heat Exchanger - 250,000 BTU - 3/4" MPT	1
HX250LPD	Braze Plate Heat Exchanger - 250,000 BTU - 1-1/4" MPT (LPD)	1
HX300	Braze Plate Heat Exchanger - 300,000 BTU - 3/4" MPT	1
HX300LPD	Braze Plate Heat Exchanger - 300,000 BTU - 1-1/4" MPT (LPD)	1
HX350	Braze Plate Heat Exchanger - 350,000 BTU - 3/4" MPT	1
HX400LPD	Braze Plate Heat Exchanger - 400,000 BTU - 1-1/4" MPT (LPD)	1
HX500	Braze Plate Heat Exchanger - 500,000 BTU - 1-1/4" MPT	1
HX700	Braze Plate Heat Exchanger - 700,000 BTU - 1-1/4" MPT	1
HX900	Braze Plate Heat Exchanger - 900,000 BTU - 1-1/4" MPT	1
HX1000	Braze Plate Heat Exchanger - 1,000,000 BTU - 2" MPT	1



MISCELLANEOUS ITEMS

Snow Melt Controls

Part No.	Product Description	Box Qty
4019	Snow Melt and Setpoint Control Switch with Wall-mount Timer	1
650	Snow Melt Control - Pulse Width Modulation	1
664	Snow Detector & Melting Control - 2-zone, 2-stage boiler & mixing	1
665	Snow Detector & Melting Control - Pulse Width Modulation	1
667	Snow Detector & Melting Control - Variable Speed	1
090	Snow / Ice Sensor - 65' Cable	1
091	Snow / Ice Sensor Socket	1

SNOW MELTING CONTROL #650

This is a manually activated snow melting control. The 650 control uses a slab sensor #072 and outdoor air sensor #070 included with control to maintain a snow melt slab at a set surface temperature during snow melting. When melting system is not required, either the melting system is shut down, or the slab can be maintained at an idling temperature for faster response and improved safety. The built-in timer can be programmed to operate the snowmelt system for a set time period to help control energy costs.

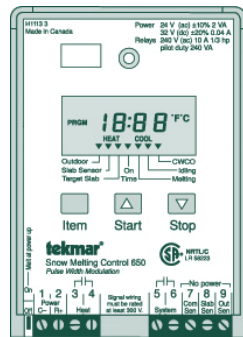

This control can be used with the snow switch part number 4019 to automatically start the system.

ELECTRONIC CONTROLLER #665 & #664

ELECTRONIC CONTROLLER #665 – Used with snow/ice detector – The control will automatically turn on and off the snow melting system.



The 665 uses a signal from the snow/ice detector & outdoor air sensor (#070 included with control). Based on outdoor temperatures and detection from snow/ice detector, system is automatically turned on to maintain a snow melt slab at a set surface temperature during snow melting. When melting system is not required, due to warm temperatures or the snow/ice detector does not require melting, the system is automatically turned off. An ideal mode is a feature of this control that will maintain the slab at minimal temperatures for faster response and improved safety.

#664 – Is designed to control up to two zones in a snow melting system.

The control automatically adjusts the mixed supply water to the snow melting system by controlling up to two boilers and a single mixing device. For mixing, the 664 can use a variable speed injection pump, a floating action mixing valve or a 4-20 mA device when used with snow/ice detector.

Additional features include: Optional priority zoning; Slab protection; Boiler protection; Manual override; Warm Weather Shut Down; Cold Weather Shut Down; Pump & Valve exercising.



For additional product info go to www.tekmarcontrols.com

SNOW SWITCH #4019

Application

For use in residential and light commercial applications. Senses both temperature and precipitation. Its internal contacts can be used to trigger low voltages such as zone valves, pump relays, or boiler controls. A single floating electro-mechanical relay with a five amp rating is provided for control purposes. System continues to operate for 5 hours after precipitation stops to insure effective snow melting.



SNOW/ICE SENSOR #090 & #091

This is a commercial grade sensor that sits flush with the surface and will automatically activate the snow melting system should either snow or ice start to accumulate. The sensor knows when to activate and stop the snow melting system. The sensor must be used with a tekmar snow melting control.





Expect More from Rathe Associates & Get It.

*1650 New Highway
Farmingdale, NY 11735*

631.822.1200

718.347.4747

fax 631.822.1400

www.ratheassoc.com



TR-001