



---

---

The Original OEM Manufacturer

---

---



---

---

For Over 66 Years

---

---

**Your Single Source!**



# The Crown 2016 Product catalog

## Welcome!...to the Crown family of products

### About us...

#### **Crown Engineering Corporation...the Manufacturer!**

Crown Engineering Corporation is one of the largest manufacturers of electrodes, flame rods, and probes for ignition related applications regarding oil and gas fired equipment. We manufacture many of the electrodes for today's waste oil burners. Our ignition electrodes can be found in **Beckett AFII** burners, **Wayne Blue Angel** oil burners, **Carlin's Elite** oil burners, **Midco** power gas burners, **Wayne** power gas burners, **Fulton** boilers, and **Kewanee** boilers. We have designed and supplied ignition products for grain drying equipment. Our products can even be found in hot water heaters, pressure washers, and diesel truck heaters, of all places!

Crown Engineering Corporation is also a manufacturer of terminal connectors. Our connectors are used in power source applications between electrode and transformer. We also manufacture connector to connector cable assemblies for **Fulton Boiler Co.**

#### **Crown Engineering Corporation...the Distributor!**

In addition to manufacturing electrodes and terminals for our customers we are swamped with numerous requests for other related products. We rose to the demands of our customers needs. After we began our, "Single Source!", campaign, it lead to an onslaught of numerous distribution items. These products range from industrial igniters, couplers, putty, gauge glass and fractional v-belts.

### In Closing...

Crown Engineering is proud to present our 2016 Product Catalog, featuring over 1800 different cataloged products. Take the time to look through it. This is our most informative and organized edition ever! Our OEM electrode section has extras, such as, OEM part numbers and model number information, and updated photos and line art for many of the old Crown favorites have been added, and continuous page numbers with Section numbers instead of alpha sections. Our "on edge description tabs," makes thumbing through sections easier than ever. So, don't judge our book by it's cover! Literally! Take a look inside, there's more!.

We graciously welcome you, and thank you for choosing our company as a source of supply. We hope to serve you humbly for many years to come. If at any time you are not completely satisfied with the product(s), and service we offer, please do not hesitate to openly discuss the problem with us. With Crown there is never a problem that cannot be solved. We think of you as more than just a customer...we treat all our customers like family!. We look forward to hearing from you.

Sincerely,

*Michael J. Palmer*  
President



## Product Index “A” through “H”

<b>A</b>		Ceramic putty - Thermeez®	79	Filter mounting head for QS III	94
A pump strainer gaskets	100	Ceramic roping	77	Filter modification mounting kit	94
A pump strainers	98	Champion Spark Plugs	40	Friction Rings - Brass	114
Adams/Beckett electrode kit	32	Chem Flush-1	104	Flame detectors	67, 72
Air Cones for Beckett Burners	123	Chem Flush valve	104	Flame detector cad cell	72
Air Cones for Wayne Burners	122	Chem Flush valve sight tube	104	Flame rods, Auburn®	43
Anti-Hum Device - Silent Flow	91	Circulator couplings	86	Flame rods, Crown	58, 59
Armstrong / B & G Couplers	85	Circulator lube oil	86	Flexible braided hose	97, 98
Aquastat immersion wells	112	CO <sup>2</sup> blow out guns	108, 109	Flow Control® de-aerator	96
Auburn® electric feed-throughs	39	CO <sup>2</sup> cartridges 6, 12 & 16 gram	110	Fulflo filter elements	92
Auburn® igniters & flame rods	43-48	Compound gauge - Color coded	96	Fusible valves - Firomatic®	102, 103
Auburn® liquid level electrodes	49	Control Blast	109	Furnace cement	81
Auburn® observation ports	51	Conversion chart	30	Fulflo gaskets	101
		Copper oil Lines - Streamline®	91		
<b>B</b>		Cotton filter elements	92	<b>G</b>	
Beckett air cones	123	Coupler tubing, Bulk	84	Gaskets	79 - 81
Beckett electrode kits	35 - 38	Coupling cutter tool	84, 106	Gasket, Utility roll	80
Beckett flange kit	79	Coupling end caps	84	G. E. Door Gasket	80
Beckett gaskets	79	Coupling kit	83	Gauges	95, 96
Beckett Igniton Leads Set	31	Coupling tools	106	Gauge Glass Valves	114
B & G Couplers / Armstrong	85	Cover gasket for		Gauge Glass - High Pressure	115
Blow out gun	108, 109	Heil / Bradford / Olsen	80	Gauge Glass protector rods	118
Boards, refractory	79			Gauge Glass porcelain cutter	108
Boots, silicone & ceramic	50, 51	<b>D</b>		Gauge Glass - Redline	117
Braided flex hose	97, 98	De-aerator - Flow Control®	96	Gauge Glass - Redline heavy wall	118
Braided Rope - High Temp.	77	De-greaser	104	Gauge Glass - Standard	115
Brass friction rings	114	Decimal Conversion Chart	30	Gauge Glass Washers - Marvel®	113
Beckett solid state ignitor	36	Digital pocket dial thermometer	105	Gauge Glass packing nut kit	114
Burner Coupling & Kits	83, 84	DO-ALL+ Furnace cement	81	Gauge Glass Washers - Standard	114
Burner Couplings - Bulk & OEM	83, 84			GTO-15 cable	68
Burner Couplings, Pioneer	83	<b>E</b>			
Burner Gaskets - Assorted	80, 81	Electrode replacement rod paks	67	<b>H</b>	
Buss Bars	67	Electrode Setting Gauges	110	Handi-Kutter & Blades	84
		Electrode tip benders	109	Handi-Kutter & Kits	84
<b>C</b>		Electrodes, All	5 - 29	Heavy duty coupling cutter	106
Carlin electrode kits	35	Electrodes, OEM	5 - 28	Heavy Wall Red Line GG	118
CA Series industrial		Electrodes, Standard	29	Heil/Brad/Olsen cover gasket	80
igniters & flame Rods	52	Electrode ignition kits	32 - 35	Hi-Temp rope	77
Cable Reels - Empty	68	Electric Feed-throughs	39	Hi-Temp Wire Leads	76
Cable, GTO-15 - 7mm	68	End cones, Beckett	123	Honeywell cad cell kit	67
Cable leads for Honeywell	76	End cones, Wayne	122	Honeywell Flame detectors	67
Cable leads for Weil-McLain	76			Hub-Adaptors, Splined	84
Cable, Silicone - 7mm	68	<b>F</b>		Hydronic circulator lube oil	86
Cad Cell Eyes	72	Fast drying de-greaser	104		
Carlin gaskets	79 - 81	Fiberglass rope	81		
Carlin gasket kit	81	Fiberfrax® gasket paper	78		
Cartridges, CO <sup>2</sup>	110	Fiberglass tape	78		
Ceramic Boots with terminals	50, 51	Filters	92, 93, 94		
Ceramic cutting tool	108	Filter gaskets	100		
Ceramic Fiber Blankets	76	Filter mounting bracket	94		



## Product Index “I” through “Z”

<b>I</b> Igniter development page 66 Igniters & Flame rods, Auburn® 43 - 48 Igniters & Flame rodss, Crown 52 - 65 Igniter Hardware 71, 72 Ignition terminals 73, 74 Ignition terminal kits 69, 70 Immersion wells aquastat 112 Inspection mirrors, Telescoping 105 Insulator, Standard 29 Insulators, Spider 28  <b>J</b> J,H,S pump strainer gaskets 100 J,H,S pump strainers 98 Jumper leads 68  <b>K</b> Koupling King II products 83, 84 KK400 Ultra Koupling Kit 83  <b>L</b> Lineman's crimper 106, 110 Lineman's strip n' crimp 110 Liquid level probes 49 Low voltage test leads 68  <b>M</b> Manufacturers Rep Lisiting 90 Marvel® gauge glass washers 113 Match holder 105 Miller gaskets & kits 80, 81 Miller oil line kit 91 Mirror, telescoping 105 Moroso® crimping tools 107  <b>N</b> Nozzle wrench tool 109  <b>O</b> Observation Ports - Auburn 51 Observation Ports - Lenz Brand 51 OEM coupling kits 83 OEM electrodes 5 - 28 Oil Filters 92 - 94 Oil lines - Flexible 97, 98 Oil line flexible, Riello 98 Oil line tubing, Copper 91 Oil line, Miller 91 Oil safety valves - Webster® 102	O-ring gasket, Riello 100 <b>P</b> Packing nuts & kit 114 Pioneer coupling products 83, 84 Pliers, Lineman 106,110 Pocket dial thermometer 105 Porcelain & glass cutter 108 Pressure & cut-off test kit 111 Pressure gauges 95 Prodes - S/S & Brass 51 Pump cover gasket, Riello 100 Pump strainer gskt & kits 98 - 101 Pump test kits 111, 112  <b>Q</b> Quick-Spin III filtration system 93, 94 Quick-Spin III filtration kits 94  <b>R</b> Ratchet box wrench 109 Rayon filter 92 Ready Fit™ couplings 83 Red line gauge glass 117, 118 Replacement blades for 40402 106 Refractory boards 79 Riello air tube gasket 80 Riello flexible hose 98 Riello o-ring 100 Riello pump strainer 99 Riello pump & vacuum tester 111 Rope, Braided 77 Rope, Fiberglass 81 Rope, Twisted 77  <b>S</b> Setting gauge, Electrode 110 Silent Flow 91 Silicone Boots 50 Silicone cable 68 Silicone Tape 112 Smoke Candles - Superior 104 Smoke Emitters - Regin 104 Smoke test paper 104 Solderless terminals 75 Solderless Wire Terminals & Kits 75 Soot kutter 107 Spark plug terminals & boots 50, 51 Spark plugs, Champion 39 - 42 Spark plug crimping tool 107 Spin-on filters 93, 94 Spring / Coiled Circulator Couplers 85	Standard gauge glass washers 114 Strainers 98, 99  <b>T</b> Taco couplings 85 Tape, Fiberglass 78 Tank gauge - Rope type 96 Target boards, Refractory 79 Telescoping mirror tools & kits 105 Terminal crimping tools 106, 107, 110 Terminal ignition kits 69, 70, 75 Terminal Kit - "Big Box" 75 Terminals / Rajah Style 73, 74 Test leads w/boots 68 Thermeez® ceramic putty 79 Thermo Pride cover gasket 80 Thermometers - Pocket dial 105 Thermometer with spud well 95 Tip benders, Electrode 109 Tools 105 - 110 Transformer contact kit 69, 74 Tridicator / Boiler gauges 95 Trouble Shooting Guide 82 Tubular gauge glass 115 - 118 Twisted Rope - High Temp. 77  <b>U</b> Universal gasket - No bolt holes 80 Utility gasket roll 80  <b>V</b> Vacuum gauges 95 Valker® Products, All 104 V- Belts - Fractional 119  <b>W</b> Washers, All 113, 114 Webster vacuum breaker 110 Wayne flange gaskets 79 Wayne tune up kits 31, 32 Weil-McLain tune up kit 31 Wix oil filter elements #24104 92 Woods™ Couplers & Sleeves 87 - 89  <b>X, Y</b> No entries  <b>Z</b> Zoom type - circulator lube oil 86
---	--	--





**Section 1: Electrodes**

**CROWN P/N:** 20005 **NAME:** ACE **OEM P/N:** 212096  
**MODELS:** UNKNOWN

**CROWN P/N:** 20155 **NAME:** AMERICAN STANDARD  
**OEM P/N:** 95603 **MODELS:** "E" FOR SHELLHEAD

**CROWN P/N:** 20075 **NAME:** AERO **OEM P/N:** UNKNOWN  
**MODELS:** E & EHS

**CROWN P/N:** 20165 **NAME:** AMERICAN STANDARD  
**OEM P/N:** 23411 **MODELS:** DH-23-T

**CROWN P/N:** 20076  
**NAME:** AERO  
**OEM P/N:** 27-25132100  
**MODELS:** FAFC, HF-U5, HFAFC.

**CROWN P/N:** 20188  
**NAME:** AXEMAN-ANDERSON  
**OEM P/N:** LH 144539-7 & RH 144538-7  
**MODELS:** UNKNOWN

**CROWN P/N:** 20077  
**NAME:** AERO  
**OEM P/N:** 27-25132100  
**MODELS:** FAFC, HF-U5, HFAFC.

**CROWN P/N:** 20195 **NAME:** ARMSTRONG **OEM P/N:** 215-01A  
**MODELS:** UNKNOWN

**CROWN P/N:** 20080 **NAME:** AERO **OEM P/N:** UNKNOWN  
**MODELS:** G & GHS

**CROWN P/N:** 20197 **NAME:** AUBURN **OEM P/N:** UNKNOWN  
**MODELS:** "AA" TURBULATOR

**CROWN P/N:** 20125 **NAME:** AMERICAN STANDARD  
**OEM P/N:** 11385 **MODELS:** PH

**CROWN P/N:** 20200 **NAME:** ABC / SUNRAY **OEM P/N:** UNKNOWN  
**MODELS:** UNKNOWN

**CROWN P/N:** 20135 **NAME:** AMERICAN STANDARD  
**OEM P/N:** 15156 **MODELS:** DH & PH2

**CROWN P/N:** 20205 **NAME:** ABC / SUNRAY **OEM P/N:** UNKNOWN  
**MODELS:** UNKNOWN

**CROWN P/N:** 20140 **NAME:** AMERICAN STANDARD  
**OEM P/N:** 72918 **MODELS:** ARCO FLAME OIL BURNERS

**CROWN P/N:** 20220 **NAME:** ABC / SUNRAY **OEM P/N:** SA-8892  
**MODELS:** 55A

**CROWN P/N:** 20150 **NAME:** AMERICAN STANDARD  
**OEM P/N:** 94121 **MODELS:** "E" STANDARD HIGH & LOW PRESSURE

**CROWN P/N:** 20230 **NAME:** ABC / SUNRAY **OEM P/N:** A9806-R-6 1/2  
**MODELS:** 45 & 55J



<p><b>CROWN P/N:</b> 20240 <b>NAME:</b> ABC / SUNRAY <b>OEM P/N:</b> SA-9899  <b>MODELS:</b> UNKNOWN</p>	<p><b>CROWN P/N:</b> 20395  <b>NAME:</b> BAXTER  <b>OEM P/N:</b> V9-119  <b>MODELS:</b> UNKNOWN</p>
<p><b>CROWN P/N:</b> 20245 <b>NAME:</b> ABC / SUNRAY <b>OEM P/N:</b> SA-10360  <b>MODELS:</b> 45</p>	<p><b>CROWN P/N:</b> 20396 <b>NAME:</b> BAXTER <b>OEM P/N:</b> UNKNOWN  <b>MODELS:</b> UNKNOWN</p>
<p><b>CROWN P/N:</b> 20250 <b>NAME:</b> ABC / SUNRAY <b>OEM P/N:</b> SA-10112  <b>MODELS:</b> 75</p>	<p><b>CROWN P/N:</b> 20404 <b>NAME:</b> BECKETT <b>OEM P/N:</b> UNKNOWN  <b>MODELS:</b> UNKNOWN</p>
<p><b>CROWN P/N:</b> 20310 <b>NAME:</b> ABC / SUNRAY <b>OEM P/N:</b> SA-11495  <b>MODELS:</b> 97AT &amp; 97A HILO BURNER</p>	<p><b>CROWN P/N:</b> 20410 <b>NAME:</b> BECKETT <b>OEM P/N:</b> UNKNOWN  <b>MODELS:</b> SF, AF, &amp; AFG UNDER 9" AIR TUBE</p>
<p><b>CROWN P/N:</b> 20315 <b>NAME:</b> ABC / SUNRAY <b>OEM P/N:</b> SA-11497  <b>MODELS:</b> 97AT &amp; 97A HILO BURNER</p>	<p><b>CROWN P/N:</b> 20411 <b>NAME:</b> BECKETT <b>OEM P/N:</b> UNKNOWN  <b>MODELS:</b> UNKNOWN</p>
<p><b>CROWN P/N:</b> 20325 <b>NAME:</b> ABC / SUNRAY <b>OEM P/N:</b> SA-11446  <b>MODELS:</b> 62A &amp; 96A</p>	<p><b>CROWN P/N:</b> 20412 <b>NAME:</b> BECKETT <b>OEM P/N:</b> UNKNOWN  <b>MODELS:</b> SF, AF, &amp; AFG OVER 9" AIR TUBE</p>
<p><b>CROWN P/N:</b> 20330 <b>NAME:</b> ABC / SUNRAY <b>OEM P/N:</b> SA-12823  <b>MODELS:</b> 40CN &amp; 92C</p>	<p><b>CROWN P/N:</b> 20413 <b>NAME:</b> BECKETT <b>OEM P/N:</b> UNKNOWN  <b>MODELS:</b> UNKNOWN</p>
<p><b>CROWN P/N:</b> 20335 <b>NAME:</b> ABC / SUNRAY <b>OEM P/N:</b> SA-12979  <b>MODELS:</b> MIGHTY MITE S, S1 &amp; S2</p>	<p><b>CROWN P/N:</b> 20414  <b>NAME:</b> BECKETT  <b>OEM P/N:</b> UNKNOWN  <b>MODELS:</b> MILLER FURNANCE - AF15 BURNER</p>
<p><b>CROWN P/N:</b> 20340 <b>NAME:</b> ABC / SUNRAY <b>OEM P/N:</b> UNKNOWN  <b>MODELS:</b> UNKNOWN</p>	<p><b>CROWN P/N:</b> 20415 <b>NAME:</b> BECKETT <b>OEM P/N:</b> UNKNOWN  <b>MODELS:</b> UNKNOWN</p>



**Section 1: Electrodes**

**CROWN P/N:** 20416 **NAME:** BECKETT **OEM P/N:** UNKNOWN  
**MODELS:** UNKNOWN

**CROWN P/N:** 20437 **NAME:** BECKETT **OEM P/N:** 6603250  
**MODELS:** INTERTHERM

**CROWN P/N:** 20417 **NAME:** BECKETT  
**OEM P/N:** 51096050 **MODELS:** UNKNOWN

**CROWN P/N:** 20441 **NAME:** BECKETT **OEM P/N:** 6600610 & 11  
**MODELS:** INTERTHERM

**CROWN P/N:** 20418 **NAME:** BECKETT **OEM P/N:** 5787-07 & -08  
**MODELS:** AFG & AF-90

**CROWN P/N:** 20444 **NAME:** BECKETT **OEM P/N:** 5987L & R  
**MODELS:** CF BURNER

**CROWN P/N:** 20420 **NAME:** BECKETT **OEM P/N:** UNKNOWN  
**MODELS:** UNKNOWN

**CROWN P/N:** 20455 **NAME:** BETHLEHEM **OEM P/N:** A-1186  
**MODELS:** SE-1186

**CROWN P/N:** 20422  
**NAME:** BECKETT  
**OEM P/N:** UNKNOWN  
**MODELS:** UNKNOWN

**CROWN P/N:** 20465 **NAME:** BETHLEHEM **OEM P/N:** UNKNOWN  
**MODELS:** UNKNOWN

**CROWN P/N:** 20425  
**NAME:** BECKETT  
**OEM P/N:** UNKNOWN  
**MODELS:** UNKNOWN

**CROWN P/N:** 20470 **NAME:** BETHLEHEM **OEM P/N:** 31G8101/8-2-182C  
**MODELS:** UNKNOWN

**CROWN P/N:** 20428  
**NAME:** BECKETT  
**OEM P/N:** UNKNOWN  
**MODELS:** UNKNOWN

**CROWN P/N:** 20475 **NAME:** BETTENDORF **OEM P/N:** P-4757  
**MODELS:** UNKNOWN

**CROWN P/N:** 20430  
**NAME:** BECKETT  
**OEM P/N:** UNKNOWN  
**MODELS:** UNKNOWN

**CROWN P/N:** 20480 **NAME:** BETTENDORF **OEM P/N:** ET-119  
**MODELS:** SE1855

**CROWN P/N:** 20435  
**NAME:** BECKETT  
**OEM P/N:** UNKNOWN  
**MODELS:** UNKNOWN

**CROWN P/N:** 20495 **NAME:** BETTENDORF **OEM P/N:** M7509 AND M7510  
**MODELS:** UNKNOWN





<p>CROWN P/N: 20500                  NAME: BETTENDORF                  OEM P/N: M7428 &amp; M7429                  MODELS: UNKNOWN</p>	<p>CROWN P/N: 20709 NAME: CARLIN OEM P/N: UNKNOWN                  MODELS: UNKNOWN</p>
<p>CROWN P/N: 20505                  NAME: BETTENDORF                  OEM P/N: M7512 &amp; M7513                  MODELS: UNKNOWN</p>	<p>CROWN P/N: 20710 NAME: CARLIN OEM P/N: A452                  MODELS: 500, 600 &amp; 800 CRD</p>
<p>CROWN P/N: 20510 NAME: BETTENDORF OEM P/N: M7612 &amp; M7613                  MODELS: UNKNOWN</p>	<p>CROWN P/N: 20720 NAME: CARLIN OEM P/N: A106                  MODELS: 501, 600, 601, 701, 801, 1050 &amp; 1150 CRD JACOBS LADDER</p>
<p>CROWN P/N: 20532 NAME: BETTENDORF OEM P/N: M7630 &amp; M7631                  MODELS: OHP32-3</p>	<p>CROWN P/N: 20725 NAME: CARLIN OEM P/N: UNKNOWN                  MODELS: UNKNOWN</p>
<p>CROWN P/N: 20535 NAME: BETTENDORF OEM P/N: M7658 &amp; M7659                  MODELS: OHP30-5</p>	<p>CROWN P/N: 20730 NAME: CARLIN OEM P/N: UNKNOWN                  MODELS: UNKNOWN</p>
<p>CROWN P/N: 20540 NAME: BETTENDORF OEM P/N: P-8-9884 &amp; 9885                  MODELS: UNKNOWN</p>	<p>CROWN P/N: 20760 NAME: CARLIN OEM P/N: A110                  MODELS: 150 SERIES</p>
<p>CROWN P/N: 20545 NAME: BETTENDORF OEM P/N: P-8-9312 &amp; 9313                  MODELS: UNKNOWN</p>	<p>CROWN P/N: 20770 NAME: CARLIN OEM P/N: A280                  MODELS: 98-102, 100-101, 200-201 &amp; 301 CRD 1/16" DIA ROD</p>
<p>CROWN P/N: 27247                  NAME: BLACK GOLD                  OEM P/N: BN710                  MODELS: 140, 200, &amp; 340</p>	<p>CROWN P/N: 20775 NAME: CARLIN OEM P/N: A457                  MODELS: 99FRD 1/16" DIA ROD</p>
<p>CROWN P/N: 20569 NAME: BLUERAY OEM P/N: CRN-14                  MODELS: UNKNOWN</p>	<p>CROWN P/N: 20779 NAME: CARLIN OEM P/N: A457                  MODELS: 99FRD 1/8" DIA ROD WITH 30 DEGREE TIP</p>





**Section 1: Electrodes**

**CROWN P/N:** 20780 **NAME:** CARLIN **OEM P/N:** A766 **MODELS:** 98 102, 100-101, 200-201 & 301 CRD  
 1/8" DIA. ROD WITH 30 DEGREE TIP

**CROWN P/N:** 20810 **NAME:** CENTURY **OEM P/N:** 103068-4 1/2  
**MODELS:** UNKNOWN

**CROWN P/N:** 20781 **NAME:** CARLIN **OEM P/N:** A280 **MODELS:** 98 102, 100-101, 200-201 & 301 CRD  
 1/16" DIA. ROD WITH BB

**CROWN P/N:** 20820  
**NAME:** CHICAGO EASTERN  
**OEM P/N:** P10129 & 28  
**MODELS:** RING BURNERS

**CROWN P/N:** 20782 **NAME:** CARLIN **OEM P/N:** A457  
**MODELS:** 99FRD 1/16" DIA ROD WITH BB

**CROWN P/N:** 20850 **NAME:** CHRYSLER **OEM P/N:** 1025759  
**MODELS:** UNKNOWN

**CROWN P/N:** 20786 **NAME:** CARLIN **OEM P/N:** 76141  
**MODELS:** ELITE BURNER WITH 5" AIR TUBE 2 1/2" BB

**CROWN P/N:** 20872 **NAME:** CLEAN BURN **OEM P/N:** 33183  
**MODELS:** UNKNOWN - PROPRIETARY CONTACT CLEAN BURN

**CROWN P/N:** 20787 **NAME:** CARLIN **OEM P/N:** 76158  
**MODELS:** ELITE BURNER WITH 7" AIR TUBE 4 1/2" BB

**CROWN P/N:** 20874  
**NAME:** CLEAN BURN  
**OEM P/N:** 33085 & 33086  
**MODELS:** UNKNOWN

**CROWN P/N:** 20788 **NAME:** CARLIN **OEM P/N:** 76166  
**MODELS:** ELITE BURNER WITH 9" AIR TUBE 6 1/2" BB

**CROWN P/N:** 20876 **NAME:** CLEAN BURN **OEM P/N:** 33109 REV 2 & 33108  
**MODELS:** CB-2000

**CROWN P/N:** 20762 **NAME:** CARLIN **OEM P/N:** 76174  
**MODELS:** ELITE BURNER WITH 11" AIR TUBE 8 1/2" BB

**CROWN P/N:** 20900 **NAME:** CLEAVER-BROOKS **OEM P/N:** 94-20  
**MODELS:** UNKNOWN

**CROWN P/N:** 20795 **NAME:** CENTURY **OEM P/N:** 54991  
**MODELS:** UNKNOWN

**CROWN P/N:** 20905 **NAME:** CLEAVER-BROOKS **OEM P/N:** 94-A-179-1  
**MODELS:** UNKNOWN

**CROWN P/N:** 20805 **NAME:** CENTURY **OEM P/N:** 103068-4  
**MODELS:** UNKNOWN

**CROWN P/N:** 20910 **NAME:** CLEAVER-BROOKS **OEM P/N:** 435-65  
**MODELS:** P & M 25 TO 40

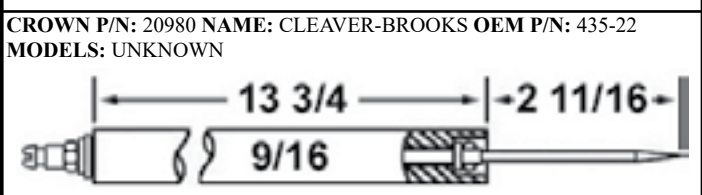
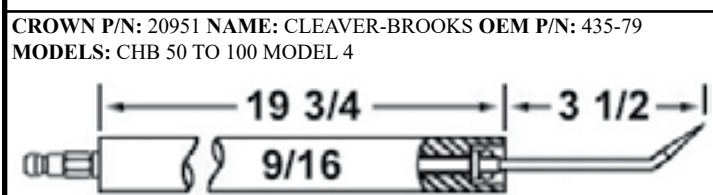
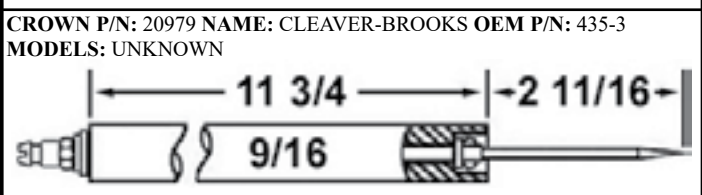
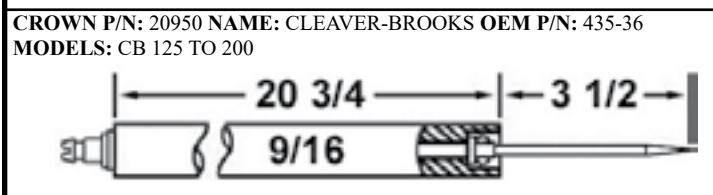
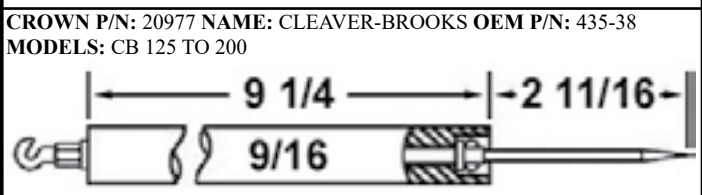
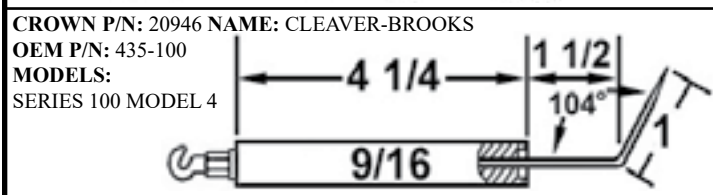
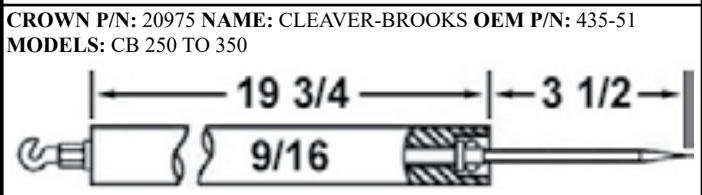
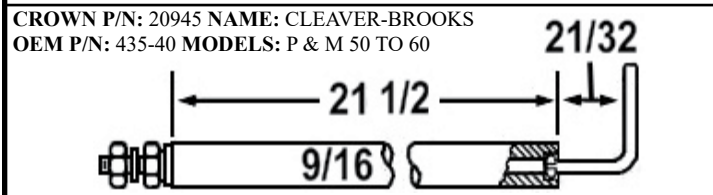
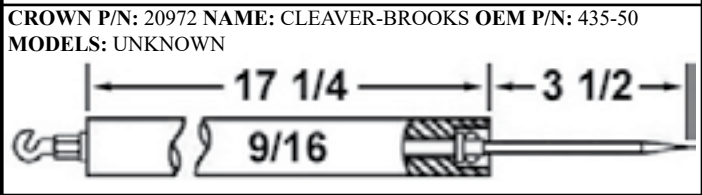
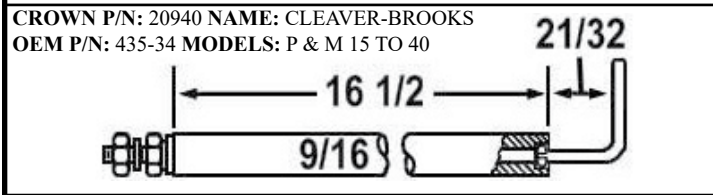
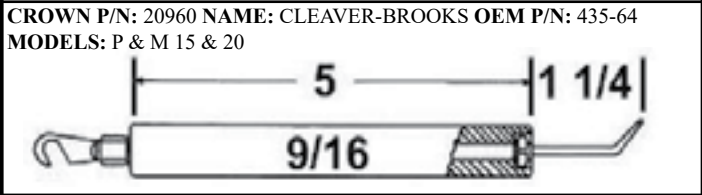
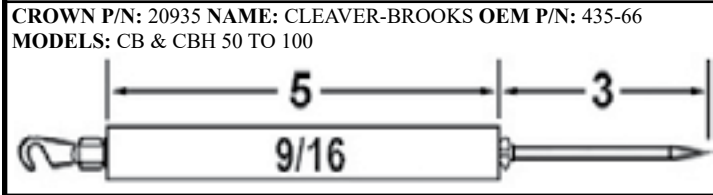
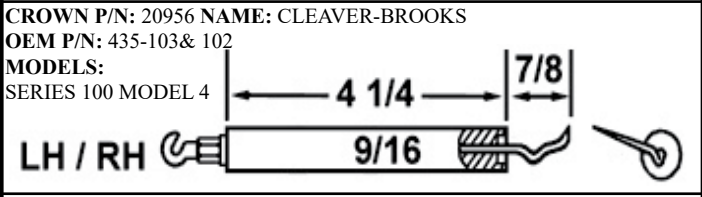
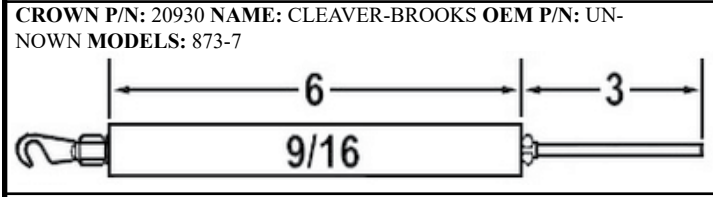
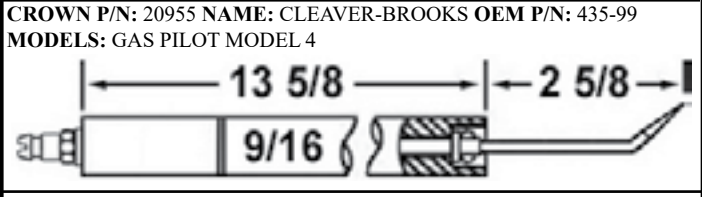
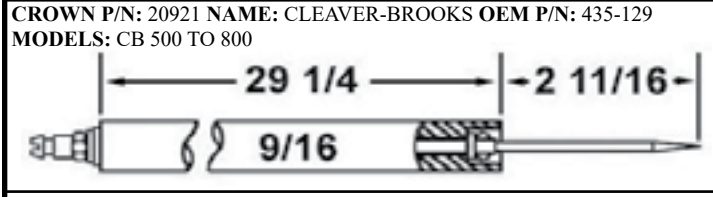
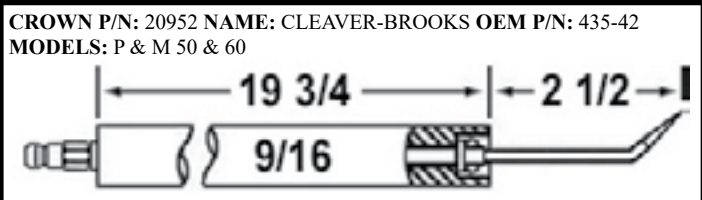
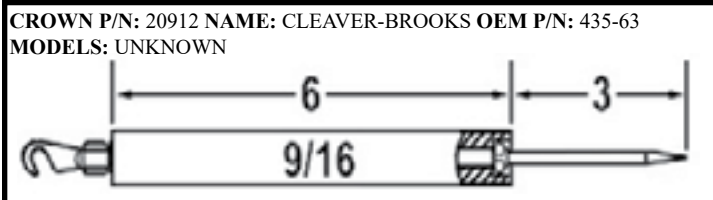



**Section 1: Electrodes**

**CROWN P/N: 20982 NAME: CLEAVER-BROOKS OEM P/N: 435-74**  
**MODELS: UNKNOWN**

**CROWN P/N: 21013 NAME: COLEMAN OEM P/N: 8870-420**  
**MODELS: UNKNOWN**

**CROWN P/N: 20984 NAME: CLEAVER-BROOKS OEM P/N: 435-78**  
**MODELS: UNKNOWN**

**CROWN P/N: 21025 NAME: COLUMBIA BOILER**  
**OEM P/N: UNKNOWN MODELS: UNKNOWN**

**CROWN P/N: 20986 NAME: CLEAVER-BROOKS OEM P/N: 435-52**  
**MODELS: UNKNOWN**

**CROWN P/N: 21046 NAME: COX OEM P/N: UNKNOWN**  
**MODELS: UNKNOWN**

**CROWN P/N: 20989 NAME: CLEAVER-BROOKS OEM P/N: 435-71**  
**MODELS: UNKNOWN**

**CROWN P/N: 21050 NAME: CRANE OEM P/N: UNKNOWN**  
**MODELS: CFR OIL BURNER**

**CROWN P/N: 20990 NAME: CLEAVER-BROOKS OEM P/N: 435-23**  
**MODELS: UNKNOWN**

**CROWN P/N: 21060 NAME: CROWN OEM P/N: UNKNOWN**  
**MODELS: UNKNOWN**

**CROWN P/N: 20992 NAME: CLEAVER-BROOKS OEM P/N: 435-11**  
**MODELS: CPT**

**CROWN P/N: 21065 NAME: CROWN OEM P/N: UNKNOWN**  
**MODELS: UNKNOWN**

**CROWN P/N: 20995 NAME: CLEAVER-BROOKS OEM P/N: 873-69**  
**MODELS: ALL 2-7**

**CROWN P/N: 21105 NAME: DELCO OEM P/N: UNKNOWN**  
**MODELS: UNKNOWN**

**CROWN P/N: 20996 NAME: CLEAVER-BROOKS OEM P/N: 873-70**  
**MODELS: AME & AMGE 5 & 60**

**CROWN P/N: 21115 NAME: DELCO OEM P/N: 509146**  
**MODELS: UNKNOWN**

**CROWN P/N: 21010 NAME: COLEMAN OEM P/N: 4070-410**  
**MODELS: UNKNOWN**

**CROWN P/N: 21155 NAME: DELCO OEM P/N: 5083431**  
**MODELS: UNKNOWN**



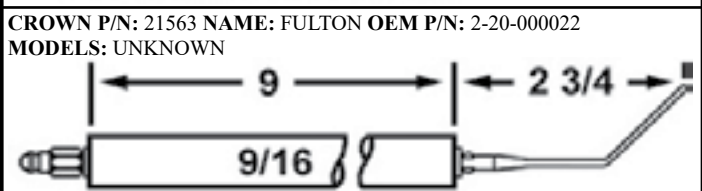
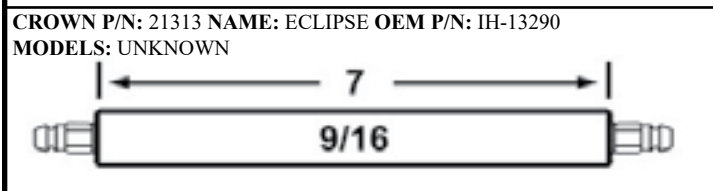
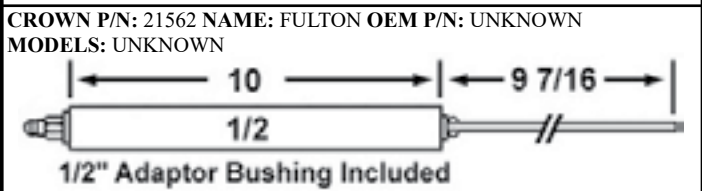
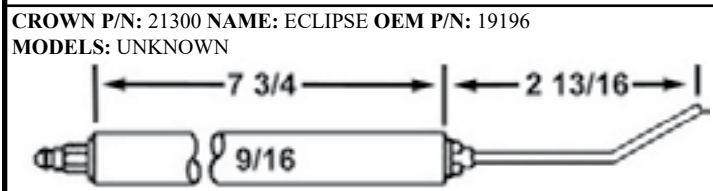
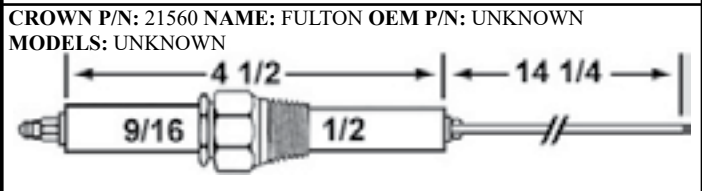
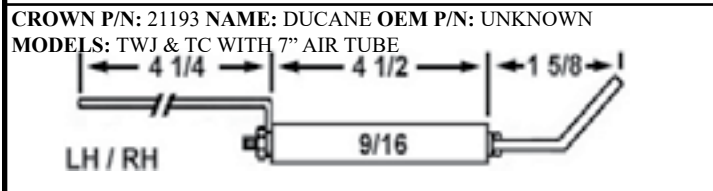
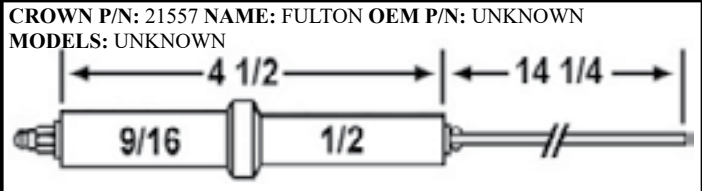
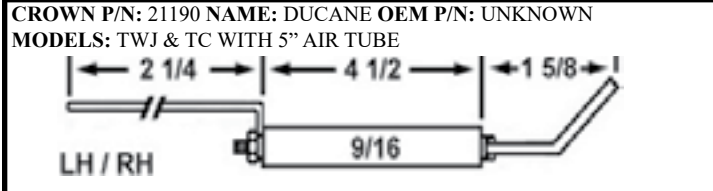
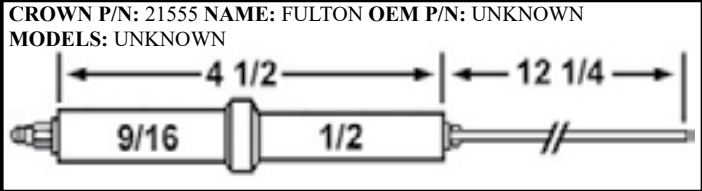
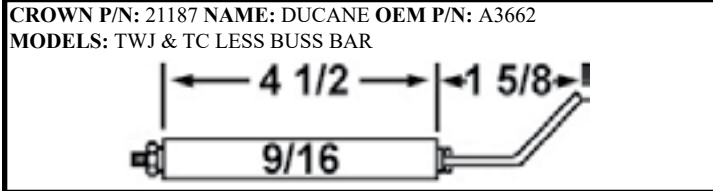
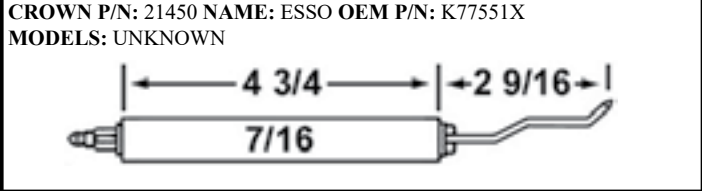
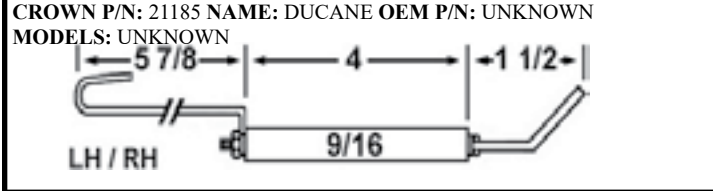
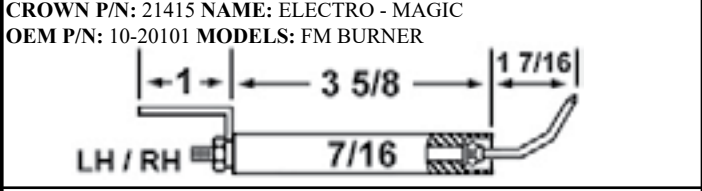
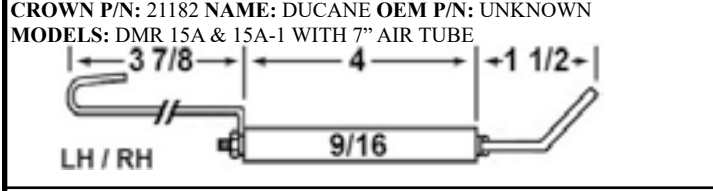
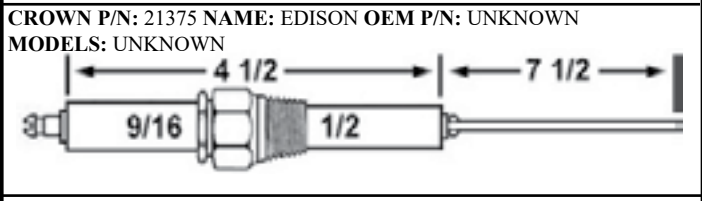
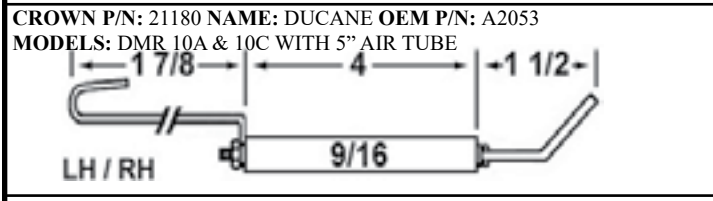
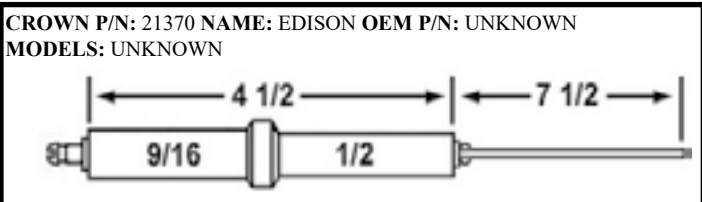
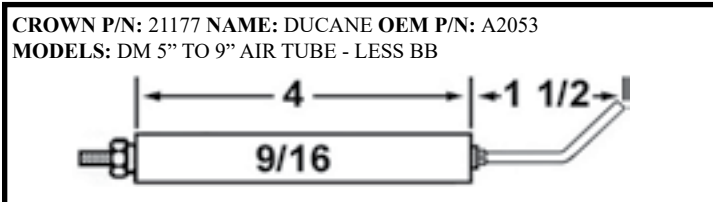



**Section 1: Electrodes**

<p><b>CROWN P/N:</b> 21565 <b>NAME:</b> FULTON <b>OEM P/N:</b> 2-20-000021  <b>MODELS:</b> UNKNOWN</p>	<p><b>CROWN P/N:</b> 21655 <b>NAME:</b> GENERAL OIL <b>OEM P/N:</b> UNKNOWN  <b>MODELS:</b> UNKNOWN</p>
<p><b>CROWN P/N:</b> 21566 <b>NAME:</b> FULTON <b>OEM P/N:</b> 2-20-000043  <b>MODELS:</b> A &amp; H</p>	<p><b>CROWN P/N:</b> 21672 <b>NAME:</b> GORDON - PIATT <b>OEM P/N:</b> 921000-3500  <b>MODELS:</b> GP-216C PILOT FOR 5 1/2" &amp; 8" AIR TUBE</p>
<p><b>CROWN P/N:</b> 21570 <b>NAME:</b> FULTON <b>OEM P/N:</b> 2-20-000054  <b>MODELS:</b> UNKNOWN</p>	<p><b>CROWN P/N:</b> 21674 <b>NAME:</b> GORDON - PIATT <b>OEM P/N:</b> 921000-3510  <b>MODELS:</b> GP-216C PILOT FOR 12" AIR TUBE</p>
<p><b>CROWN P/N:</b> 21571 <b>NAME:</b> FULTON <b>OEM P/N:</b> 2-20-000071  <b>MODELS:</b> UNKNOWN</p>	<p><b>CROWN P/N:</b> 21677 <b>NAME:</b> GORDON - PIATT <b>OEM P/N:</b> 210059-0000  <b>MODELS:</b> UNKNOWN</p>
<p><b>CROWN P/N:</b> 21573 <b>NAME:</b> FULTON <b>OEM P/N:</b> 2-20-000069  <b>MODELS:</b> UNKNOWN</p>	<p><b>CROWN P/N:</b> 21681 <b>NAME:</b> GORDON - PIATT <b>OEM P/N:</b> 210049-0000-50-0000  <b>MODELS:</b> RL &amp; RLS JACOBS</p>
<p><b>CROWN P/N:</b> 21610 <b>NAME:</b> GENERAL ELECTRIC  <b>OEM P/N:</b> K-5703668AB <b>MODELS:</b> UNKNOWN</p>	<p><b>CROWN P/N:</b> 21683 <b>NAME:</b> GORDON - PIATT  <b>OEM P/N:</b> UNKNOWN <b>MODELS:</b> F7T</p>
<p><b>CROWN P/N:</b> 21615 <b>NAME:</b> GENERAL ELECTRIC  <b>OEM P/N:</b> K-5703668AB <b>MODELS:</b> UNKNOWN</p>	<p><b>CROWN P/N:</b> 21687 <b>NAME:</b> GORDON - PIATT  <b>OEM P/N:</b> 280038 <b>MODELS:</b> 210036-1 FOR 4" AIR TUBE</p>
<p><b>CROWN P/N:</b> 21617 <b>NAME:</b> GENERAL ELECTRIC  <b>OEM P/N:</b> V-5700834AC <b>MODELS:</b> ASM</p>	<p><b>CROWN P/N:</b> 21689 <b>NAME:</b> GORDON - PIATT  <b>OEM P/N:</b> 210036-0003 <b>MODELS:</b> 210036-3/5 FOR 2" AIR TUBE</p>
<p><b>CROWN P/N:</b> 21625 <b>NAME:</b> GENERAL ELECTRIC  <b>OEM P/N:</b> K-5705183AD <b>MODELS:</b> UNKNOWN</p>	<p><b>CROWN P/N:</b> 21690 <b>NAME:</b> GORDON - PIATT  <b>OEM P/N:</b> 210036-0002 <b>MODELS:</b> 210036-2 FOR 8" AIR TUBE</p>

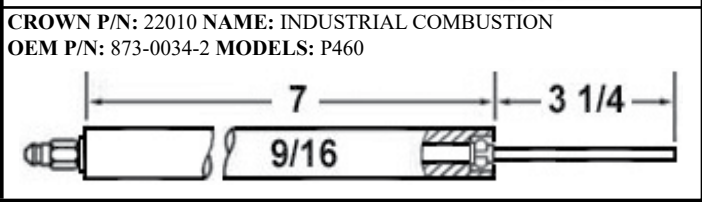
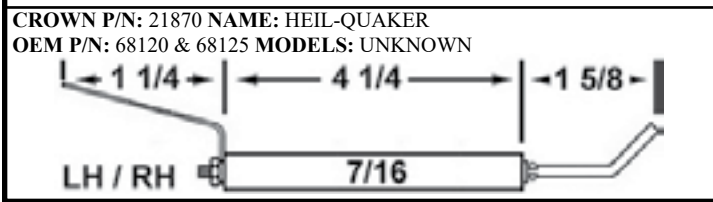
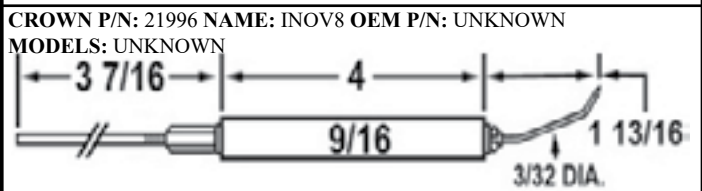
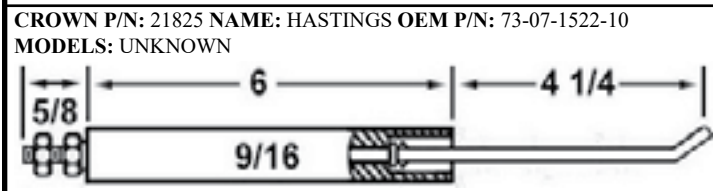
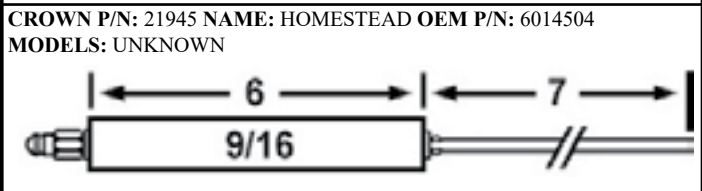
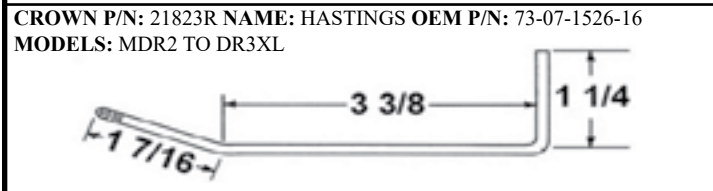
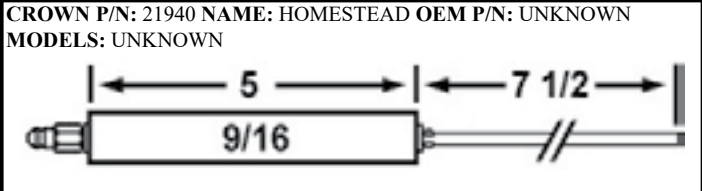
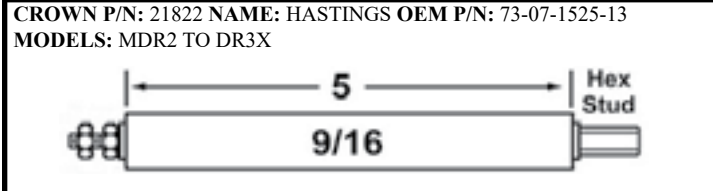
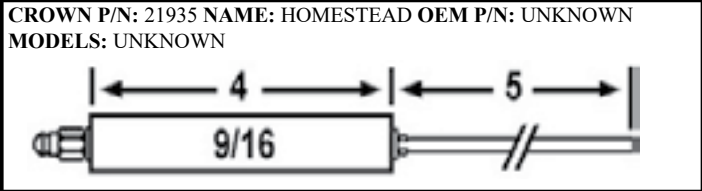
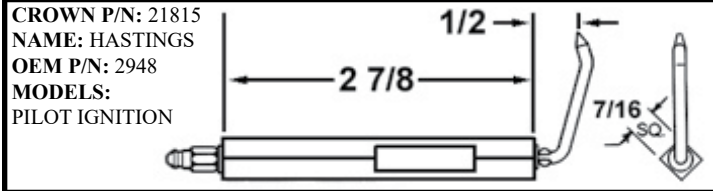
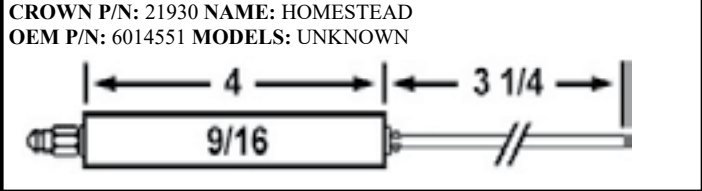
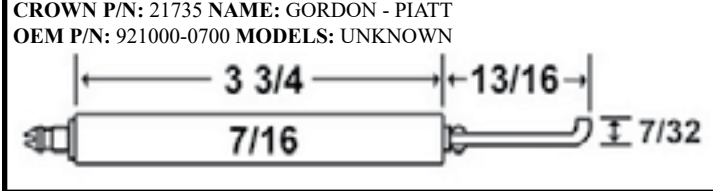
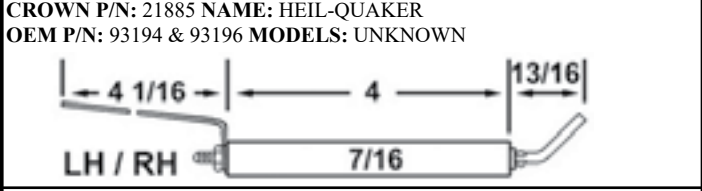
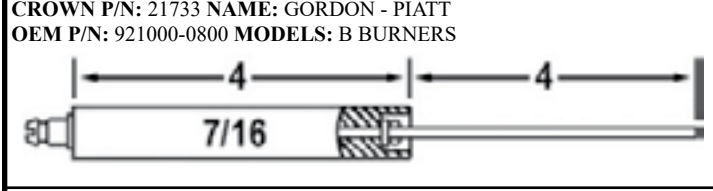
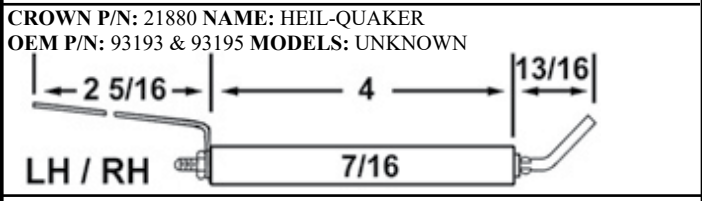
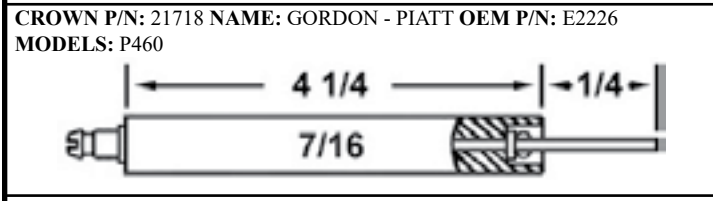
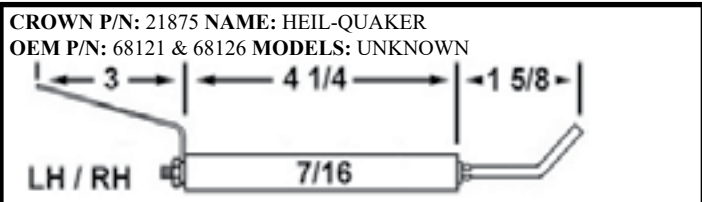
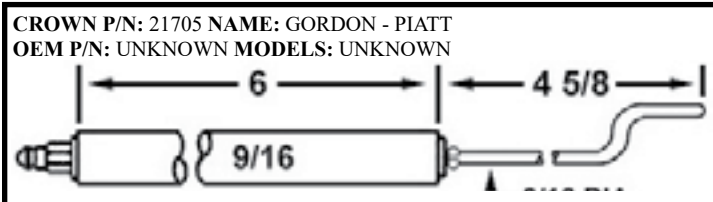





**CROWN P/N:** 22013-01 **NAME:** INDUSTRIAL COMBUSTION  
**OEM P/N:** 873-108  
**MODELS:** CB PROFIRE #1 & #2. D & MARC

INCLUDES SPURT WELD KIT  
 FOR BURNER ASSEMBLY

**CROWN P/N:** 22083  
**NAME:** IRON FIREMAN  
**OEM P/N:** 135161 & 135162  
**MODELS:** UNKNOWN

LH / RH

**CROWN P/N:** 22015 **NAME:** INDUSTRIAL COMBUSTION  
**OEM P/N:** 873-501-2 **MODELS:** SC 55 & 65

**CROWN P/N:** 22087 **NAME:** IRON FIREMAN **OEM P/N:** 134259 & 34260 **MODELS:** UNKNOWN

LH / RH

**CROWN P/N:** 22016 **NAME:** INDUSTRIAL COMBUSTION  
**OEM P/N:** 873-76-2 **MODELS:** SC-55 FLAME ROD

3/16 DIA. ROD

**CROWN P/N:** 22088  
**NAME:** IRON FIREMAN  
**OEM P/N:** 141833 & 141834  
**MODELS:** UNKNOWN

LH / RH

**CROWN P/N:** 22017 **NAME:** INDUSTRIAL COMBUSTION  
**OEM P/N:** 873-508  
**MODELS:** D SERIES 28-300, FG, FMG, FGL, & FMGL

**CROWN P/N:** 22090 **NAME:** IRON FIREMAN  
**OEM P/N:** 136159 & 136160 **MODELS:** UNKNOWN

LH / RH

**CROWN P/N:** 22020 **NAME:** INDUSTRIAL COMBUSTION  
**OEM P/N:** 873-0092-00 **MODELS:** FP & MP BURNERS

**REPLACED BY P/N: XX1597**

**CROWN P/N:** 22092  
**NAME:** IRON FIREMAN  
**OEM P/N:** 149280-G01  
**MODELS:** UNKNOWN

11/16

**CROWN P/N:** 22021 **NAME:** INDUSTRIAL COMBUSTION  
**OEM P/N:** 873-0087-00 **MODELS:** D & MARC BURNERS

3/32 DIA.

**CROWN P/N:** 22095 **NAME:** IRON FIREMAN **OEM P/N:** 149280-G02  
**MODELS:** UNKNOWN

1 1/32

**CROWN P/N:** 22025  
**NAME:** INTERBURNER  
**OEM P/N:** 26950  
**MODELS:** UNKNOWN

.12 GAP  
 .43

**CROWN P/N:** 22098 **NAME:** IRON FIREMAN **OEM P/N:** 149281-G01  
**MODELS:** UNKNOWN

11/16

**CROWN P/N:** 22046 **NAME:** IRON FIREMAN **OEM P/N:** 149280-G03  
**MODELS:** UNKNOWN

3/4

**CROWN P/N:** 22105 **NAME:** IRON FIREMAN **OEM P/N:** 137555  
**MODELS:** AO 142059

5/8

**CROWN P/N:** 22070 **NAME:** IRON FIREMAN **OEM P/N:** UNKNOWN  
**MODELS:** UNKNOWN

LH / RH

**CROWN P/N:** 22115 **NAME:** IRON FIREMAN **OEM P/N:** 137161  
**MODELS:** UNKNOWN

2

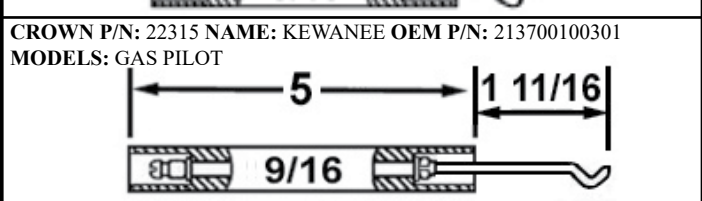
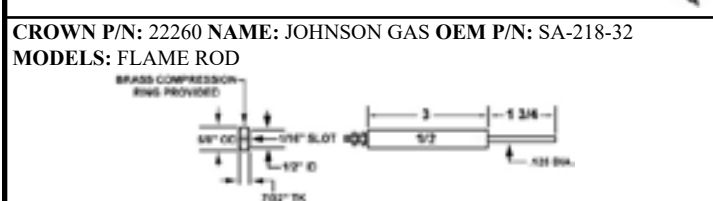
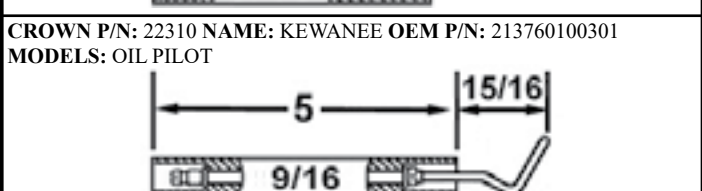
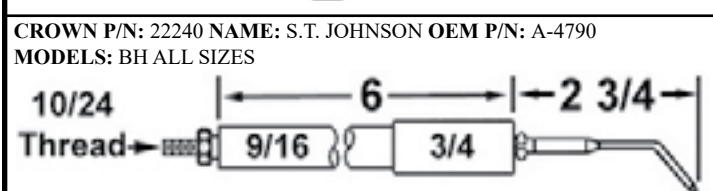
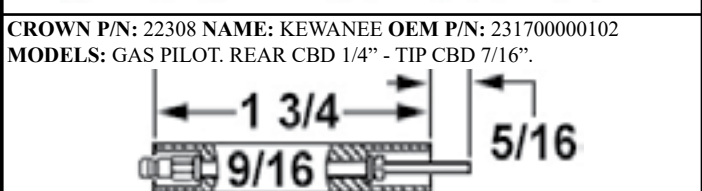
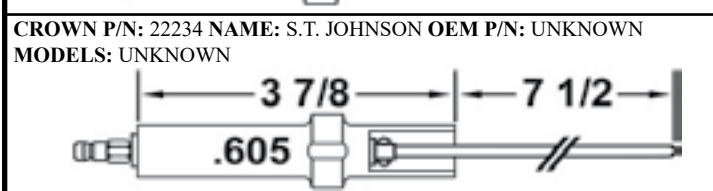
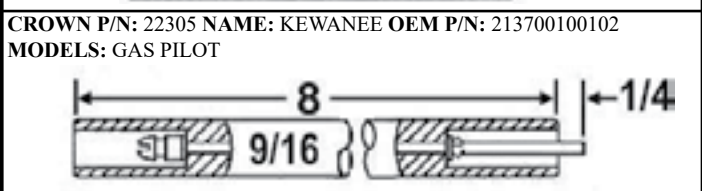
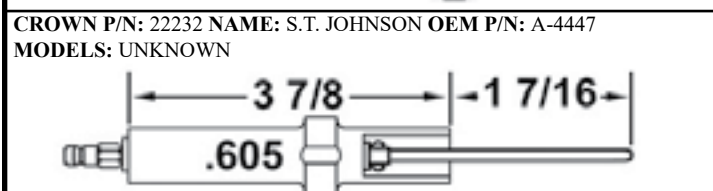
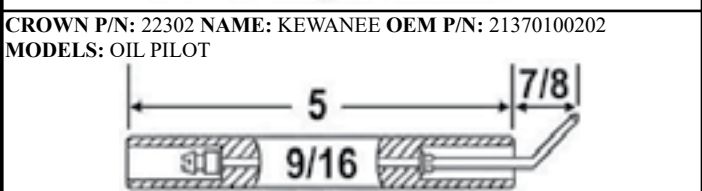
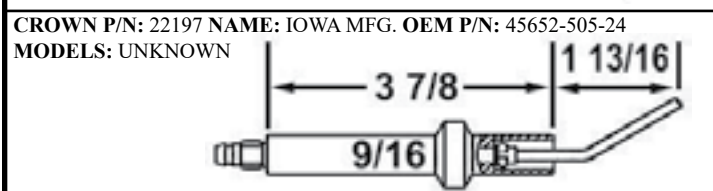
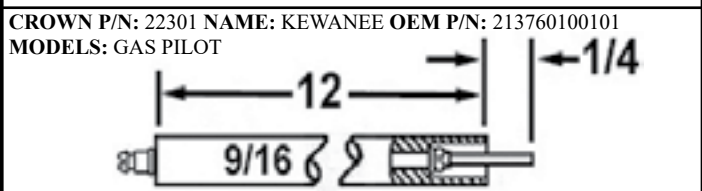
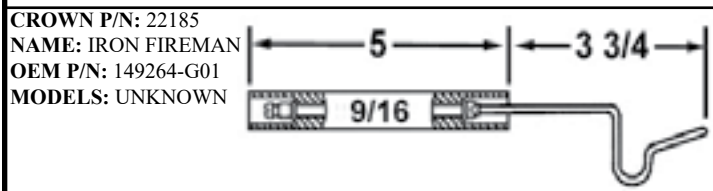
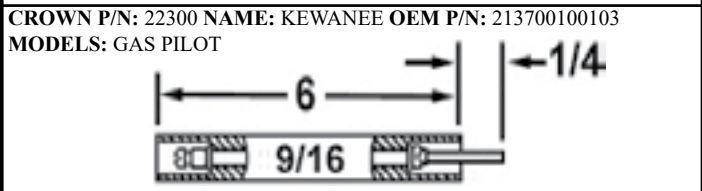
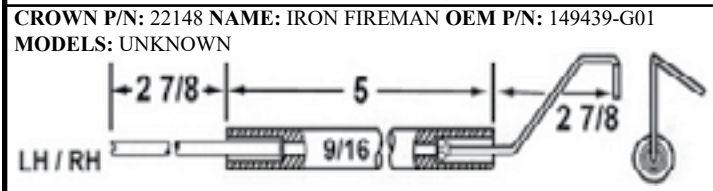
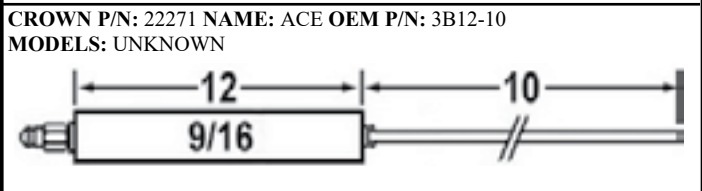
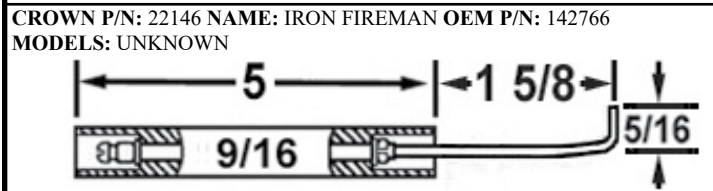
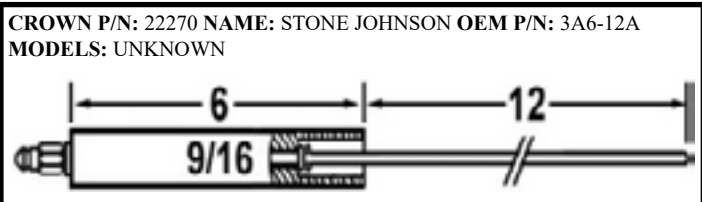
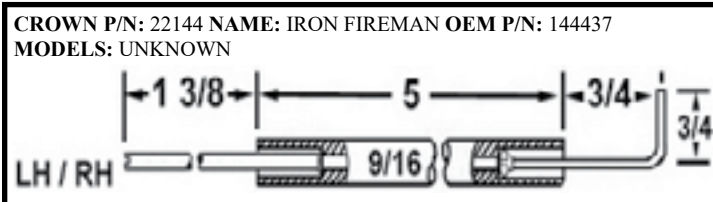



**Section 1: Electrodes**

**CROWN P/N:** 22316 **NAME:** KEWANEE **OEM P/N:** 213790070901  
**MODELS:** 2 TO 5 BURNER

**CROWN P/N:** 22428 **NAME:** LENNOX **OEM P/N:** 51A9401 & 301  
**MODELS:** UNKNOWN

**CROWN P/N:** 22317 **NAME:** KEWANEE **OEM P/N:** 213790070902  
**MODELS:** 6 & 7 BURNER

**CROWN P/N:** 22429 **NAME:** LENNOX **OEM P/N:** P-8-5798  
**MODELS:** GAS BUSS ROD

**CROWN P/N:** 22320 **NAME:** KEWANEE **OEM P/N:** 950525-2  
**MODELS:** UNKNOWN

**CROWN P/N:** 22434 **NAME:** LENNOX **OEM P/N:** 77C8301  
**MODELS:** SENSOR

**CROWN P/N:** 22326 **NAME:** KEWANEE **OEM P/N:** 309200000002  
**MODELS:** UNKNOWN

**CROWN P/N:** 22435 **NAME:** LENNOX **OEM P/N:** 77C8201  
**MODELS:** IGNITER

**CROWN P/N:** 22407 **NAME:** LANDA **OEM P/N:** 7-9005  
**MODELS:** UNKNOWN

**CROWN P/N:** 22463 **NAME:** LOCHINVAR **OEM P/N:** RLY-2705  
**MODELS:** POWER FIN - .250 X .031 MALE QUICK CONNECT TAB.

**CROWN P/N:** 22408 **NAME:** LANAIR **OEM P/N:** 8737 & 8738  
**MODELS:** UNKNOWN

**CROWN P/N:** 22480 **NAME:** LYNN **OEM P/N:** UNKNOWN  
**MODELS:** UNKNOWN

**CROWN P/N:** 22409 **NAME:** LANAIR **OEM P/N:** 8945 & 8944  
**MODELS:** UNKNOWN

**CROWN P/N:** 25005 **NAME:** McQUAY **OEM P/N:** 357410-A-00  
**MODELS:** UNKNOWN

**CROWN P/N:** 22426 **NAME:** LENNOX **OEM P/N:** P-8-7038  
**MODELS:** UNKNOWN

**CROWN P/N:** 25006 **NAME:** McQUAY **OEM P/N:** 365577-A-00  
**MODELS:** UNKNOWN

**CROWN P/N:** 22427 **NAME:** LENNOX **OEM P/N:** P-8-5784  
**MODELS:** UNKNOWN

**CROWN P/N:** 25025 **NAME:** MALSBARO **OEM P/N:** 821669  
**MODELS:** UNKNOWN





<p><b>CROWN P/N:</b> 25045 <b>NAME:</b> MARSDEN <b>OEM P/N:</b> 179118  <b>MODELS:</b> UNKNOWN</p>	<p><b>CROWN P/N:</b> 25150 <b>NAME:</b> MIDCO <b>OEM P/N:</b> 1341-00  <b>MODELS:</b> ADAPTO PILOT FLAME ROD</p>
<p><b>CROWN P/N:</b> 25047 <b>NAME:</b> MARSDEN <b>OEM P/N:</b> 25047-F3  <b>MODELS:</b> UNKNOWN</p>	<p><b>CROWN P/N:</b> 25151 <b>NAME:</b> MIDCO <b>OEM P/N:</b> UNKNOWN  <b>MODELS:</b> ADAPTO PILOT FLAME ROD</p>
<p><b>CROWN P/N:</b> 25052 <b>NAME:</b> MASTER VIBRATOR  <b>OEM P/N:</b> M-8989 &amp; 8990  <b>MODELS:</b> UNKNOWN</p>	<p><b>CROWN P/N:</b> 25152 <b>NAME:</b> MIDCO <b>OEM P/N:</b> 1342-00  <b>MODELS:</b> PILOT SPARK ROD FOR HMA 1 &amp; 2 BURNERS</p>
<p><b>CROWN P/N:</b> 25054 <b>NAME:</b> MASTER VIBRATOR  <b>OEM P/N:</b> M-12951 &amp; 12952  <b>MODELS:</b> BB HEATER          64-65 120MBTU</p>	<p><b>CROWN P/N:</b> 25156 <b>NAME:</b> MIDCO <b>OEM P/N:</b> 5234-50  <b>MODELS:</b> FLAME ROD FOR ECONOMITE 400 SERIES BURNERS</p>
<p><b>CROWN P/N:</b> 25058  <b>NAME:</b> MASTER VIBRATOR  <b>OEM P/N:</b> M3987 REV H  <b>MODELS:</b> HIGH PRESSURE HEATERS</p>	<p><b>CROWN P/N:</b> 25158 <b>NAME:</b> MIDCO <b>OEM P/N:</b> 5249-32  <b>MODELS:</b> IGNITER FOR ECONOMITE 400 SERIES BURNERS</p>
<p><b>CROWN P/N:</b> 25060  <b>NAME:</b> MASTER VIBRATOR  <b>OEM P/N:</b> M3987 REV J  <b>MODELS:</b> HIGH PRESSURE HEATERS</p>	<p><b>CROWN P/N:</b> 25168 <b>NAME:</b> MIDCO <b>OEM P/N:</b> 6430-00  <b>MODELS:</b> JDS ELECTRODE</p>
<p><b>CROWN P/N:</b> 25095 <b>NAME:</b> METAL MASTER <b>OEM P/N:</b> A-1031-217  <b>MODELS:</b> UNKNOWN</p>	<p><b>CROWN P/N:</b> 25177 <b>NAME:</b> MIDCO <b>OEM P/N:</b> 6725-50  <b>MODELS:</b> UNIMITE SPARK ROD</p>
<p><b>CROWN P/N:</b> 25107 <b>NAME:</b> METAL MASTER <b>OEM P/N:</b> UNKNOWN  <b>MODELS:</b> UNKNOWN</p>	<p><b>CROWN P/N:</b> 25180 <b>NAME:</b> MIDCO <b>OEM P/N:</b> 7171-00  <b>MODELS:</b> UNKNOWN</p>
<p><b>CROWN P/N:</b> 25149 <b>NAME:</b> MIDCO <b>OEM P/N:</b> 1360-03  <b>MODELS:</b> FLAME ROD FOR HMA 1 &amp; 2 BURNERS USED WITH 25152</p>	<p><b>CROWN P/N:</b> 25184 <b>NAME:</b> MIDCO <b>OEM P/N:</b> 6011-20  <b>MODELS:</b> 232 SPARK ROD ASSEMBLY</p>



**Section 1: Electrodes**

**CROWN P/N:** 25190 **NAME:** MIDCO **OEM P/N:** 3713-71  
**MODELS:** NHL PILOT

**CROWN P/N:** 25218 **NAME:** M. HONEYWELL  
**OEM P/N:** UNKNOWN **MODELS:** UNKNOWN

**CROWN P/N:** 25193 **OEM NAME:** MIDCO **OEM P/N:** 7124-40  
**MODELS:** AG FLAME ROD

**CROWN P/N:** 25220 **NAME:** M. HONEYWELL  
**OEM P/N:** UNKNOWN **MODELS:** UNKNOWN

**CROWN P/N:** 35161 **OEM NAME:** MIDCO **OEM P/N:** 6457-00  
**MODELS:** J82 / 83-DS

**CROWN P/N:** 25221 **NAME:** M. HONEYWELL  
**OEM P/N:** UNKNOWN **MODELS:** UNKNOWN

**CROWN P/N:** 35192 **NAME:** MIDCO **OEM P/N:** 6717-00  
**MODELS:** UNKNOWN

**CROWN P/N:** 25222 **NAME:** M. HONEYWELL  
**OEM P/N:** UNKNOWN **MODELS:** UNKNOWN

**CROWN P/N:** 35199 **NAME:** MIDCO **OEM P/N:** 6418-00  
**MODELS:** J82 / 83-DS

**CROWN P/N:** 25210 **NAME:** MILLER **OEM P/N:** E-1622-B  
**MODELS:** USED ON H-3512-A

**CROWN P/N:** 25226 **NAME:** M. HONEYWELL  
**OEM P/N:** UNKNOWN **MODELS:** ADAPTO PILOT SPARK ROD

**CROWN P/N:** 25212 **NAME:** MILLER **OEM P/N:** 308-0550  
**MODELS:** FS MODEL

**CROWN P/N:** 25215 **NAME:** M. HONEYWELL  
**OEM P/N:** UNKNOWN **MODELS:** UNKNOWN

**CROWN P/N:** 25230  
**NAME:** M. HONEYWELL  
**OEM P/N:** UNKNOWN **MODELS:** UNKNOWN

**CROWN P/N:** 25216  
**NAME:** M. HONEYWELL  
**OEM P/N:** UNKNOWN **MODELS:** UNKNOWN

**CROWN P/N:** 25412 **NAME:** NATIONAL AIROIL  
**OEM P/N:** UNKNOWN **MODELS:** UNKNOWN

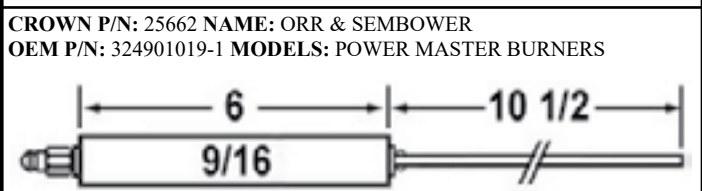
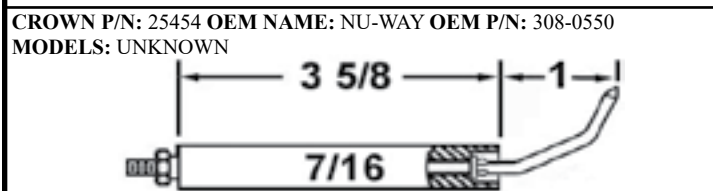
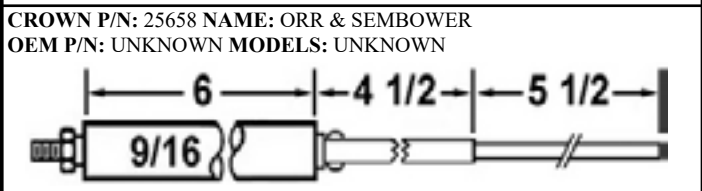
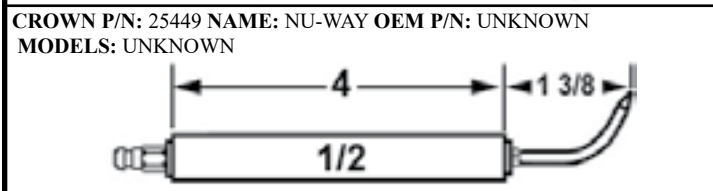
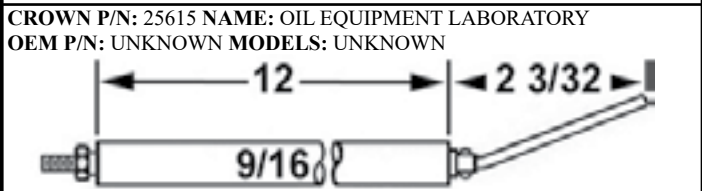
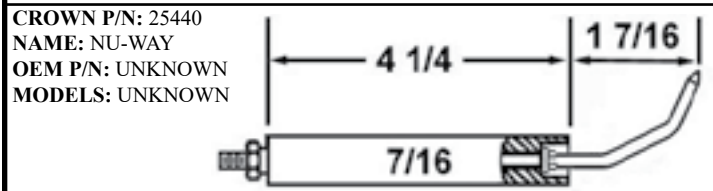
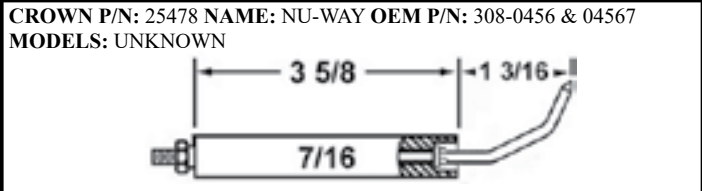
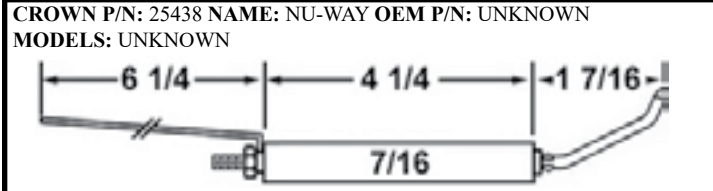
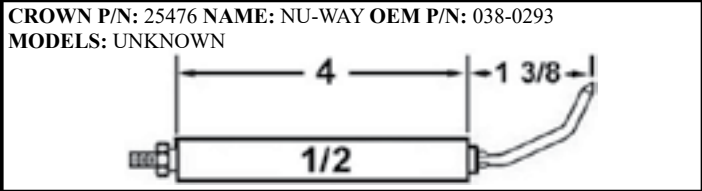
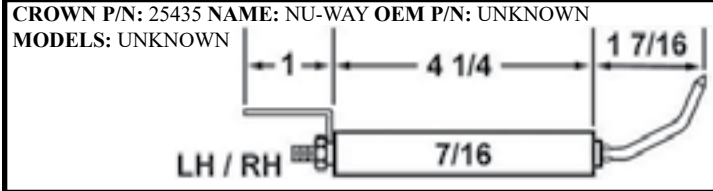
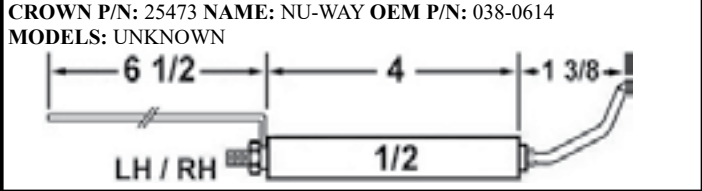
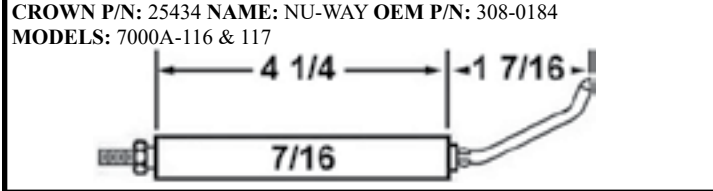
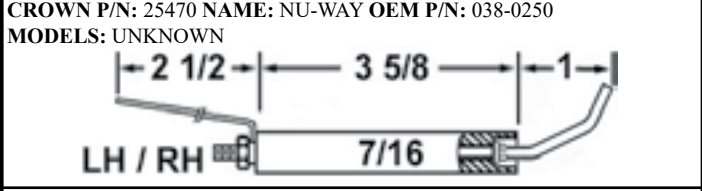
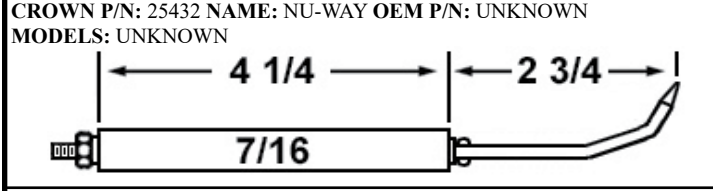
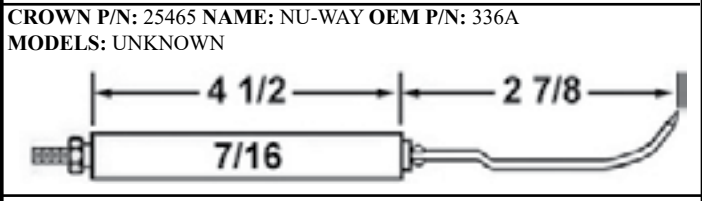
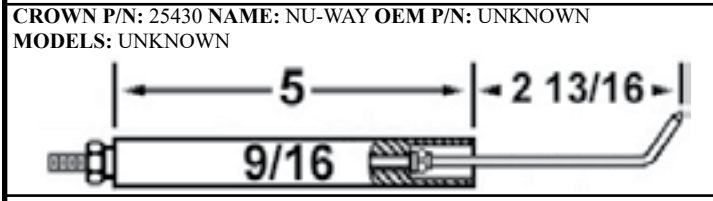
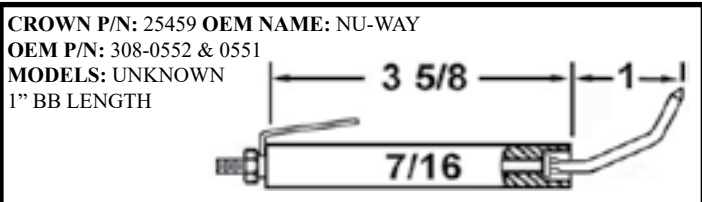
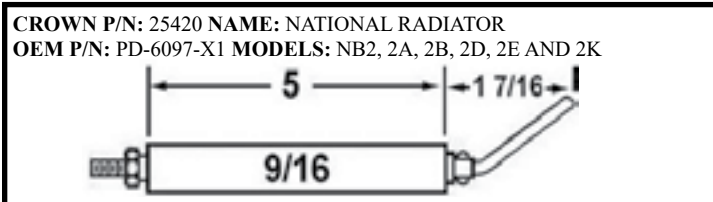





**Section 1: Electrodes**

**CROWN P/N: 26000 NAME: MILLER (L.S.I.) OEM P/N: 102823000**  
**MODELS: UNKNOWN**

**CROWN P/N: 26782 NAME: PVI INDUSTRIES OEM P/N: 08381**  
**MODELS: ALL GAS**

**CROWN P/N: 26005 NAME: MILLER (L.S.I.) OEM P/N: 102835000**  
**MODELS: UNKNOWN**

**CROWN P/N: 26785 NAME: PVI INDUSTRIES OEM P/N: 71906**  
**MODELS: ALL GAS**

**CROWN P/N: 26010 NAME: MILLER (L.S.I.) OEM P/N: 102836000**  
**MODELS: UNKNOWN**

**CROWN P/N: 26796 NAME: PATTERSON-KELLY**  
**OEM P/N: B90549/86-2450-0820 MODELS: N-700 THRU N-2000**

**CROWN P/N: 26020 NAME: MILLER (L.S.I.) OEM P/N: 102839000**  
**MODELS: UNKNOWN**

**CROWN P/N: 26798 NAME: PATTERSON-KELLY**  
**OEM P/N: B89399/86-7100-0230 MODELS: N-700 THRU N-2000**

**CROWN P/N: 26025 NAME: MILLER (L.S.I.) OEM P/N: 102840000**  
**MODELS: UNKNOWN**

**CROWN P/N: 26805 NAME: PEABODY ENGINEERING**  
**OEM P/N: E-38646-F MODELS: UNKNOWN**

**CROWN P/N: 26030 NAME: MILLER (L.S.I.) OEM P/N: 102841000**  
**MODELS: UNKNOWN**

**CROWN P/N: 26808 NAME: PEABODY ENGINEERING**  
**OEM P/N: E-38647-D MODELS: UNKNOWN**

**CROWN P/N: 26035 NAME: MILLER (L.S.I.) OEM P/N: 104165000**  
**MODELS: UNKNOWN**

**CROWN P/N: 26840 NAME: PETRO OEM P/N: UNKNOWN**  
**MODELS: UNKNOWN**

**CROWN P/N: 26040 NAME: MILLER (L.S.I.) OEM P/N: 104003000**  
**MODELS: UNKNOWN**

**CROWN P/N: 26848 NAME: PETRO OEM P/N: UNKNOWN**  
**MODELS: UNKNOWN**

**CROWN P/N: 26780 NAME: PVI INDUSTRIES OEM P/N: 71907**  
**MODELS: ALL GAS**

**CROWN P/N: 26850 NAME: PETRO OEM P/N: UNKNOWN**  
**MODELS: UNKNOWN**



**CROWN P/N:** 26856 **NAME:** PETRO **OEM P/N:** C114049  
**MODELS:** UNKNOWN

**CROWN P/N:** 26878 **NAME:** POWERFLAME **OEM P/N:** UNKNOWN  
**MODELS:** UNKNOWN

**CROWN P/N:** 26859 **NAME:** PETRO **OEM P/N:** UNKNOWN  
**MODELS:** UNKNOWN

**CROWN P/N:** 26880 **NAME:** POWERFLAME **OEM P/N:** M775  
**MODELS:** FGO & FM-1 IGNITOR

**CROWN P/N:** 26860 **NAME:** PETRO **OEM P/N:** UNKNOWN  
**MODELS:** W1 TO W10

**CROWN P/N:** 26882 **NAME:** POWERFLAME **OEM P/N:** M775  
**MODELS:** FGO & FM-1 GAS PILOT

**CROWN P/N:** 26865 **NAME:** PETRO **OEM P/N:** UNKNOWN  
**MODELS:** UNKNOWN

**CROWN P/N:** 26884 **NAME:** POWERFLAME **OEM P/N:** M-775  
**MODELS:** FGO-FM-1 GAS PILOT

**CROWN P/N:** 26866 **NAME:** PETRO **OEM P/N:** UNKNOWN  
**MODELS:** UNKNOWN

**CROWN P/N:** 26887 **NAME:** POWERFLAME **OEM P/N:** X04210  
**MODELS:** C, J, & CG

**CROWN P/N:** 26867 **NAME:** PETRO **OEM P/N:** UNKNOWN  
**MODELS:** UNKNOWN

**CROWN P/N:** 26888 **NAME:** POWERFLAME **OEM P/N:** UNKNOWN  
**MODELS:** UNKNOWN

**CROWN P/N:** 26871 **NAME:** POWERFLAME **OEM P/N:** 30D39-3 & 38-3  
**MODELS:** UNKNOWN

**CROWN P/N:** 26890 **NAME:** POWERFLAME **OEM P/N:** UNKNOWN  
**MODELS:** C, J, & CG

**CROWN P/N:** 26875 **NAME:** POWERFLAME **OEM P/N:** 126036  
**MODELS:** P-90

**CROWN P/N:** 26892 **NAME:** POWERFLAME **OEM P/N:** X04248  
**MODELS:** UNKNOWN

**CROWN P/N:** 26876 **NAME:** POWERFLAME **OEM P/N:** UNKNOWN  
**MODELS:** UNKNOWN

**CROWN P/N:** 26893 **NAME:** POWERFLAME **OEM P/N:** X04220  
**MODELS:** C2,C3, & C4 OIL BURNERS



**Section 1: Electrodes**

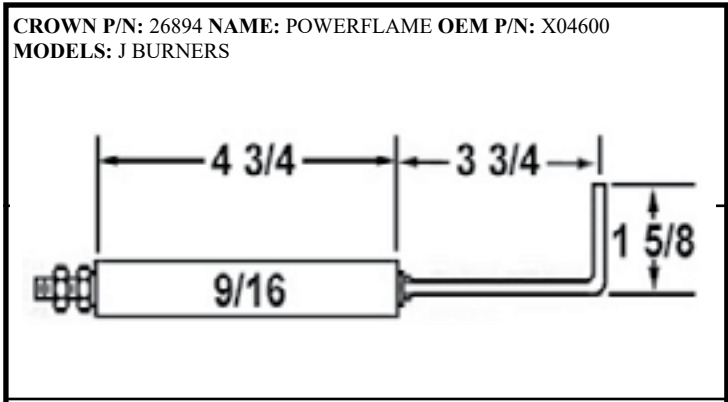

THIS SPACE LEFT BLANK INTENTIONALLY

THIS SPACE LEFT BLANK INTENTIONALLY

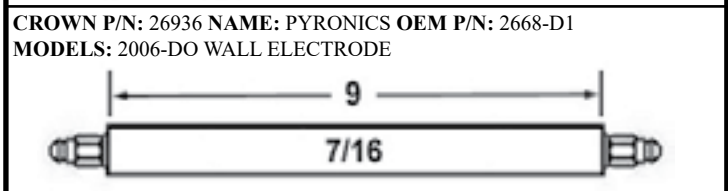
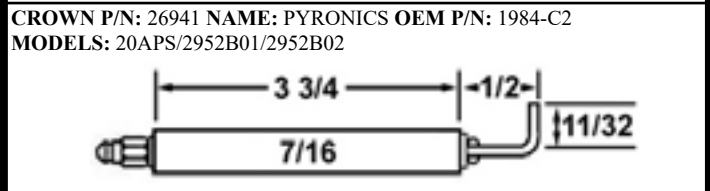
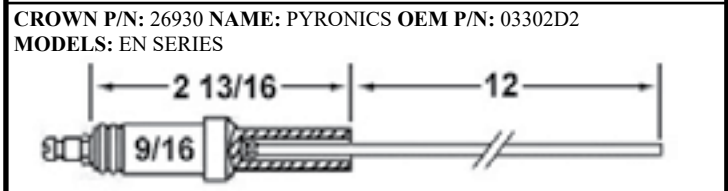
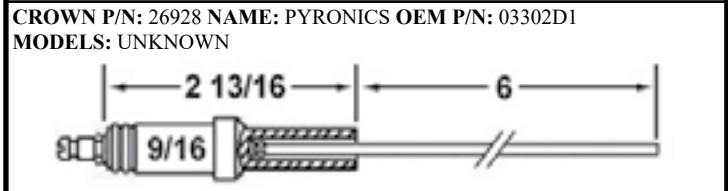
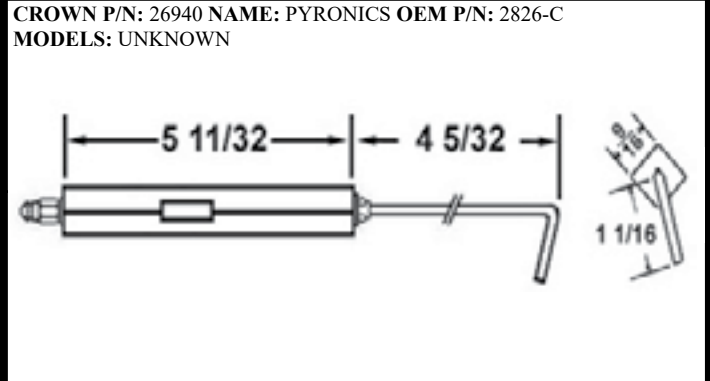
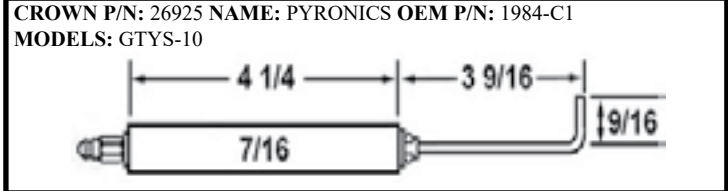
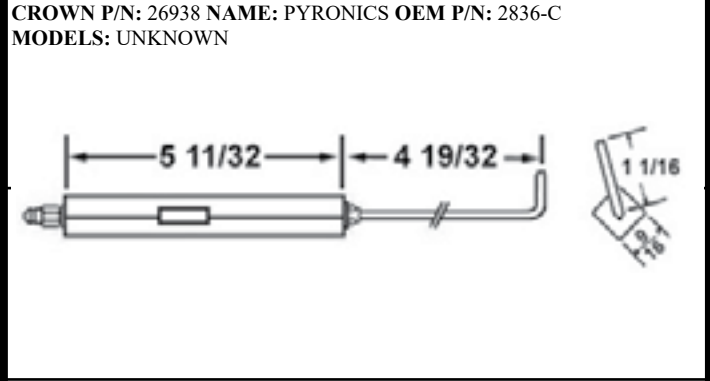
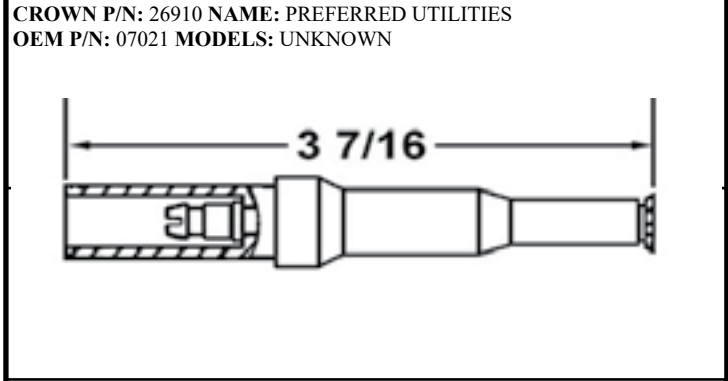

THIS SPACE LEFT BLANK INTENTIONALLY

THIS SPACE LEFT BLANK INTENTIONALLY

THIS SPACE LEFT BLANK INTENTIONALLY





**CROWN P/N:** 26942 **NAME:** PYRONICS **OEM P/N:** 1984-C3  
**MODELS:** 2952B01 & 02

**CROWN P/N:** 27170R  
**NAME:** RAY OIL BURNER  
**OEM P/N:** 50485  
**MODELS:** PG, PGF, & MODEL 55

**CROWN P/N:** 27005 **NAME:** QUIET AUTOMATIC  
**OEM P/N:** UNKNOWN **MODELS:** UNKNOWN

**CROWN P/N:** 27172R  
**NAME:** RAY OIL BURNER  
**OEM P/N:** 51700  
**MODELS:** P BURNERS

**CROWN P/N:** 27030 **NAME:** QUIET AUTOMATIC  
**OEM P/N:** UNKNOWN **MODELS:** UNKNOWN

**CROWN P/N:** 27250 **NAME:** ROSOEE **OEM P/N:** UNKNOWN  
**MODELS:** UNKNOWN

**CROWN P/N:** 27040 **NAME:** QUIET HEAT **OEM P/N:** E60601  
**MODELS:** C100, 215, 265, 335, & D215, 319

**CROWN P/N:** 27321 **NAME:** SHELL HEAD  
**OEM P/N:** UNKNOWN **MODELS:** UNKNOWN

**CROWN P/N:** 27126 **NAME:** RAY OIL BURNER  
**OEM P/N:** 8214-1 **MODELS:** UNKNOWN

**CROWN P/N:** 27324 **NAME:** SHELL HEAD  
**OEM P/N:** UNKNOWN **MODELS:** UNKNOWN

**CROWN P/N:** 27132 **NAME:** RAY OIL BURNER  
**OEM P/N:** 8234-1 **MODELS:** 0-8 BOTTLED GAS

**CROWN P/N:** 27340 **NAME:** SHELL HEAD  
**OEM P/N:** UNKNOWN **MODELS:** UNKNOWN

**CROWN P/N:** 27140 **NAME:** RAY OIL BURNER  
**OEM P/N:** 51276-1 **MODELS:** JPE BURNER

**CROWN P/N:** 27342 **NAME:** SHELL HEAD  
**OEM P/N:** UNKNOWN **MODELS:** UNKNOWN

**CROWN P/N:** 27145 **NAME:** RAY OIL BURNER  
**OEM P/N:** 51703-1  
**MODELS:** P BURNER

**CROWN P/N:** 27353 **NAME:** SHENANDOAH  
**OEM P/N:** 10155320 & 40 **MODELS:** WO-F

**CROWN P/N:** 27166 **NAME:** RAY OIL BURNER **OEM P/N:** 54110  
**MODELS:** AE 350-700



**Section 1: Electrodes**

<p><b>CROWN P/N: 27380 NAME: SILENT GLOW</b>  <b>OEM P/N: 36200 MODELS: UNKNOWN</b></p>	<p><b>CROWN P/N: 27493 NAME: SUNRAY OEM P/N: UNKNOWN</b>  <b>MODELS: UNKNOWN</b></p>
<p><b>CROWN P/N: 27384 NAME: SILENT GLOW</b>  <b>OEM P/N: UNKNOWN MODELS: UNKNOWN</b></p>	<p><b>CROWN P/N: 27498 NAME: SUNRAY OEM P/N: E40351</b>  <b>MODELS: HC, PHC, R, MR, PR / PMR 863 &amp; 9833</b></p>
<p><b>CROWN P/N: 27386 NAME: SILENT GLOW</b>  <b>OEM P/N: UNKNOWN MODELS: UNKNOWN</b></p>	<p><b>CROWN P/N: 27500 NAME: SUNRAY OEM P/N: E40393</b>  <b>MODELS: DC, GC, LC, GE, &amp; PGC</b></p>
<p><b>CROWN P/N: 27388 NAME: SILENT GLOW OEM P/N: UNKNOWN</b>  <b>MODELS: UNKNOWN</b></p>	<p><b>CROWN P/N: 27516 NAME: SUNRAY OEM P/N: E41211</b>  <b>MODELS: SHELL CONVERSION KIT</b></p>
<p><b>CROWN P/N: 27451 NAME: STEWART WARNER</b>  <b>OEM P/N: 735062 MODELS: UNKNOWN</b></p>	<p><b>CROWN P/N: 27518 NAME: SUNRAY OEM P/N: UNKNOWN</b>  <b>MODELS: UNKNOWN</b></p>
<p><b>CROWN P/N: 27452 NAME: STEWART WARNER</b>  <b>OEM P/N: 6A-170054 MODELS: UNKNOWN</b></p>	<p><b>CROWN P/N: 27520 NAME: SUNRAY OEM P/N: UNKNOWN</b>  <b>MODELS: UNKNOWN</b></p>
<p><b>CROWN P/N: 27480 NAME: SUNRAY OEM P/N: UNKNOWN</b>  <b>MODELS: UNKNOWN</b></p>	<p><b>CROWN P/N: 27522 NAME: SUNRAY OEM P/N: EA46142-2 &amp; 3</b>  <b>MODELS: OE-1 BURNER</b></p>
<p><b>CROWN P/N: 27490</b>  <b>NAME: SUNRAY</b>  <b>OEM P/N: UNKNOWN</b>  <b>MODELS: UNKNOWN</b></p>	<p><b>CROWN P/N: 27534 NAME: SUPERIOR BOILER</b>  <b>OEM P/N: UNKNOWN MODELS: UNKNOWN</b></p>
<p><b>CROWN P/N: 27492</b>  <b>NAME: SUNRAY</b>  <b>OEM P/N: E40491</b>  <b>MODELS: ICA, D2, D3 &amp; G</b></p>	<p><b>CROWN P/N: 27536 NAME: SUPERIOR BOILER</b>  <b>OEM P/N: UNKNOWN MODELS: UNKNOWN</b></p>

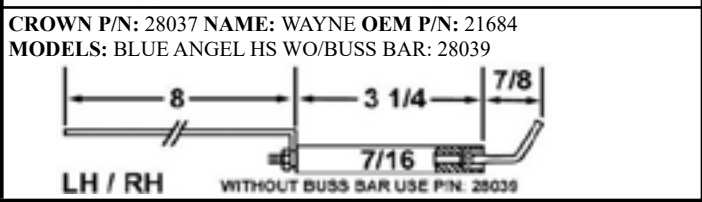
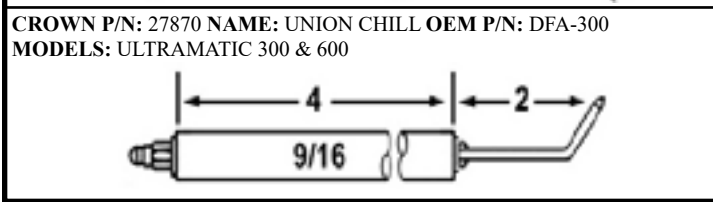
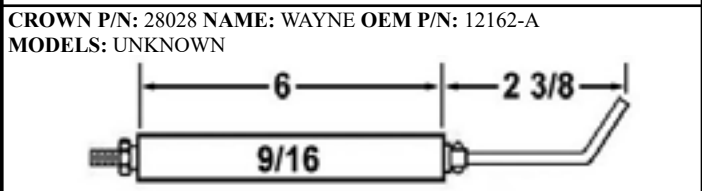
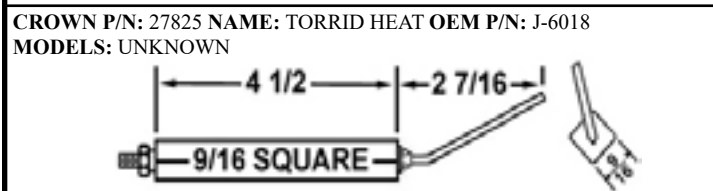
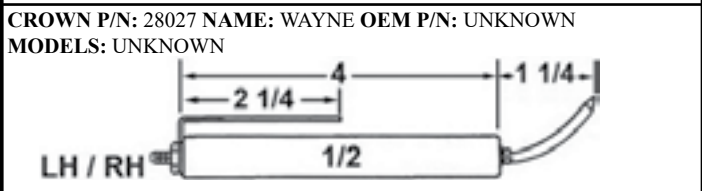
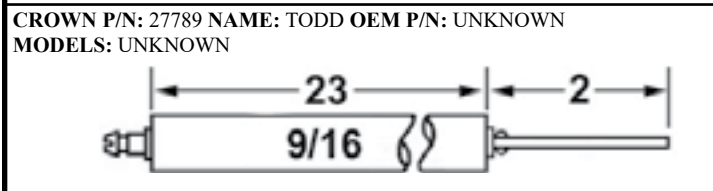
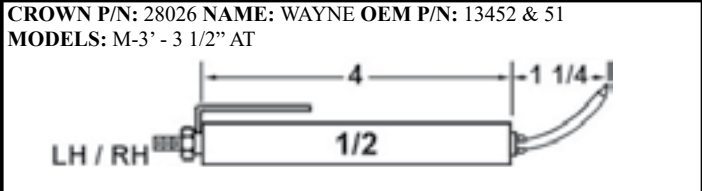
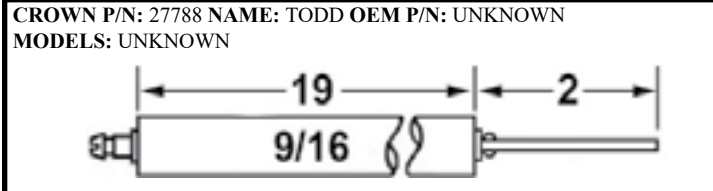
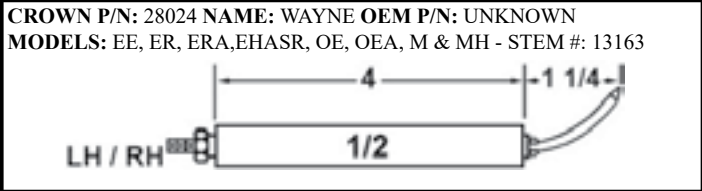
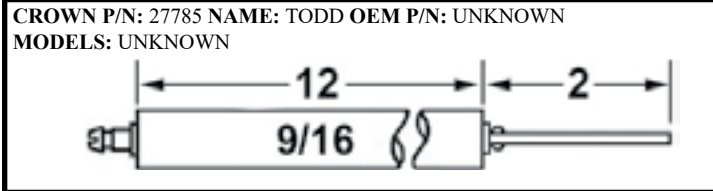
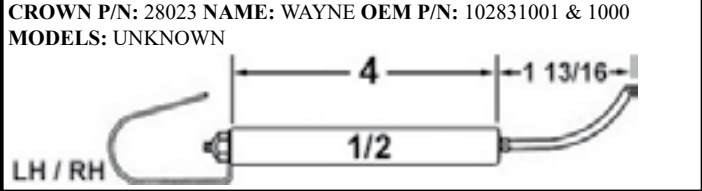
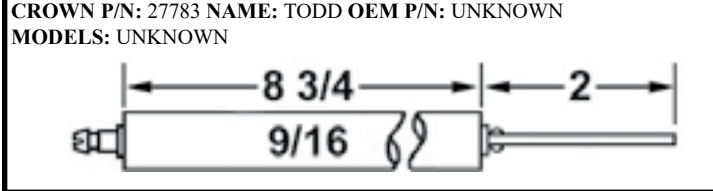
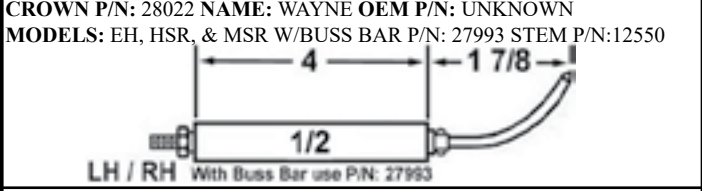
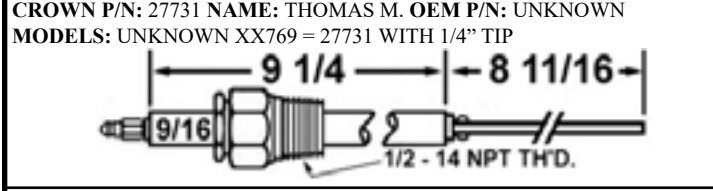
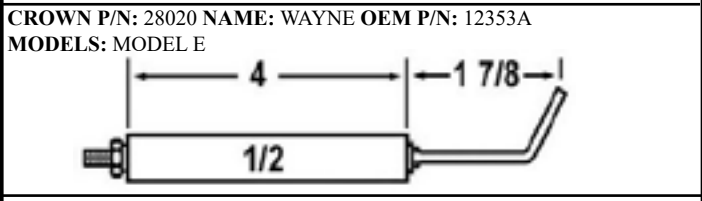
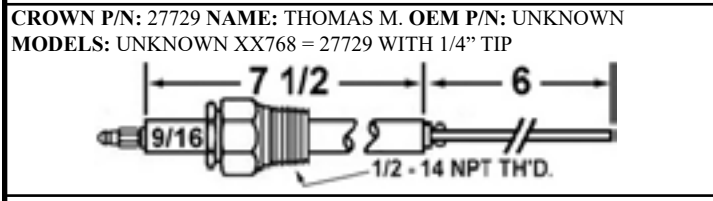
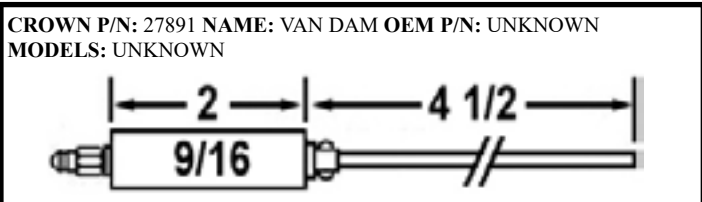
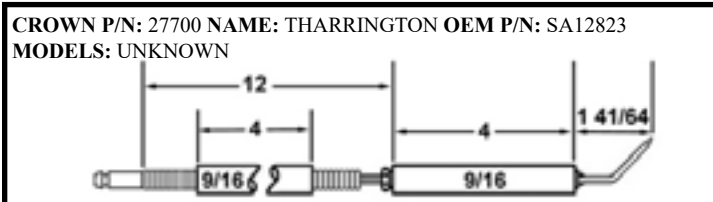





**Section 1: Electrodes**

**CROWN P/N:** 28038 **NAME:** WAYNE **OEM P/N:** 21684  
**MODELS:** BLUE ANGEL HS - HEAVY TIP

**CROWN P/N:** 28039 **NAME:** WAYNE **OEM P/N:** 21684  
**MODELS:** BLUE ANGEL HS WITHOUT BUSS BAR

**CROWN P/N:** 28040 **NAME:** WAYNE **OEM P/N:** 13934 & 13933  
**MODELS:** EH PRESSURE WASHER

**CROWN P/N:** 28045  
**NAME:** WAYNE  
**OEM P/N:** 62390-002  
**MODELS:** HSG SENSOR

**CROWN P/N:** 28046  
**NAME:** WAYNE  
**OEM P/N:** UNKNOWN  
**MODELS:** UNKNOWN

**CROWN P/N:** 28047 **NAME:** WAYNE  
**OEM P/N:** 62391-002  
**MODELS:** HSG PROBE

**CROWN P/N:** 100989-061 **NAME:** WAYNE **OEM P/N:** UNKNOWN  
**MODELS:** BLUE ANGEL HS ONE BLOCK STYLE. TRIM BB IN FIELD TO FIT AIR TUBE LENGTHS.

**CROWN P/N:** 28084 **NAME:** WEBSTER ENG. **OEM P/N:** 220029  
**MODELS:** F / JB #1 & #2 BURNERS

**CROWN P/N:** 28091-01 **NAME:** WEIL-McLAIN  
**OEM P/N:** 644-600-048 **MODELS:** QB180 & 300.  
**NOTE:** WIRE LEADS SOLD SEPARATLY P/N: 70043-02.

**CROWN P/N:** 28302 **NAME:** YORK SHIPLEY **OEM P/N:** DBA-7303  
**MODELS:** UNKNOWN

**CROWN P/N:** 28304 **NAME:** YORK SHIPLEY **OEM P/N:** UNKNOWN  
**MODELS:** FOR DOMESTIC BURNERS

**CROWN P/N:** 28312 **NAME:** YORK SHIPLEY **OEM P/N:** 102841000  
**MODELS:** FOR INDUSTRIAL BOILERS

**CROWN P/N:** 28314 **NAME:** YORK SHIPLEY **OEM P/N:** UNKNOWN  
**MODELS:** UNKNOWN

**CROWN P/N:** 28316 **NAME:** YORK SHIPLEY **OEM P/N:** N-72074  
**MODELS:** FOR INDUSTRIAL BOILERS

**CROWN P/N:** 28324 **NAME:** YORK SHIPLEY  
**OEM P/N:** N-72970 **MODELS:** FOR INDUSTRIAL BOILERS

**CROWN P/N:** 28330 **NAME:** YORK SHIPLEY **OEM P/N:** 157313  
**MODELS:** UNKNOWN

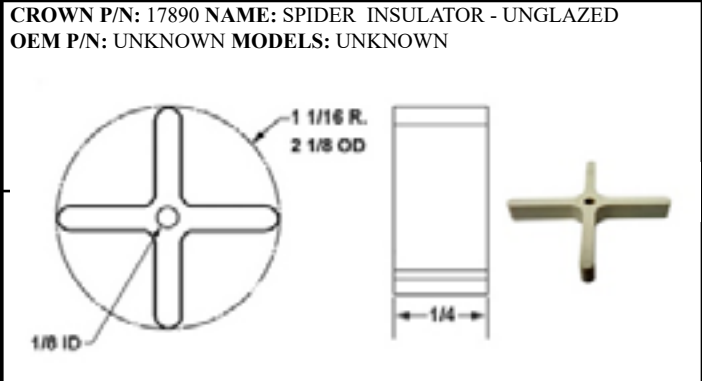
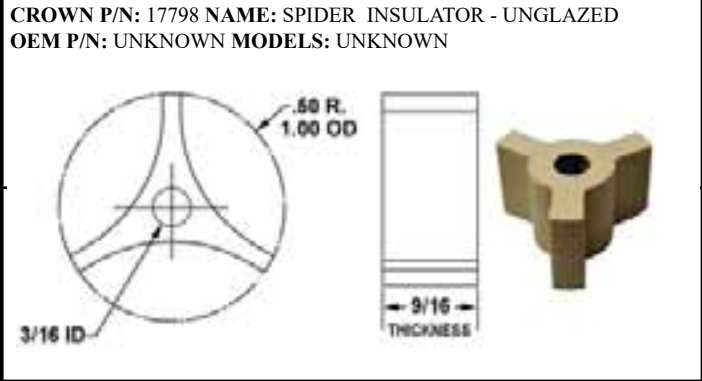
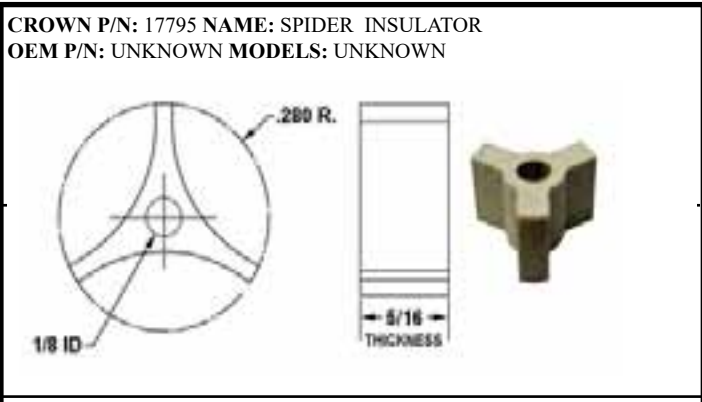
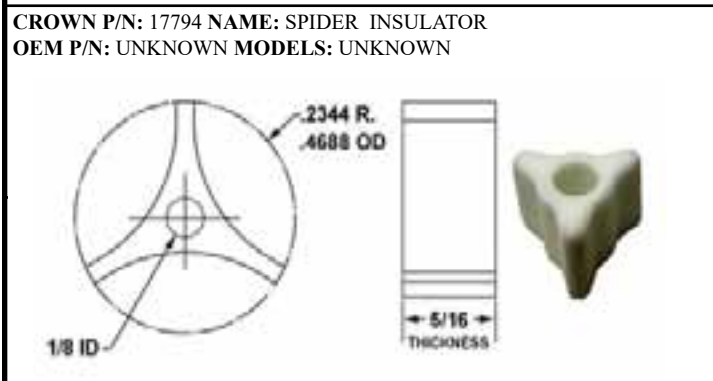
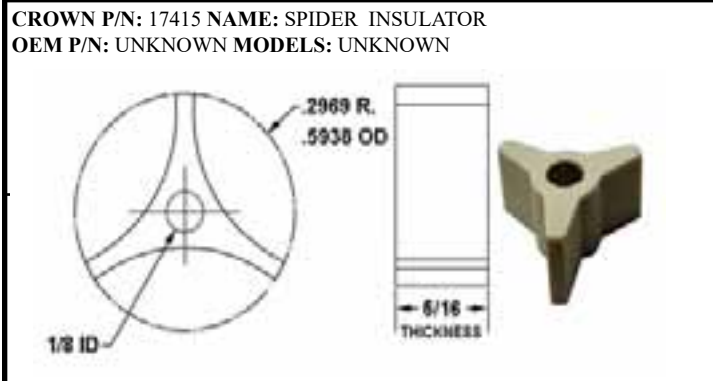
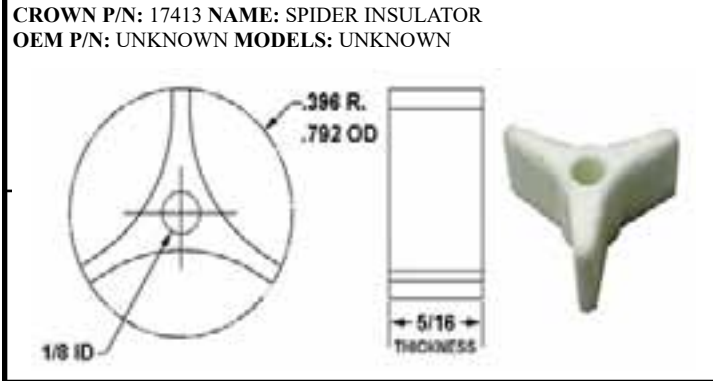
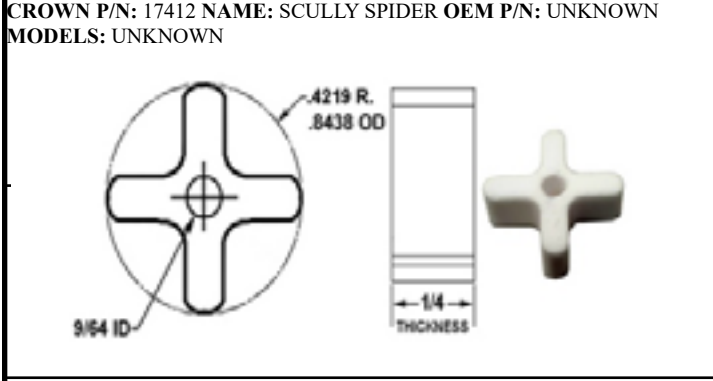
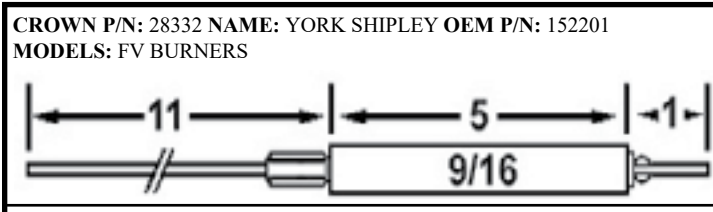

THIS SPACE LEFT BLANK INTENTIONALLY

THIS SPACE LEFT BLANK INTENTIONALLY



**Section 1: Electrodes**

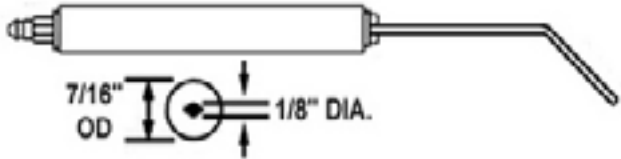

ELECTRODE PART NUMBER	INSULATOR ONLY P/N	LENGTH OF INSULATOR	TYPE OF TIP
01033	11033	3 3/4"	
01040	11040	4"	
01041	11041	4 1/4"	HEAVY
01042	11042	4 1/2"	1/8"
01043	11043	4 3/4"	DIA.
01050	11050	5"	
01060	11060	6"	

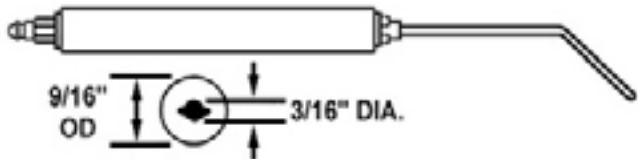

ELECTRODE PART NUMBER	INSULATOR ONLY P/N	LENGTH OF INSULATOR	TYPE OF TIP
05030	15030	3"	
05033	15033	3 3/4"	
05040	15040	4"	LIGHT
05042	15042	4 1/2"	3/32"
05050	15050	5"	DIA.
05052	15052	5 1/2"	
05060	15060	6"	
05070	15070	7"	

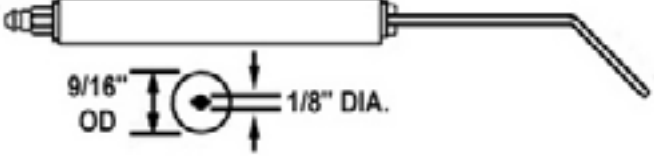

ELECTRODE PART NUMBER	INSULATOR ONLY P/N	LENGTH OF INSULATOR	TYPE OF TIP
02040	12040	4"	
02041	12041	4 1/4"	
02042	12042	4 1/2"	
02050	12050	5"	HEAVY
02052	12052	5 1/2"	1/8"
02060	12060	6"	DIA.
02070	12070	7"	
02080	12080	8"	
02090	12090	9"	

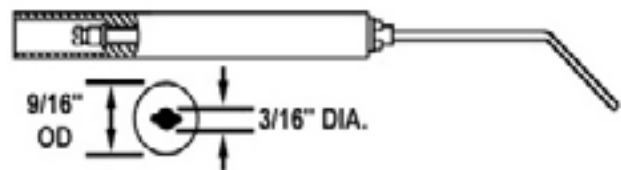

ELECTRODE PART NUMBER	INSULATOR ONLY P/N	LENGTH OF INSULATOR	TYPE OF TIP
06040	16040	4"	
06042	16042	4 1/2"	LIGHT
06050	16050	5"	3/32"
06060	16060	6"	DIA.
06070	16070	7"	



ELECTRODE PART NUMBER	INSULATOR ONLY P/N	LENGTH OF INSULATOR	TYPE OF TIP
03040	13040	4"	HEAVY
03050	13050	5"	1/8"
03060	13060	6"	DIA.

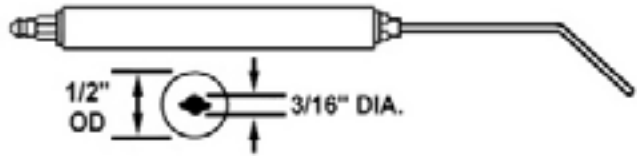

ELECTRODE PART NUMBER	INSULATOR ONLY P/N	LENGTH OF INSULATOR	TYPE OF TIP
09040	19040	4"	
09042	19042	4 1/2"	LIGHT
09050	19050	5"	3/32"
09060	19060	6"	DIA.
09070	19070	7"	
09080	19080	8"	

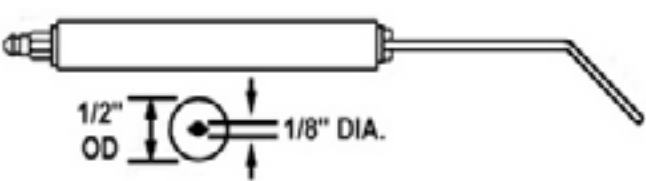

ELECTRODE PART NUMBER	INSULATOR ONLY P/N	LENGTH OF INSULATOR	TYPE OF TIP
04040	14040	4"	
04042	14042	4 1/2"	HEAVY
04050	14050	5"	1/8"
04052	14052	5 1/2"	DIA.
04060	14060	6"	

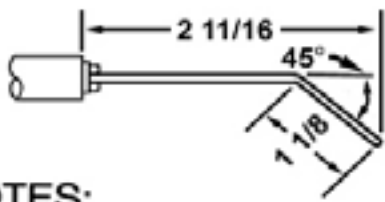

**NOTES:**  
Longer insulator lengths available upon request. Tips can be supplied straight and in standard length of 3". Longer lengths can be supplied upon request. Add the letter S, after the electrode part number, when ordering the straight electrode.  
Insulators packaged 2, 10 or 25 to a box. Add a — (dash) and the number 2, 10 or 25 to insulator P/N when ordering insulators.





# Decimal Conversion Chart

Inch	Decimal Inch	Millimeters	Inch	Decimal Inch	Millimeters
1/64	0.015625	0.396785	33/64	0.515625	13.096875
1/32	0.03125	0.79375	17/32	0.53125	13.49375
3/64	0.046875	1.190625	35/64	0.546875	13.890625
1/16	0.0625	1.5875	9/16	0.5625	14.2875
5/64	0.078125	1.984375	37/64	0.578125	14.684375
3/32	0.09375	2.38125	19/32	0.59375	15.08125
7/64	0.109375	2.778125	39/64	0.609375	15.478125
1/8	0.125	3.175	5/8	0.625	15.875
9/64	0.140625	3.571875	41/64	0.640625	16.271875
5/32	0.15625	3.96875	21/32	0.65625	16.66875
11/64	0.171875	4.365625	43/64	0.671875	17.065625
3/16	0.1875	4.7625	11/16	0.6875	17.4625
13/64	0.203125	5.159375	45/64	0.703125	17.859375
7/32	0.21875	5.55625	23/32	0.71875	18.25625
15/64	0.234375	5.953125	47/64	0.734375	18.653125
1/4	0.25	6.35001	3/4	0.75	19.05
17/64	0.265625	6.746875	49/64	0.765625	19.446875
9/32	0.28125	7.14375	25/32	0.78125	19.84375
19/64	0.296875	7.540625	51/64	0.796875	20.240625
5/16	0.3125	7.9375	13/16	0.8125	20.6375
21/64	0.328125	8.334375	53/64	0.828125	21.034375
11/32	0.34375	8.73125	27/32	0.84375	21.43125
23/64	0.359375	9.128125	55/64	0.859375	21.828125
3/8	0.375	9.525	7/8	0.875	22.225
25/64	0.390625	9.921875	57/64	0.890625	22.621875
13/32	0.40625	10.31875	29/32	0.90625	23.01875
27/64	0.421875	10.715625	59/64	0.921875	23.415625
7/16	0.4375	11.1125	15/16	0.9375	23.8125
29/64	0.453125	11.509375	61/64	0.953125	24.209375
15/32	0.46875	11.90625	31/32	0.96875	24.60625
31/64	0.484375	12.303125	63/64	0.984375	25.003125
1/2	0.50	12.7	1	1.0	25.4



**Part Number:** 100950K  
 Wayne Blue Angel + tune up kit-6" air tube  
**Packaging:** Poly bag hang card

- Includes**
- 1 - Electrode assembly (100989-013)
  - 1 - Setting gauge (14200-002)
  - 1 - Oil line 3/16" X 8" L (14452)
  - 1 - Coupler w/end caps (100386)
  - 1 - Elbow (13494)
  - 1 - Buss bar support (13276)

For use on Blue Angel Plus burner model HS up to 6" air tube.



**Part Number:** 28091K  
 Weil-McLain tune up kit QB180/300  
**Packaging:** Poly bag hang card

- Includes**
- 1 - 28091-01 Electrode assembly (644-600-048)
  - 2 - 70043 Wire ignition leads (644-000-043)
  - 1 - Oil line - straight 3/16" X 11" (40362B)
  - 1 - KK500WM Coupler with end caps (644-700-186)
  - 1 - Instruction sheet

For use on burner models QB-180 & 300



**Part Number:** 100989K  
 Wayne Blue Angel + tune up kit-over 6" air tube  
**Packaging:** Poly bagged & Tagged

- Includes**
- 1 - Electrode assembly (100989-061)
  - 1 - Setting gauge (14200-002)
  - 1 - Oil line 3/16" X 8" L (14452)
  - 1 - Coupler w/end caps (100386)
  - 1 - Elbow (13494)
  - 1 - Buss bar support (13276)

For use on Blue Angel Plus burner model HS over 6" air tubes.



**Part Number:** 31156K  
 Wayne tune up kit - E & M Series  
**Packaging:** Poly bag hang card

- Includes**
- 2 - Electrode assemblies (13286)
  - 2 - Electrode Stems (12550)
  - 2 - Buss bars 8" (10004-015)
  - 2 - Insulator bushings (12408)
  - 1 - Oil line 3/16" X 8" L (14452)
  - 1 - Coupler w/end caps (13279)
  - 1 - Setting gauge (14200)
  - 1 - Elbow (13494)
  - 1 - Buss bar support (13276)
  - 1 - Instruction sheet

For use on burner models M, MSR, MH, ERA, EH, EHA, EHASR, OE, & OEA.



**Part Number:** 31157K  
 Wayne tune up kit - Old HS  
**Packaging:** Poly bag hang card

- Includes**
- 1 - Electrode w/buss bar (21666-013)
  - 1 - Electrode w/buss bar (21667-013)
  - 1 - Setting gauge (14200-002)
  - 1 - Oil line 3/16" X 8" L (14452)
  - 1 - Coupler w/end caps (100386)
  - 1 - Elbow (13494)
  - 1 - Buss bar support (13276)
  - 1 - Instruction sheet

For use on OLD Blue Angel burner model HS

**NOTE:** This kit excludes the electrode bracket holder Wayne P/N: 21679, which is usually reused when servicing. If you would like a kit that includes the electrode holder please order our P/N: **31157KH**



**Part Number:** 21705U  
 Beckett Igniton Leads Set  
**Packaging:** Poly bagged

- Includes**
- 1 - Set of ignition leads
- For use on burner models AF II  
 1/4" quick connect transformer wires.



**Section 2 - Tune-up Kits & Service Parts**



**Part Number:** 40261  
 Adams/Beckett electrode kit  
**Packaging:** Poly bag with label  
**Includes**  
 1 - 20070 Electrode assembly  
 1 - 20417 Flame rod assembly  
 For use on G2 gas burners.

**Part Number:** 40263  
 Powerflame electrode kit  
**Packaging:** Poly bag with label  
**Includes**  
 1 - 26887 Electrode assembly  
 1 - 26894 Flame rod assembly  
 Used on Columbia boilers.

**Adams Manufacturing Electrode Set P/N: 40261**  
 Used in Beckett models G2 gas burners.

**Power Flame Electrode Set P/N: 40263**  
 Used in burner models C, J, & CG

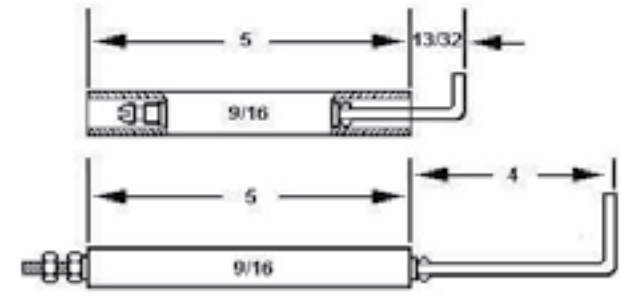
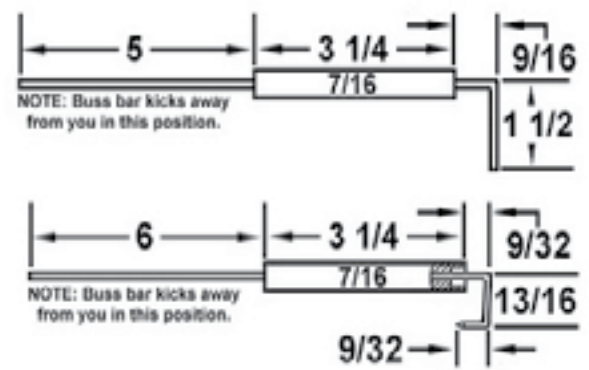

**Part Number:** 40262  
 Patterson-Kelley electrode kit  
**Packaging:** Poly bag with label  
**Includes**  
 1 - 26796 Electrode assembly  
 1 - 26798 Flame rod assembly  
 For use on burner models  
 N-700 thru N-2000

**Part Number:** 40264  
 Wayne electrode kit HSG200/400  
**Packaging:** Poly bag with label  
**Includes**  
 1 - 28045 Flame rod assembly  
 1 - 28047 Electrode assembly  
 For use on burner models HSG200 & 400

**Patterson-Kelley Electrode Set P/N: 40262**  
 Used in burner models N-700 thru N-2000

**Wayne Electrode Set P/N: 40264**  
 Used in burner models HSG200 & HSG400

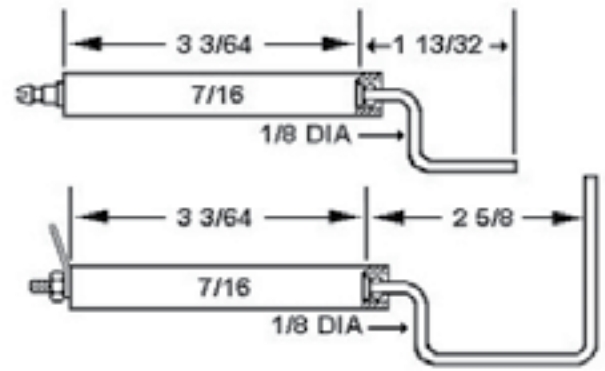
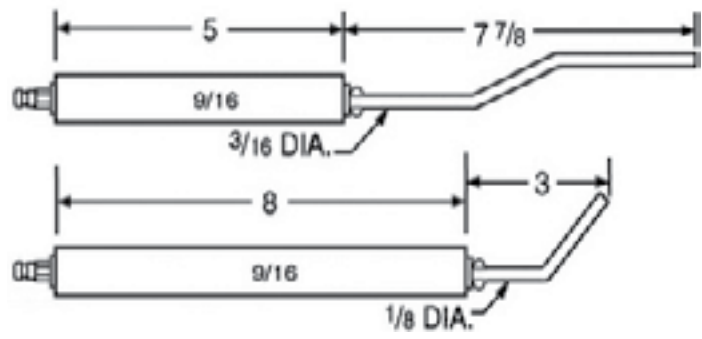





**Part Number:** 40275

Electrode ignition Kit - "PRO" kit

**Packaging:** Durable plastic carrying case

**Includes**

This kit contains a variety of ignition terminals, standard electrodes, popular OEM electrodes, and other necessary accessories to get burners up and running. Don't leave the shop without it!



**Terminals and Hardware**

<b>Quantity</b>	<b>Contents</b>
10 ea.	50000 Cage terminal
10 ea.	50100 Spring terminal
10 ea.	50200 Ring terminal
10 ea.	50450 Right angle cage terminal
10 ea.	50600 Stud ferrule
10 ea.	50760 Hex base stud 6-32 thread.
10 ea.	50700 Hex base stud 10-32 thread.
5 ea.	50860 Hollow stud 6-32 thread.
5 ea.	50800 Hollow stud 10-32 thread.
10 ea.	50900 Eyelet
10 ea.	60018 Flat hex nut 6-32 thread.
10 ea.	60022 Flat hex nut 10-32 thread.

**Special OEM Electrodes**

<b>Quantity</b>	<b>Contents</b>
2 ea.	20410 Beckett
2 ea.	20780 Carlin
2 ea.	28022 Wayne

**Special Tools**

<b>Quantity</b>	<b>Contents</b>
1 ea.	40430 Igniter tip bending set
1 ea.	40445 Electrode setting gauge

**Buss Bars**

<b>Quantity</b>	<b>Contents</b>
2 ea.	40315 Round buss bar - 12" long
2 ea.	40320 Flat buss bar - 12" long

**Standard Electrodes**

<b>Quantity</b>	<b>Contents</b>
4 ea.	01041
2 ea.	03050
2 ea.	04040
4 ea.	05040
4 ea.	05050
2 ea.	05060
2 ea.	06040
2 ea.	06042
2 ea.	06050
2 ea.	06060

**Test Jumpers, Cable, and Chart**

<b>Quantity</b>	<b>Contents</b>
1 ea.	40630 Set of booted test leads
1 ea.	5 ft. length GTO-15 ignition cable
1 ea.	Trouble shooting chart

**Section 2 - Tune-up Kits & Service Parts**



**Part Number:** 40277  
 Electrode roll-up kit "MECHANIC"  
**Packaging:** Durable plastic roll-up pouch

**Includes**  
 This kit includes 8 different standard electrodes, and 2 - O.E.M. electrode assemblies designs. It also contains 10 of the most universal insulators in the oil heat industry to restore service due to electrode or insulator failure.  
 Contains the following parts:

<u>Standard electrodes</u>	<u>Insulators</u>
2 ea. 05040	2 ea. 11041
2 ea. 05050	2 ea. 15040
2 ea. 05060	2 ea. 15050
2 ea. 06050	2 ea. 15060
	2 ea. 16050

**O.E.M. electrode**  
 2 ea. 20411 Beckett  
 2 ea. 20418B 6" buss bar



**Part Number:** 40279  
 Electrode kit "SERVICEMAN'S"  
**Packaging:** Durable plastic case

**Includes**  
 This kit includes 16 different standard electrodes, and 4 - O.E.M. electrode assemblies and 20 of the most popular insulators in the industry.  
 Contains the following parts:

<u>Standard electrodes</u>	<u>Insulators</u>
4 ea. 05040	4 ea. 11041
4 ea. 05050	4 ea. 15040
4 ea. 05060	4 ea. 15050
4 ea. 06050	4 ea. 15060
	4 ea. 16050

**O.E.M. Electrodes**  
 4 ea. 20411 Beckett  
 4 ea. 20418B 6" buss bar



**Part Number:** 40278  
 Electrode kit "MASTER"  
**Packaging:** Durable plastic roll-up pouch

**Includes:** This kit includes 20 different standard electrodes to provide a variety that will help any master mechanic to restore service due to electrode failure.  
 Contains the following parts:

<u>Standard electrodes</u>	<u>Standard electrodes</u>
2 ea. 01041	2 ea. 04040 w/hex nut
2 ea. 01060	2 ea. 04040
2 ea. 02040	2 ea. 05040
2 ea. 02050	2 ea. 05050
2 ea. 02060	2 ea. 05060



**Part Number:** 40282  
 Carlin electrode kit  
**Packaging:** Durable plastic roll-up pouch

**Includes**  
 This kit includes 22 of the most popular Carlin replacement electrodes in the field today. These O.E.M. replacements make a perfect match every time!  
 Contains the following parts:

**O.E.M. electrode(s)**

2 ea. 20710	2 ea. 20725	2 ea. 20765
2 ea. 20720	2 ea. 20730	2 ea. 20770
2 ea. 20715	2 ea. 20760	6 ea. 20780





**Part Number:** 40283  
 Beckett electrode roll-up kit

**Packaging:** Durable plastic roll-up pouch

**Includes**

This kit includes 18 of the most popular R. W. Beckett replacement electrodes. A perfect match every time!  
 Contains the following parts:

**O.E.M. electrode(s)**

- |             |             |             |             |
|-------------|-------------|-------------|-------------|
| 4 ea. 20410 | 2 ea. 20413 | 2 ea. 20437 | 2 ea. 20415 |
| 2 ea. 20411 | 2 ea. 20414 | 2 ea. 20441 | 2 ea. 20420 |



**Part Number:** 40290  
 Electrode repair kit - "Build an electrode"

**Packaging:** Durable plastic carrying case

**Includes**

This kit contains a variety of replacement insulators, rods and accessories to custom make your own electrode's for emergency and long term standard upgrades. A must for any, "NO HEAT", service call.

**Qty. Contents**

- 6 ea. 11041 Glazed insulator - 7/16" dia. x 4 1/4" long
- 6 ea. 15050 Glazed insulator - 9/16" dia. x 5" long
- 6 ea. 16050 Glazed insulator - 9/16" dia. x 5" long w/CB
- 3 ea. Package of assorted fasteners, nuts, and washers
- 2 ea. 40305 Electrode rod pack - 10-32 thread.
- 1 ea. 40300 Electrode rod pack - 6-32 thread.
- 1 ea. 40400 Terminal crimping tool / electrode rod cutter



**Part Number:** 40284  
 Wayne electrode roll-up kit

**Packaging:** Durable plastic roll-up pouch

**Includes**

This kit includes 18 of the most popular Wayne burner replacement electrodes. A perfect match every time!  
 Contains the following parts:

**O.E.M. electrode(s)**

- |             |             |             |           |
|-------------|-------------|-------------|-----------|
| 2 ea. 28020 | 2 ea. 28023 | 2 ea. 28026 | 2 ea. 280 |
| 4 ea. 28022 | 4 ea. 28024 | 2 ea. 28028 |           |



**Part Number:** 51345C  
 Beckett electrode kit CF 800/500

**Packaging:** Poly bag

**Includes:**

- 2 - Electrode assemblies
  - 1 - Instruction sheet
- For use on burner models CF 800 and CF 500 up to 8" air tube combinations.



**Part Number:** 40286K

Carlin electrode tune up kit

**Packaging:** Poly bag hang card

**Includes:**

- 2 - 20762 Electrode assemblies
  - 1 - Yellow electrode setting gauge
  - 1 - Red electrode setting gauge
  - 1 - Instruction sheet
  - 1 - KK100 coupler w/end caps
  - 1 - 12" L x 3/16" Dia. copper oil line
- For use on burner models 98 - 102, elite, 201 CRD & 301 CRD.



**Part Number:** 51346C  
 Beckett electrode kit CF 800/500 Over 8" AT

**Packaging:** Poly bag

**Includes**

- 2 - Electrode assemblies
  - 1 - Instruction sheet
- For use on burner models CF 800 and CF 500 over 8" air tube combinations.







**Part Number:** 51484U  
 Beckett electrode kit AFII-85/150  
**Packaging:** Poly bagged & tagged

**Includes:**  
 2 - Electrode assemblies  
 2 - Transformer wires  
 1 - Multi-purpose setting gauge  
 1 - Instruction sheet  
 For use on burner models AFII-85 and AFII-150 with air tube combination models HLX - HB, HC, HD, and HE up to 9" air tube combinations.



**Part Number:** 51811U  
 Beckett electrode kit model NX  
**Packaging:** Poly bagged & tagged

**Includes:**  
 2 - Electrode assemblies  
 2 - Couplings  
 2 - Rod extension - 4 7/8" L  
 2 - Rod extension - 2 7/8" L  
 1 - Instruction sheet  
 For use on burner model NX.  
 (Setting gauge sold separately, order P/N: 40439)



**Part Number:** 51670U  
 Beckett electrode kit AFII  
**Packaging:** Poly bagged & tagged

**Includes:**  
 2 - Electrode assemblies  
 2 - lead wires with assorted connectors  
 1 - Extension hdwr., Instruction Sheet & gauge  
 For use on burner models AFII 85 & 150 burners EA16711L for FBX burner head up to 9"



**Part Number:** 51859  
 Beckett electrode kit model CF375  
**Packaging:** Poly bagged & tagged

**Includes:**  
 2 - Electrode assemblies  
 2 - Support insulators  
 1 - Instruction sheet  
 For use on burner model CF375.

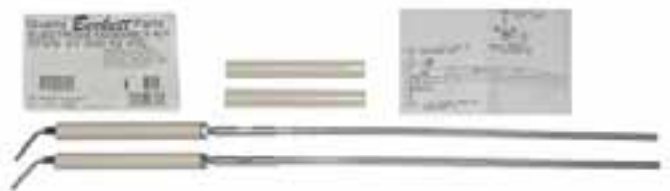

**Part Number:** 51771U  
 Beckett solid state ignitor A,AF & AFG  
**Packaging:** Boxed & tagged

**Includes:**  
 1 each Igniter With Base Plate Used in models A, AF, AFG and NX Burners. 120VAC/60HZ/35VA/6kv RMS output voltage.



**Part Number:** 5780C  
 Beckett electrode kit AFG, AF, AR,SF, SR  
**Packaging:** Poly bagged & tagged

**Includes:**  
 2 - Electrode assemblies  
 2 - Connector studs  
 2 - Extension rods  
 2 - 10/32 Hex nuts  
 1 - Instruction sheet  
 For use on burner models AFG, AF, AR, SF, & SR burners up to 9" air tube combinations.  
 (Setting gauge sold separately, order P/N: 40443)



**Part Number:** 51212C  
 Beckett electrode kit for CF1400 / CF3500  
**Packaging:** Poly bagged & tagged

**Includes:**  
 2 - Electrode assemblies  
 For use on Beckett burner models CF1400 & CF3500

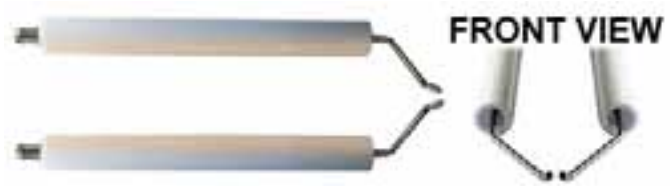



**Part Number:** 5780K  
 Beckett electrode tune up kit AF, AR, SF, & SR

**Packaging:** Poly bag hang card

- Includes:**
- 2 - Electrode assemblies w/connectors
  - 2 - Extension rods
  - 2 - 10/32 Hex nuts
  - 1 - Instruction sheet
  - 1 - KK100 coupler w/end caps
  - 1 - 12" L x 3/16" Dia. copper oil line
  - 1 - 40443 Electrode setting gauge
- For use on burner models AF, AR, SF, & SR burners up to 9" air tube combinations.

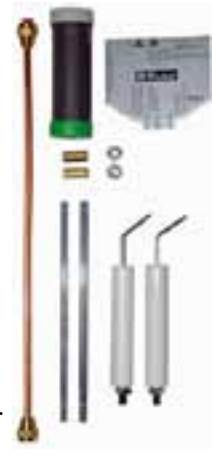

**Part Number:** 5782K  
 Beckett electrode tune up kit AF, AR, SF, & SR 9"+ AT

**Packaging:** Poly bag hang card

- Includes:**
- 2 - Electrode assemblies w/connectors
  - 2 - Secondary support insulators
  - 2 - Extension rods
  - 2 - 10/32 Hex nuts
  - 1 - Instruction sheet
  - 1 - KK100 coupler w/end caps
  - 1 - 12" L x 3/16" Dia. copper oil line
  - 1 - 40443 Electrode setting gauge
- For use on burner models AF, AR, SF, & SR burners over 9" air tube combinations.



**Part Number:** 5781C  
 Beckett electrode kit model A & S

**Packaging:** Heat sealed poly bag

- Includes:**
- 2 - Electrode assemblies
  - 2 - Connector studs
  - 2 - Spring connectors
  - 2 - Extension rods
  - 2 - 10/32 Hex nuts
  - 1 - Instruction sheet
- For use on burner models A & S burners up to 9" air tube combinations.



**Part Number:** 5783  
 Beckett electrode kit model A & S 9"+ AT

**Packaging:** Heat sealed poly bag

- Includes:**
- 2 - Electrode assemblies
  - 2 - Support insulators
  - 2 - Bullet connector studs
  - 2 - Extension rods
  - 2 - 10/32 Hex nuts
  - 1 - Instruction sheet
- For use on burner models A & S burners over 9" air tube combinations.



**Part Number:** 5782C  
 Beckett electrode tune up kit AFG, AF, AR, SF, & SR

**Packaging:** Poly bagged & tagged

- Includes:**
- 2 - Electrode assemblies
  - 2 - Support insulators
  - 2 - Connector studs
  - 2 - Extension rods
  - 2 - 10/32 Hex nuts
  - 1 - Instruction sheet
- For use on burner models AFG, AF, AR, SF, & SR burners over 9" air tube combinations.  
 (Setting gauge sold separately, order P/N: 40443)



**Part Number:** 578705  
 Beckett electrode set EA22406C

**Packaging:** Poly bagged & tagged

- Includes:**
- 2 - Electrode assemblies
  - 1 - Instruction sheet
- For use on a variety of private label burner models AF & SF. Reference #EA22406C





**Part Number:** 578707C  
 Beckett electrode kit AFG, AF, SF, AF-90  
**Packaging:** Heat sealed poly bag  
**Includes:**  
 2 - 20418 Electrode assemblies (EA28406C)  
 For use on a variety of private name brand burner models. Used in models AFG, AF, SF, AF-90 series burners up to 9" air tubes.



**Part Number:** 578716  
 Beckett electrode kit AFG & SF  
**Packaging:** Poly bagged & tagged  
**Includes:**  
 2 - Electrode assemblies  
 For use on a variety of private label burner models AFG & SF. Reference #EA23906K.



**Part Number:** 578708C  
 Beckett electrode kit AFG & SF  
**Packaging:** Poly bagged & tagged  
**Includes:**  
 2 - Electrode assemblies  
 For use on burner models AFG & SF with 7 1/4" long air tubes. Reference #EA24106C



**Part Number:** 578723C  
 Beckett electrode kit AF, SF & SM  
**Packaging:** Heat sealed poly bag  
**Includes:**  
 2 - 20401 Electrode assemblies (EA15802B) used on a variety of private name brand burner models. Used in models AF, AF-44 series, SF, and SM burners. 4 1/2" air tube only.



**Part Number:** 578711C  
 Beckett electrode kit AF-10/15  
**Packaging:** Poly bagged & tagged  
**Includes:**  
 2 - Electrode assemblies  
 For use on burner models AF-10 & AF-15. Reference #EA13302B.



**Part Number:** 5940  
 Beckett electrode kit MB, & MD  
**Packaging:** Poly bag & tagged  
**Includes:**  
 2 - Electrode assemblies  
 2 - Female connector studs  
 2 - Extension rods  
 For use on burner models MB & MD burners up to 9" air tube combinations. use on burner models CF 800 and CF 500 up to 8" air tube combinations.

**Part Number:** 578712C  
 Beckett electrode kit AFG & SF  
**Packaging:** Poly bagged & tagged  
**Includes:**  
 2 - Electrode assemblies used on a variety of private name brand burner models for AFG & SF. Reference # EA21506C.





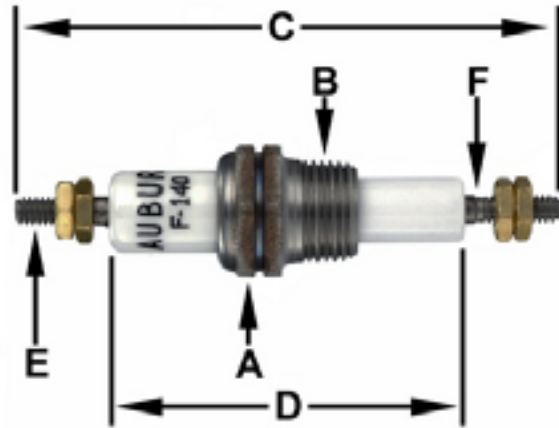

## Electric Feed-throughs

Auburn electric feed-throughs are used in oil and gas filled transformers and switching equipment.

Additional applications include terminals and overloads in hermetic air conditioning and refrigeration compressors, explosion proof electric motors, generators, autoclaves, and centrifugal and submersible pumps.

They are compact and their one piece design assures positive electrical and leak-proof connection into the pressure vessel.

AUBURN ELECTRIC FEED- THROUGH ELECTRODES										
P/N	A	B	C	D	E	F	CONDUCTOR MATERIAL	CURRENT RATING	FLASH OVER	MAX. OPER TEMP
F-140	13/16" S/S	3/8" - 18	3.57	2.33	10 - 24	3/16" DIA	KOVAR	30 AMPS	8 KV	600° F
F-150	13/16" S/S	5/8" - 24	3.57	2.33	10 - 24	3/16" DIA	KOVAR	30 AMPS	8 KV	600° F
F-200-1H	13/16" CAD	3/8" - 18	4.45	2.71	1/4" - 20	1/4" DIA	BRASS	105 AMPS	8 KV	200° F
F-210-1H	13/16" CAD	3/8" - 18	4.45	2.71	1/4" - 20	1/4" DIA	COPPER	175 AMPS	8 KV	200° F
F-230-1H	13/16" CAD	5/8" - 18	4.45	2.71	1/4" - 20	1/4" DIA	COPPER	175 AMPS	8 KV	200° F
F-220-1B	13/16" CAD	5/8" - 18	4.20	2.71	1/4" - 20	1/4" DIA	BRASS	105 AMPS	8 KV	200° F
F-240LLH	7/8" CAD	1/2" - 14	5.17	3.67	1/4" - 20	1/4" DIA	BRASS	105 AMPS	14 KV	200° F
F-250LLH	7/8" CAD	1/2" - 14	5.17	3.67	1/4" - 20	1/4" DIA	COPPER	175 AMPS	14 KV	200° F
F-310-H	1 1/8" CAD	3/4" - 14	5.23	3.23	3/8" - 16	3/8" DIA	COPPER	275 AMPS	12 KV	200° F
F-610	1 3/8" CAD	1" 11 1/2	5.91	3.17	5/8" - 11	5/8" DIA	COPPER	750 AMPS	8 KV	200° F
F-630	1 3/8" CAD	1" 11 1/2	7.68	3.67	5/8" - 11	5/8" DIA	COPPER	750 AMPS	10 KV	200° F
F-670	1 3/8" CAD	1" 11 1/2	6.92	3.67	5/8" - 11	5/8" DIA	COPPER	750 AMPS	10 KV	200° F
F-690	1 3/8" CAD	1" 11 1/2	8.29	3.17	5/8" - 11	5/8" DIA	COPPER	750 AMPS	8 KV	200° F

## Champion Spark Plugs

Crown Part Number	Thread Size	Crown Part Number	Thread Size
25	14 MM	K97F	18 MM
CJ8	14 MM	*K98F	OBSOLETE
D23	18 MM	RJ12YC	14 MM
D89D	18 MM	RL87YC	14 MM
D9	18 MM	RN13LYC	14MM
ED-89D	18 MM	UD16	18 MM
F-121500	14 MM	UY6	10 MM
F-121501	14 MM	W18	7/8" - 18
F-121502	14 MM	W89D	7/8" - 18
F-121503	14 MM	W95D	7/8" - 18
F-121507	14 MM	Z6	10 MM
H-14-Y	14 MM	Z9Y	10 MM
J99	14 MM	NOTE: K97F REPLACES K98F	



SPECS FOR EACH PLUG ON PAGES TO FOLLOW

Section 3 - Industrial Igniters & Flame Rods

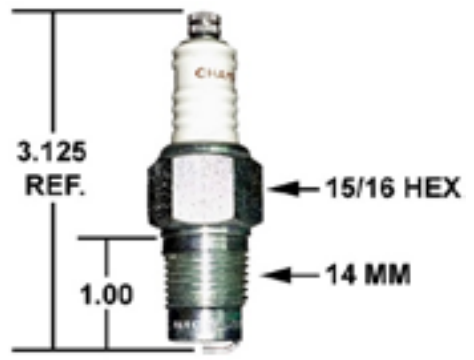

25

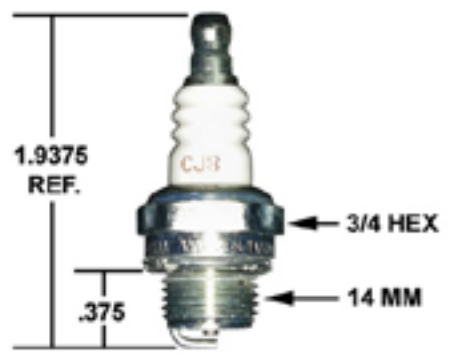

CJ8



D23



D89D



D9



ED-89D



F-121500  
(aka FI-21500)

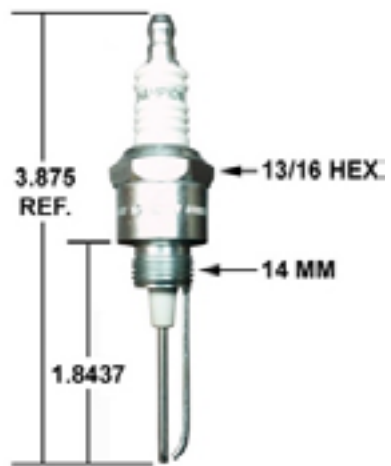

F-121501  
(aka FI-21501)



F-121502  
(aka FI-21502)

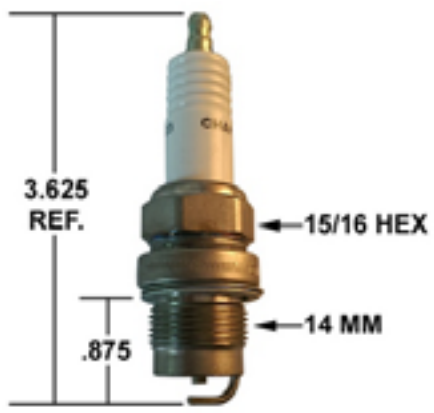

F-121503  
(aka FI-21503)



F-121507  
(aka FI-21507)



H-14-Y



J99



K97F



RJ12YC



RL87YC



RN13LYC



UD16





UY6



W18



W89D



W95D



Z6



Z9Y

**SPECIAL NOTE**

There are a number of Auburn / Champion items that are not shown in this catalog edition because of a lack of sales history or perhaps deemed obsolete by the manufacturer.

If you have a reference number you don't see, please call us to see if is still available.





**I-10-25**



**I-101**

**NOTE:** Crown generic available: CA500



**I-102**

**NOTE:** Crown generic available: CA502



**I-143**

**NOTE:** Crown generic available: CA503



**I-144**

**NOTE:** Crown generic available: CA645



**I-18**

**NOTE:** Crown generic available: CA200



**I-18-14**

**NOTE:** Crown generic available: CA210



**I-18-18**



**I-18-24**

**NOTE:** Crown generic available: CA203





**I-181**



I-182 SERIES			
PART NUMBER	"A" DIM	"B" DIM	"C" DIM
I-182	3.43	1.12	.06
I-182-1	3.53	1.25	.19



**I-18K**

NOTE: Crown generic available: CA240



PART NUMBER	"A" DIM.	"B" DIM.
I-2	8.00	4.50
I-2-1	15.50	12.00
I-2-2	27.50	24.00

I-2 SERIES		
PART NUMBER	"A" DIM	"B" DIM
I-2	8.00	4.50
I-2-1	15.50	12.00
I-2-2	27.50	24.00

**I-2 SERIES**  
 NOTE: Crown generic available:  
 CA100 thru CA102

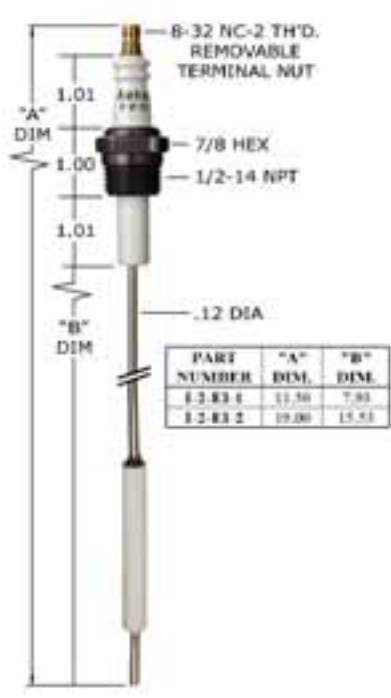

PART NUMBER	"A" DIM.	"B" DIM.
I-2-EI-1	11.50	7.94
I-2-EI-2	19.00	15.53

I-2-EI SERIES		
PART NUMBER	"A" DIM	"B" DIM
I-2-EI-1	11.50	7.94
I-2-EI-2	19.00	15.53

**I-2-EI-1 & I-2-EI-2**  
 NOTE: Crown generic available:  
 CA107 & CA108



**I-25**

NOTE: Crown generic available: CA230



**I-28**



**I-3**

NOTE: Crown generic available: CA470



**I-31**

NOTE: Crown generic available: CA505



**I-31-1 & I-31-3**

NOTE: Crown generic available for I-31-1: CA506



**I-31-2**

NOTE: Crown generic available: CA507



**I-31-5**

NOTE: Crown generic available: CA510



**I-31-6**

**I-32 NO LONGER AVAILABLE**  
 USE PART NUMBER CA515



**I-33**

NOTE: Crown generic available: CA490



**I-5-99**

NOTE: Crown generic available: CA370



**I-6**

**NOTE:** Crown generic available: CA140 thru CA146



P/N	"A" DIM	"B" DIM
I-64-1	4.20	1.72
I-64-3	6.24	3.75
I-64-4	3.60	1.12

**NOTE:** Crown generics available



P/N	"A" DIM	"B" DIM
I-75-1	4.31	.81
I-75-6	3.81	.28
I-75-5*	4.21	.71

**\*NOTE:** DOES NOT HAVE A SIDE WIRE.



**I-78-2**



**I-82**

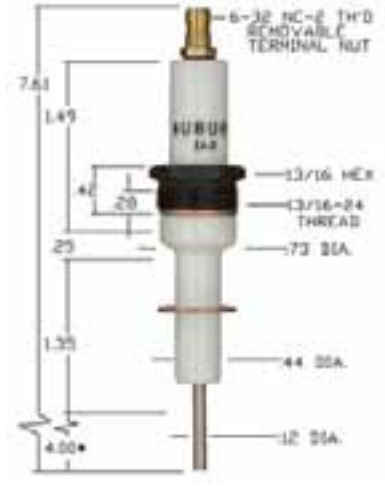

**IA-9**

**NOTE:** Crown generic available: CA180

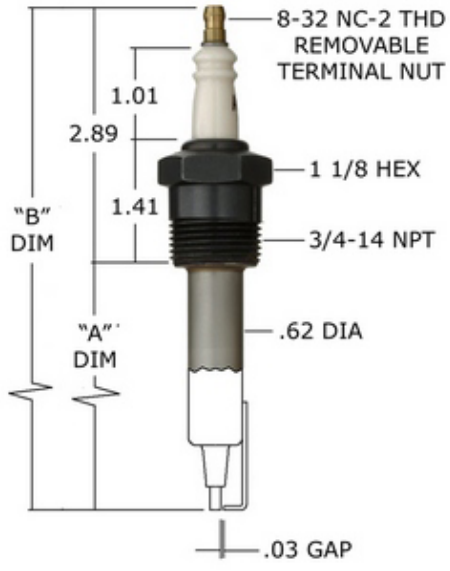

**I-90 SERIES Shrouded Igniters**

I-90 SERIES		
PART NUMBER	"A" DIM	"B" DIM
I-90-3	9.00	11.89
I-90-6	12.125	15.0125
I-90-7	10.00	12.89
I-90-8	15.75	18.64



**IC-9-2**

**NOTE:** Crown generic available: CA480

**Section 3 - Industrial Igniters & Flame Rods**





**IC-9-5**

NOTE: Crown generic available: CA482

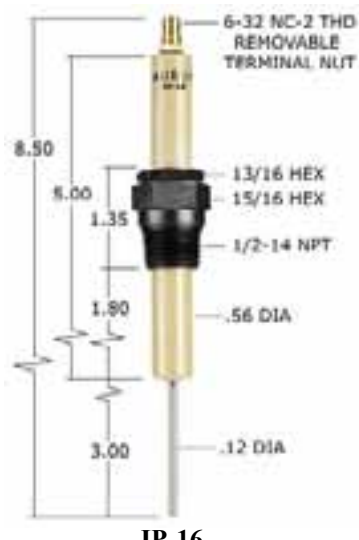

**IP-16**

NOTE: Crown generic available: CA290

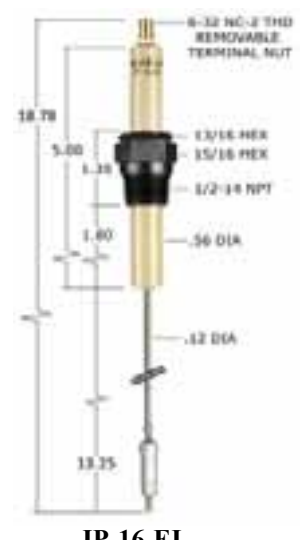

**IP-16-EI**

NOTE: Crown generic available: CA304



**IP-17**

NOTE: Crown generic available: CA310



**OJ-21-4**

NOTE: Crown generic available: CA488



**SI-140**



**SI-180**



**SI-185**



**SI-186**

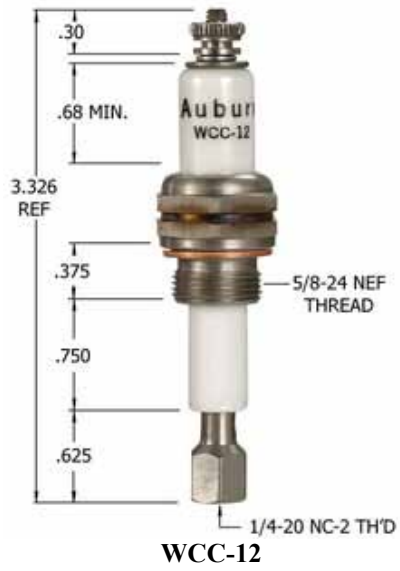

Section 3 - Industrial Igniters & Flame Rods

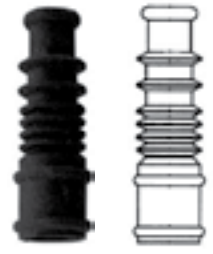

PROTECTOR BOOT		
USED ON	CATALOG NO.	MATERIAL
Flame Rods	022046	Black Silicone

**SPECIFICATIONS:**  
 Overall length: 2 3/8"  
 Top ID: 1/4"  
 Bottom ID: 1/2"  
 Temp Rating: 300 Degrees Fahrenheit

**022046**

“SI” Series Protector Boot



**50741**

90 Degree Silicone Boot - Black  
 450° F Max. temperature rating  
 For use with 7mm wire

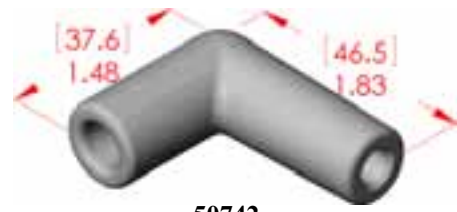

**50742**

90 Degree Silicone Boot - Grey  
 450° F Max. temperature rating  
 For use with 7mm wire

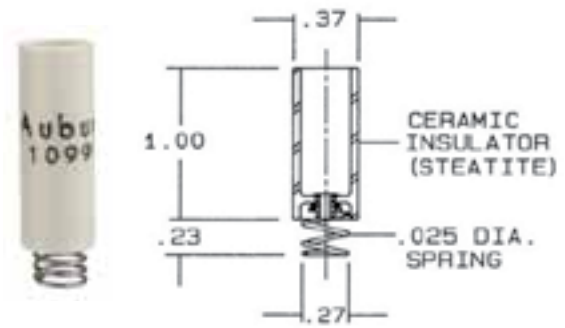

**1099-C**

Ceramic terminal connector - Auburn

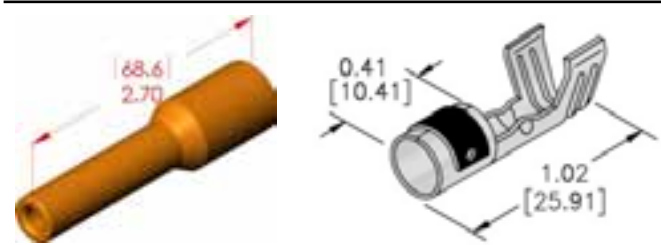

**50743**

Straight Silicone Boot - orange with terminal  
 450° F Max. temperature rating for use with 7mm wire.  
 Use crimping tool 40407 or 40408

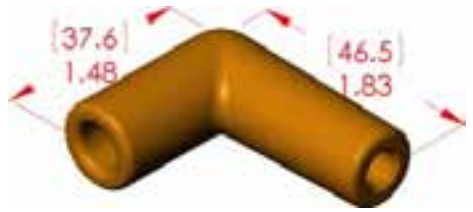

**50739**

90 Degree Silicone Boot - Orange  
 450° F Max. temperature rating  
 For use with 7mm wire

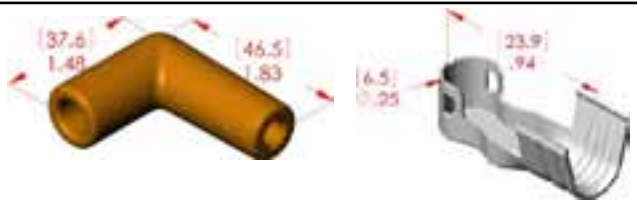

**50744**

90 Degree Silicone Boot - orange - with terminal  
 450° F Max. temperature rating for use with 7mm wire.  
 Use crimping tool 40407 or 40408

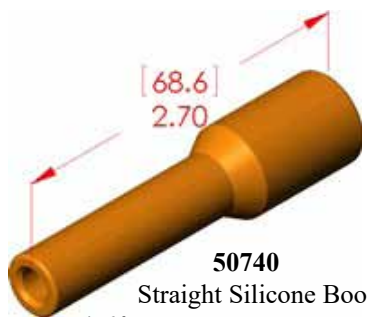

**50740**

Straight Silicone Boot  
 450° F Max. temperature rating  
 For use with 7mm wire



**50745**

Straight Ceramic Boot with terminal 2 3/8 L. Fits 9/16 dia. Ins.  
 1000° F Max. temperature rating for use with 7mm wire.  
 Use crimping tool 40407 or 40408





**50746**

90 Degree Ceramic Boot with terminal  
 1000° F Max. temperature rating for use with 7mm wire  
 Use crimping tool 40407 or 40408

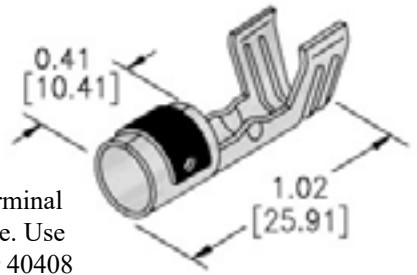

**61900**

Straight spark plug terminal  
 For use with 7mm wire. Use crimping tool 40407 or 40408

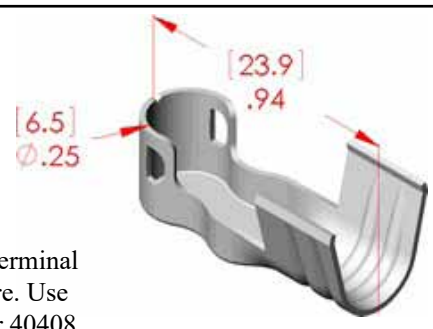

**61901**

90 Degree spark plug terminal  
 For use with 7mm wire. Use crimping tool 40407 or 40408

**Part Number(s):**

- P-380-L (3/4" HEX x 3/8" NPT TH'D. - 500 psi)
  - P-500-L (27/32" HEX x 1/2" NPT TH'D. - 500 psi)
  - P-750-L (1 1/16" HEX x 3/4" NPT TH'D. - 500 psi)
  - P-1000-L (1 3/8" HEX x 1" NPT TH'D. - 500 psi)
  - P-1140-L (1 3/4" HEX x 1 1/4" NPT TH'D. - 500 psi)
  - P-1122-L (2" HEX x 1 1/2" NPT TH'D. - 500 psi)
- Observation Ports - Lenz Brand

**Packaging:** Poly bagged & tagged

**Includes:** 1 - observation port from the above list.

Quality one piece construction. Cold rolled steel with electroless nickel plate. Bora Silica lens is heated and molded into shell body for superior sealing. Ports have Buna seals and are compatible with petroleum based fluids, gasoline, lube oil fuel and a variety of solvents.

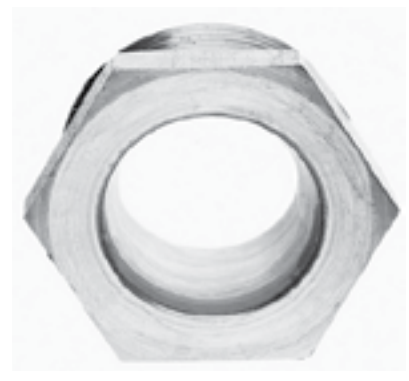

**Prodes - Stainless Steel & Brass**

Made of quality brass and stainless steel all our probes have a standard length of 24" with a threaded end.

Our probes give you the reach you need and can be cut to size in the field if it's too long.

Crown P/N	Probe DIA	Probe THD.	Material
40001B	3/16"	10-24	BRASS
40002B	1/4"	1/4-20	BRASS
40003B	3/8"	3/8-16	BRASS
40001S	3/16"	10-24	STAINLESS
40002S	1/4"	1/4-20	STAINLESS
40003S	3/8"	3/8-16	STAINLESS

**Part Number(s):**

- P-380 (3/4" hex with a 3/8"-18 thread - MOP 350 psi)
  - P-500 (7/8" hex with a 1/2"-14 thread - MOP 275 psi)
  - P-750 (1 1/8" hex with a 3/4"-14 thread - MOP 200 psi)
  - P-1000 (1 3/8" hex with a 1" - 11 1/2" thread - MOP 150 psi)
- Observation Ports - Auburn

**Packaging:** Poly bagged & tagged

**Includes:** 1 - observation port from the above list.

Unsurpassed quality! Our ports offer unitized cico-weld construction with no organic gasket. Our one piece design is compact and leakproof at high temperatures and pressures. Maximum operating temperature is 400 degrees Fahrenheit. Maximum operating pressure (MOP) range from 150 thru 350 psi as specified above.





## CA Series Industrial Igniters & Flame Rods

Crown Engineering Corporation, the original OEM manufacturer of electrodes, igniters, and flame rods for oil and gas burners, is proud to announce it's new line of industrial igniters and flame rods.

Never before has Crown's quality and workmanship been so evident, as in our NEW industrial line of igniters and flame rods. You can select from a wide variety of stocked items in this catalog or we can B.T.O. (build to order) against your submitted samples and/or drawings...your choice!

Our industrial igniters and flame rods match the original OEM critical specs from the seat of the gland nut to the tip of the center wire or from the end of the gland nut thread to the tip of the center wire, whichever is applicable. Our protruding insulator length or over-all length proves to be of no significance in the field application. All of our igniters are made of high quality heat resistant alloy (H.R.A.) center wires and grade L3 Steatite glazed insulators (except wherever noted). In high pressure applications center wires are cemented in place and Viton® O-rings are included inside the gland nut assemblies. We look forward to serving all your industrial application needs.

**Flame Rod Note:** Flame rods are for low voltage applications and are not to be used as spark igniters. They should not be used with transformers, the porcelain will fail.



P/N	"A" DIM	"B" DIM	REPLACES
CA100	8.00	4.50	I-2
CA101	15.50	12.00	I-2-1
CA102	27.50	24.00	I-2-2
CA103	39.50	36.00	I-2-36
CA104	51.50	48.00	I-2-48
CA105	21.50	18.00	I-2-18
CA106	41.56	38.00	I-2-38
CA109	54.56	51.00	I-2-51
CA110	12.56	9.00	I-2-9
CA111	33.56	30.00	I-2-30
CA112	55.56	52.00	I-2-52

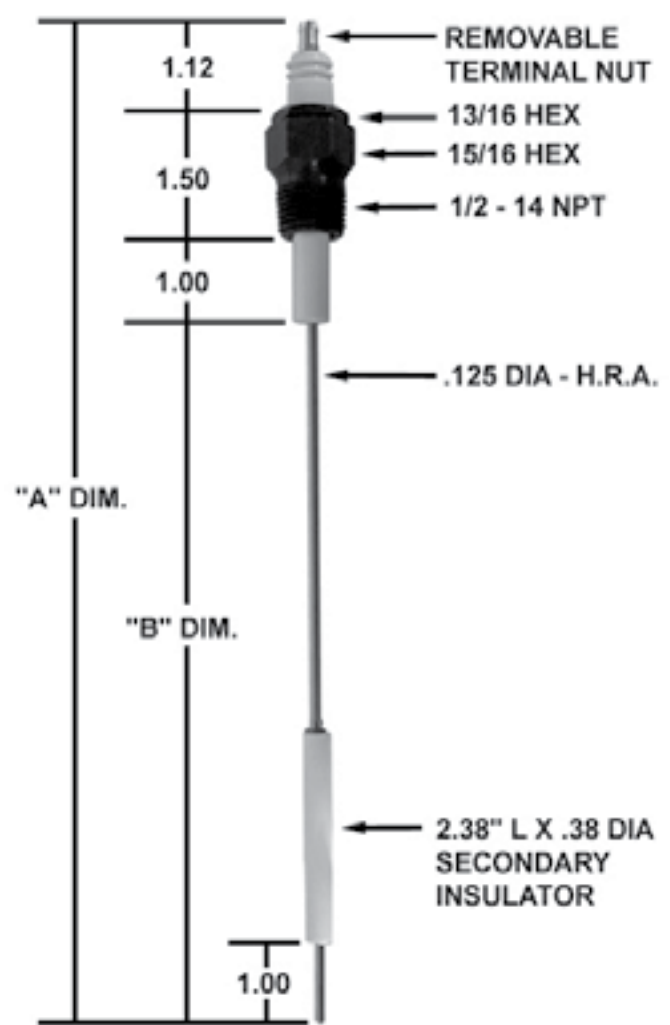

P/N	"A" DIM	"B" DIM	REPLACES
CA107	11.62	8.00	I-2-EI-1
CA108	19.37	15.75	I-2-EI-2

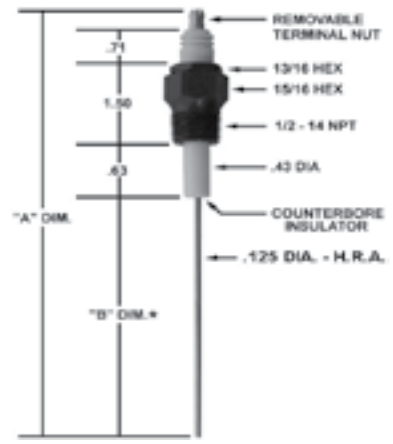
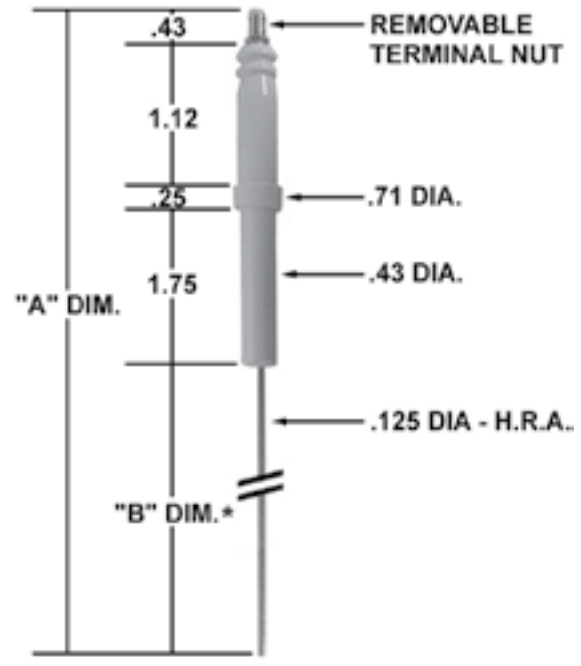

P/N	"A" DIM	"B" DIM	REPLACES
CA120	8.05	4.50	I-2 INS
CA121	15.55	12.00	I-2-1 INS
CA122	21.55	18.00	I-2-2 INS

P/N	"A" DIM	"B" DIM	REPLACES
CA140	8.14	4.90	I-6
CA141	9.24	6.00	I-6-6
CA142	15.24	12.00	I-6-12
CA143	21.24	18.00	I-6-18
CA144	27.24	24.00	I-6-24
CA145	38.24	35.00	I-6-35
CA146	51.24	48.00	I-6-48
CA149	7.43	4.50	ECL 16946-2
CA154	3.99	.75	I-6 SPEC

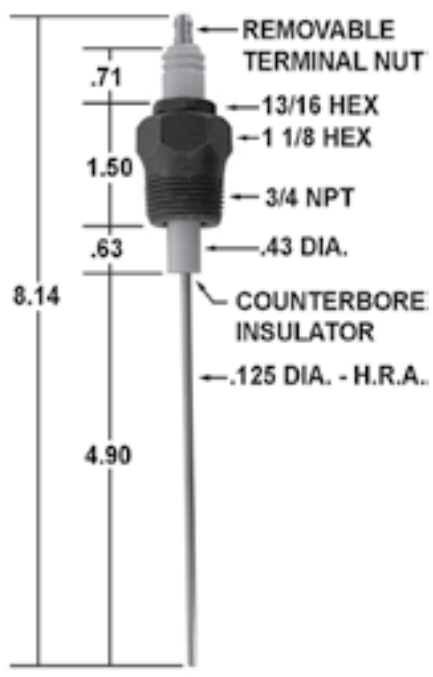

**CA155**  
**Industrial Igniter - Special**  
 \* NOTE: Other tip lengths are available

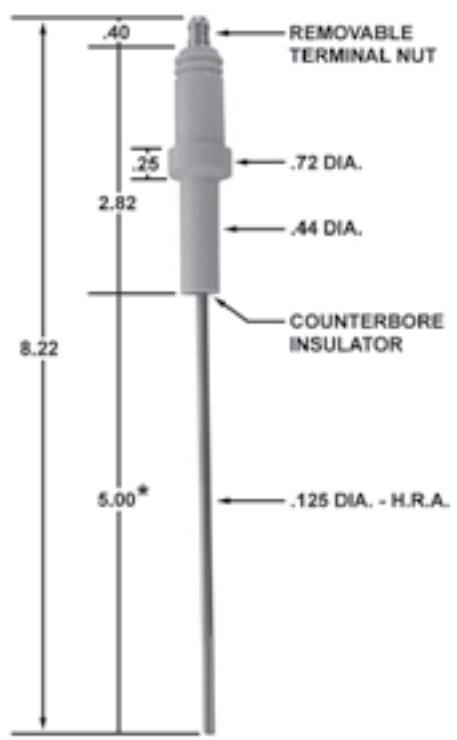

**CA160**  
**Replaces Auburn #: I-6 INS**  
 \* NOTE: Other tip lengths are available

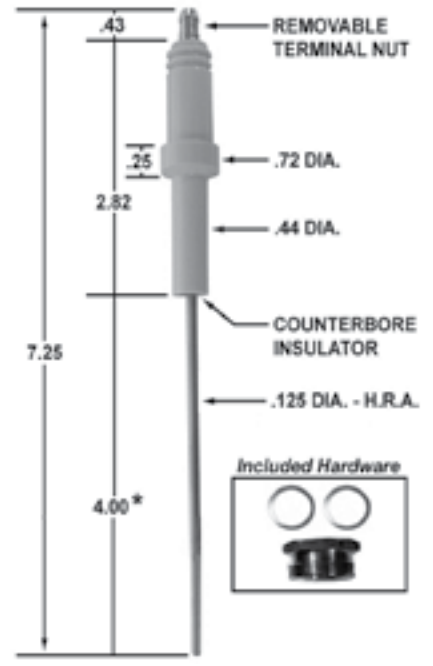

**CA180**  
**Replaces Auburn #: IA-9**  
 \* NOTE: Other tip lengths are available

**Section 3 - Industrial Igniters & Flame Rods**



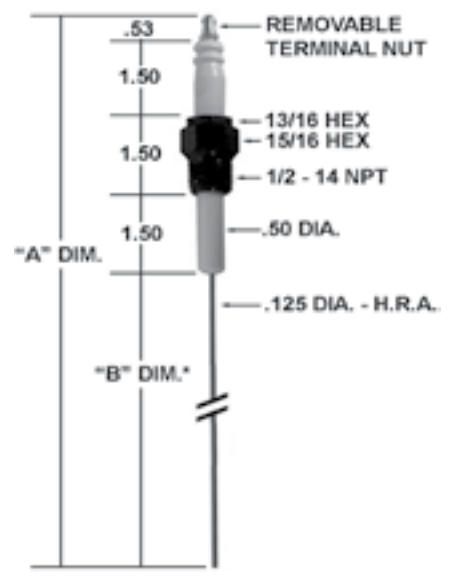
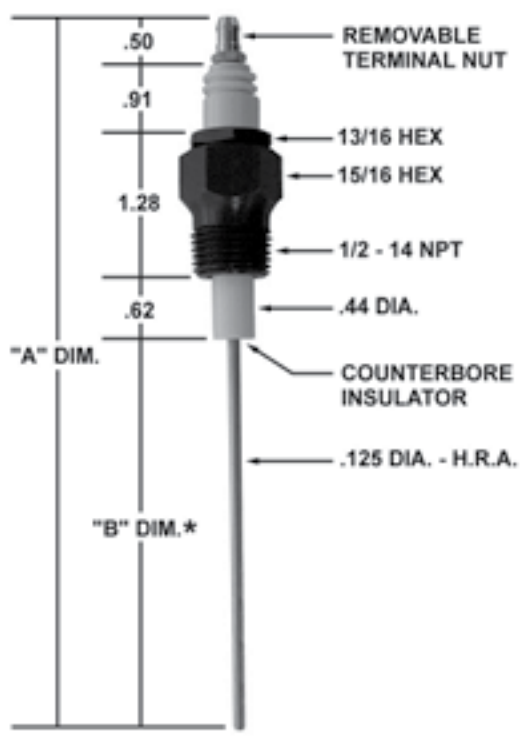

P/N	"A" DIM	"B" DIM	REPLACES
CA190	7.34	4.03	IP-9
CA191	16.31	13.00	IP-9-13
CA192	9.31	6.00	IP-9-6
CA195	27.31	24.00	IP-9-24

P/N	"A" DIM	"B" DIM	REPLACES
CA200	12.53	7.50	I-18
CA201	5.91	.88	I-18-2.38
CA202	23.03	18.00	I-18-18
CA203	29.03	24.00	I-18-24
CA203-1	30.03	25.00	I-18-25
CA204	41.03	36.00	I-18-36
CA205	53.03	48.00	I-18-48
CA206	55.03	50.00	I-18-50
CA206	77.03	72.00	I-18-72

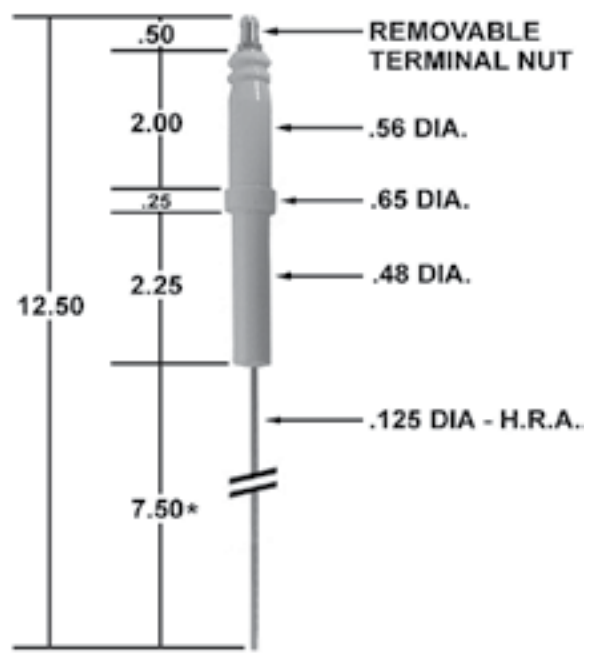
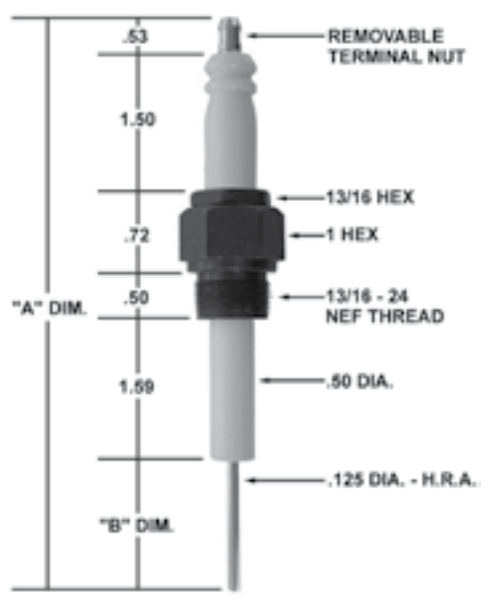

P/N	"A" DIM	"B" DIM	REPLACES
CA210	6.27	1.43	I-18-14
CA211	7.84	3.00	I-18-14-3

CA220

\* NOTE: Other tip lengths are available



P/N	"A" DIM	"B" DIM	"C" DIM	REPLACES
CA230	4.32	1.72	.09	I-25
CA231	6.35	3.75	.09	I-25-3
CA231U	6.19	3.75	.09	I-25-5
CA232	6.73	3.13	.12	12568
CA233	7.15	4.55	.12	17396
CA235	7.72	5.12	.06	17652

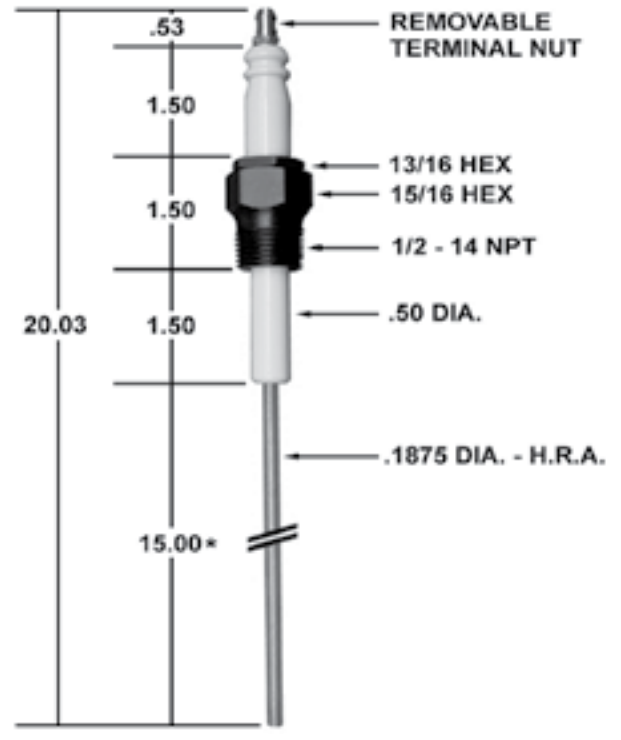

**CA240**  
 Replaces Auburn #: I-18K  
 \* NOTE: Other tip lengths are available

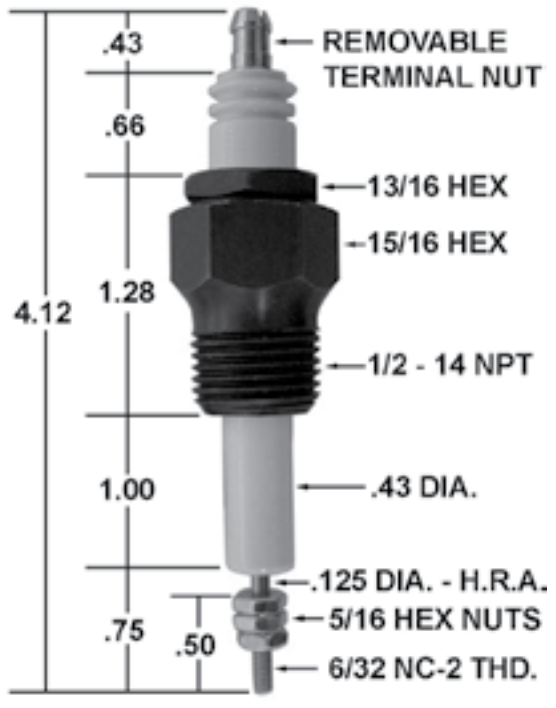

**CA250**  
 Replaces Auburn #: F-68

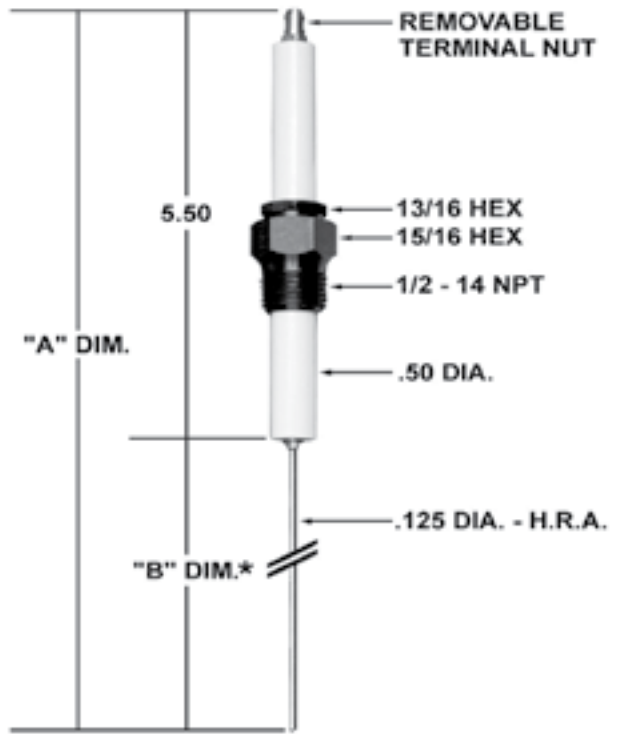

P/N	"A" DIM	"B" DIM	REPLACES
CA260	12.03	6.00	IP-15
CA262	22.03	16.00	IP-15-16

**Section 3 - Industrial Igniters & Flame Rods**



P/N	"A" DIM	"B" DIM	REPLACES
CA270	12.03	6.00	IA-15
CA280	11.21	5.21	IA-15-1

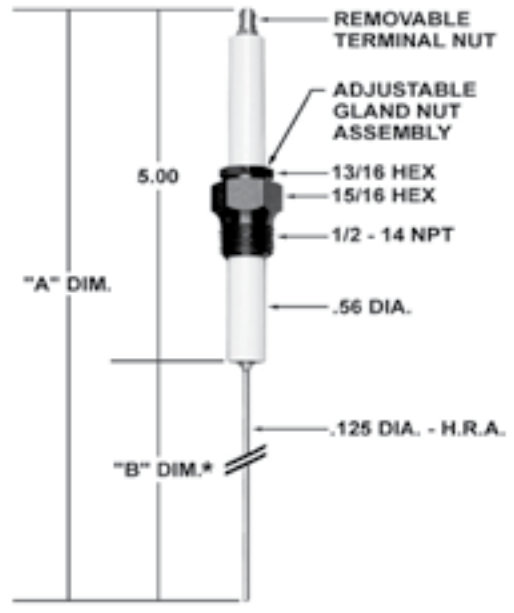

P/N	"A" DIM	"B" DIM	REPLACES
CA290	8.50	3.00	IP-16
CA291	11.50	6.00	IP-16-6
CA293	29.50	24.00	IP-16-24
CA294	35.50	30.00	IP-16-30
CA303	18.50	13.00	IP-16-13

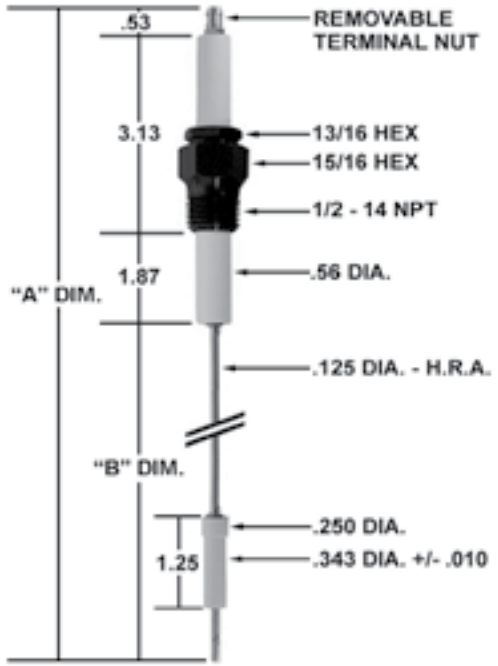

P/N	"A" DIM	"B" DIM	REPLACES
CA304	18.78	13.25	IP-16-EI
CA305	11.75	6.25	IP-16-EI-1
CA306	24.00	18.47	IP-16-EI SPEC

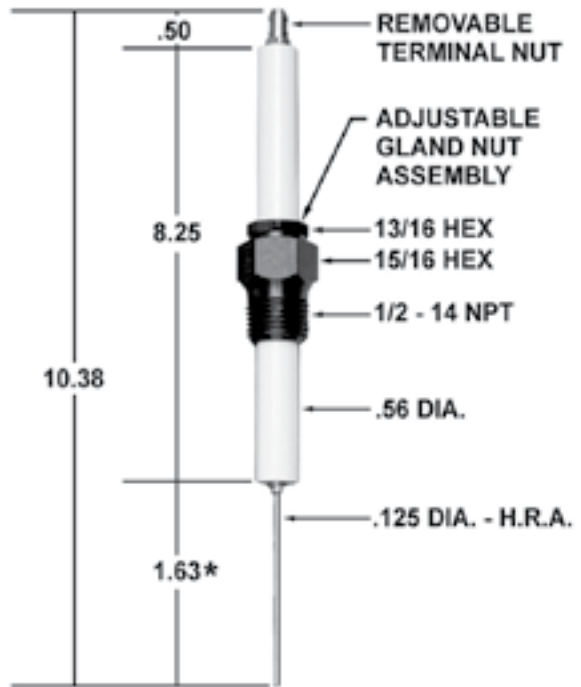

**CA310**  
 Replaces Auburn #: IP-17  
 \* NOTE: Other tip lengths are available



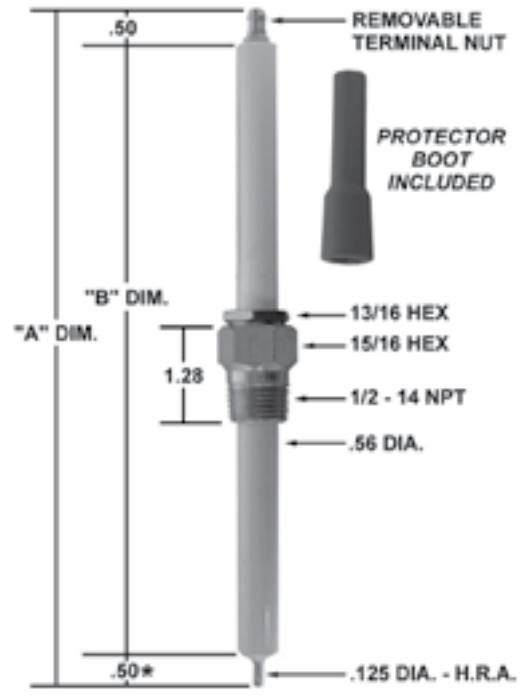

P/N	"A" DIM	"B" DIM	REPLACES
CA311	9.28	8.25	IP-17-1
CA322	7.53	6.50	IP-18-1

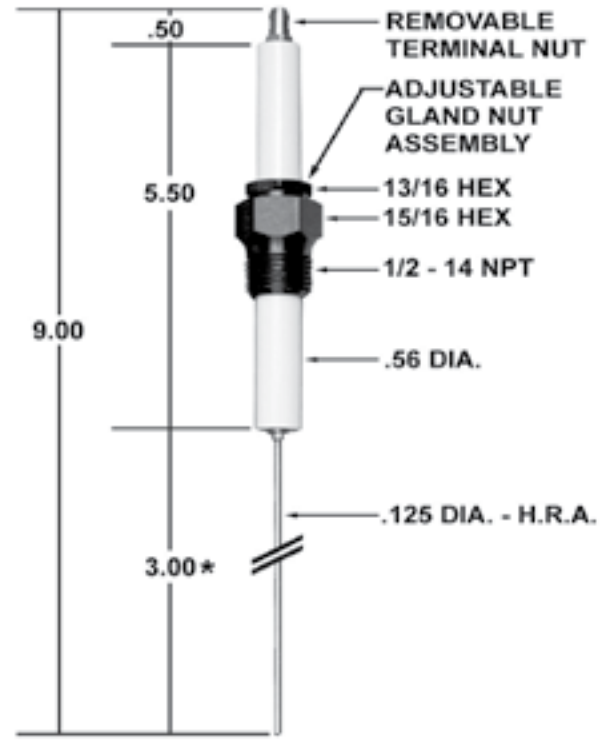

**CA330**  
 Replaces Auburn #: IP-19  
 \* NOTE: Other tip lengths are available

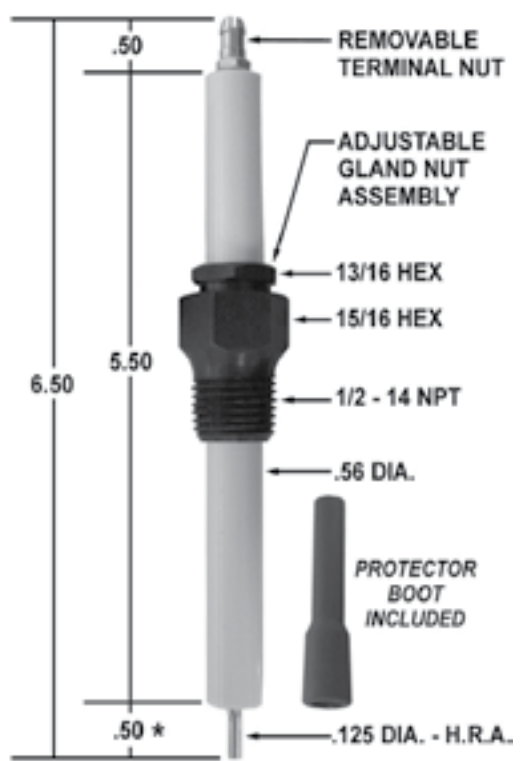

**CA331**  
 Replaces Auburn #: IP-19-1  
 \* NOTE: Other tip lengths are available

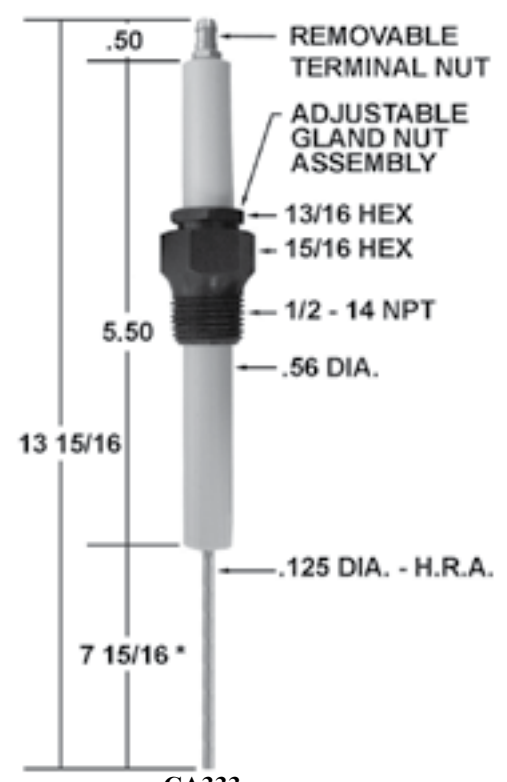

**CA333**  
 Replaces Auburn #: IP-19 with 7 15/16 tip  
 \* NOTE: Other tip lengths are available

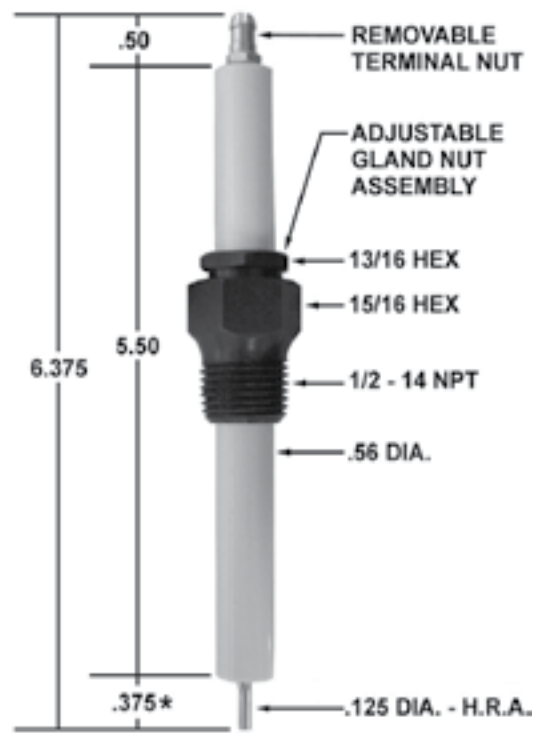

**CA341**

Replaces Maxon #: 47232  
 \* NOTE: Other tip lengths are available

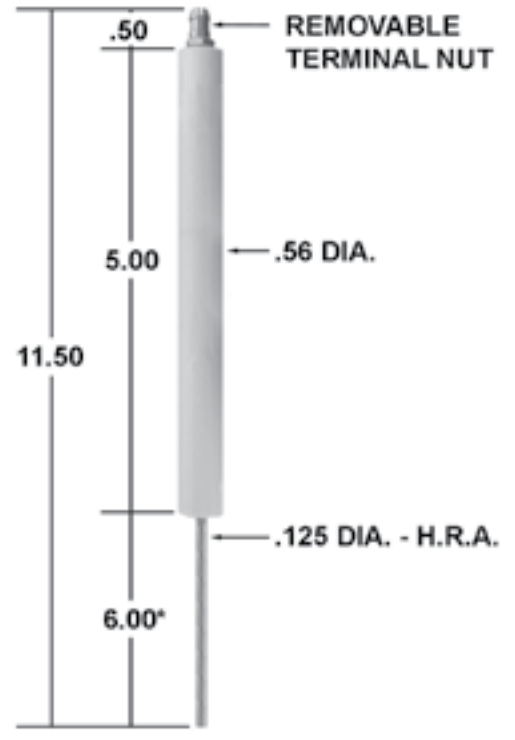

**CA350**

Replaces Auburn #: IA-16  
 \* NOTE: Other tip lengths are available

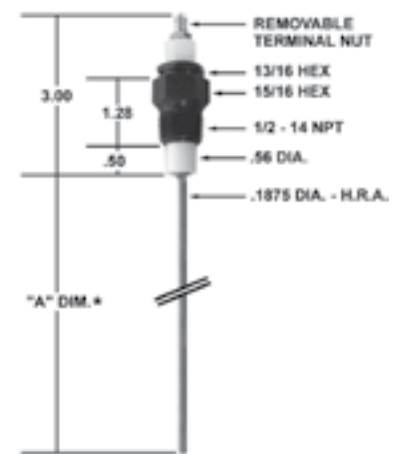
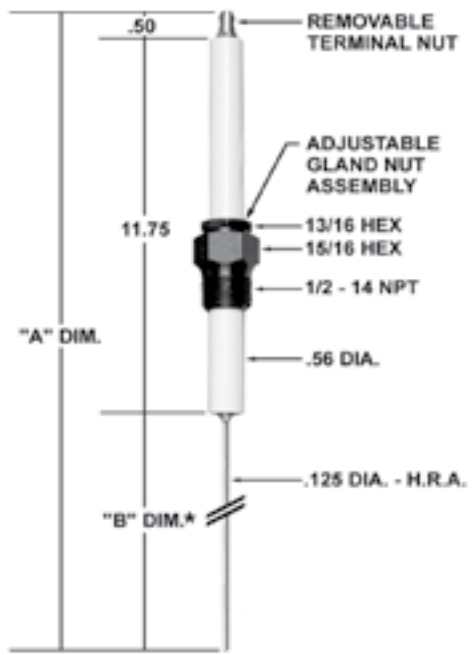

P/N	"A" DIM	"B" DIM	REPLACES
CA370	22.25	10.00	I-5-99
CA377	46.25	34.00	I-5-99-34
CA378	60.25	48.00	I-5-99-48

P/N	"A" DIM	REPLACES
CA390	6.00	FRS-2-6
CA391	12.00	FRS-2-12
CA392	18.00	FRS-2-18
CA393	24.00	FRS-2-24
CA394	36.00	FRS-2-36
CA395	42.00	FRS-2-42
CA396	48.00	FRS-2-48
CA397	66.00	FRS-2-66
CA398	72.00	FRS-2-72
CA399	50.00	FRS-2-50



P/N	"A" DIM	"B" DIM	REPLACES
CA490	15.75	6.00	43078
CA410	22.50	12.75	FRS-3
CA411	17.25	8.00	FRS-3 W/8" TIP
CA412	28.00	18.75	1042698

NOTE: OTHER TIP LENGTHS AVAILABLE

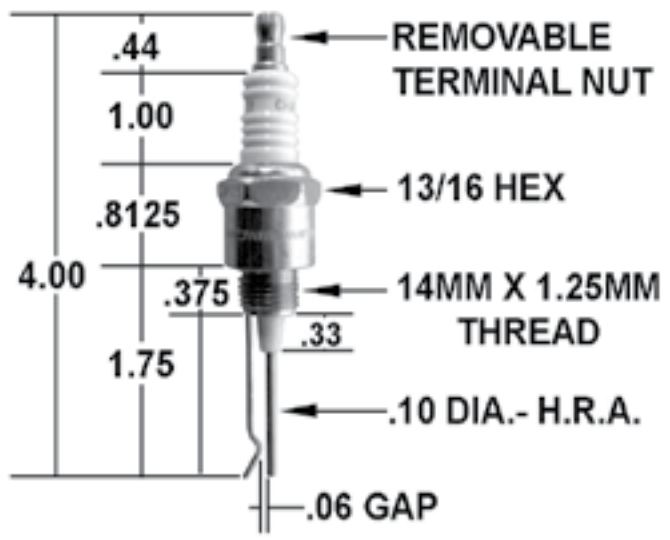
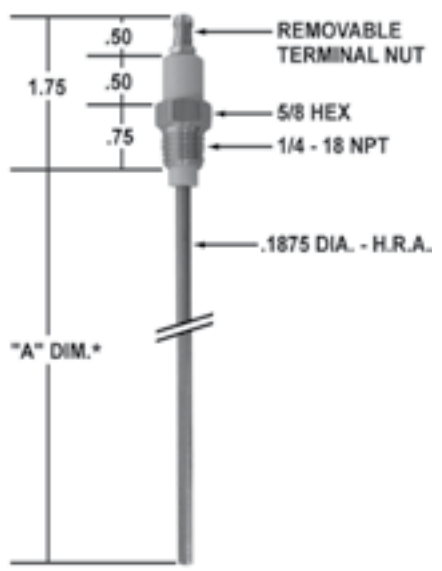
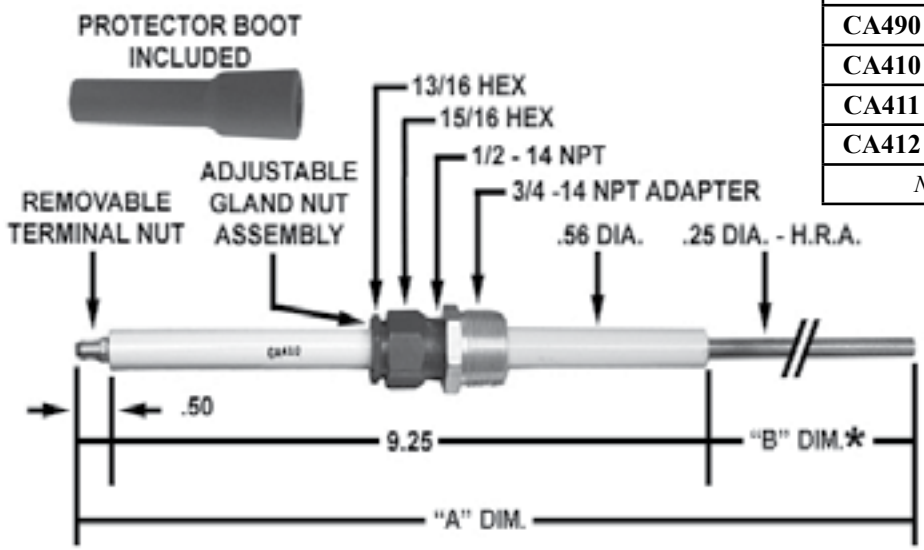

**CA470**  
 Replaces Auburn #: I-3  
 95% Alumina Ceramic

P/N	"A" DIM	REPLACES
CA429	1.00	FRS-4-1
CA430	2.00	FRS-4-2
CA431	3.00	FRS-4-3
CA431-1	3.25	FRS-4-3 1/4
CA432	4.00	FRS-4-4
CA433	4.50	FRS-4-4.5
CA434	6.00	FRS-4-6
CA435	7.50	GP-18117
CA436	12.00	FRS-4-12
CA437	18.00	FRS-4-18
CA438	24.00	FRS-4-24
CA439	36.00	FRS-4-36
CA440	48.00	FRS-4-48
CA441	60.00	FRS-4-60

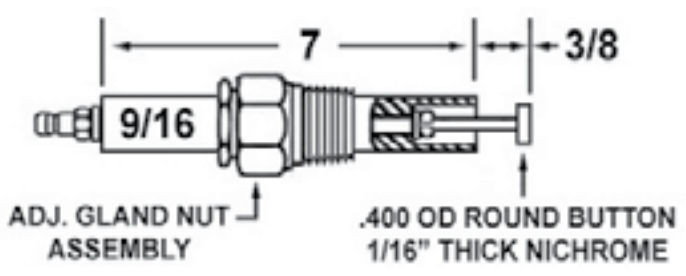

**CA345**  
 Replaces Auburn #: IP-22 & Maxon 54376

**Section 3 - Industrial Igniters & Flame Rods**



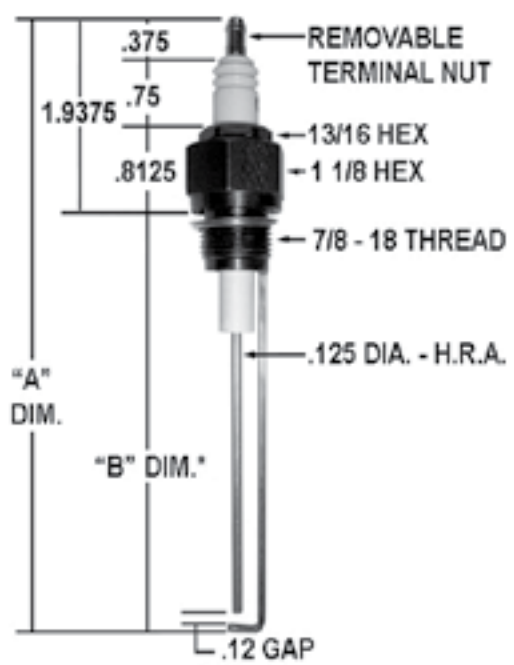
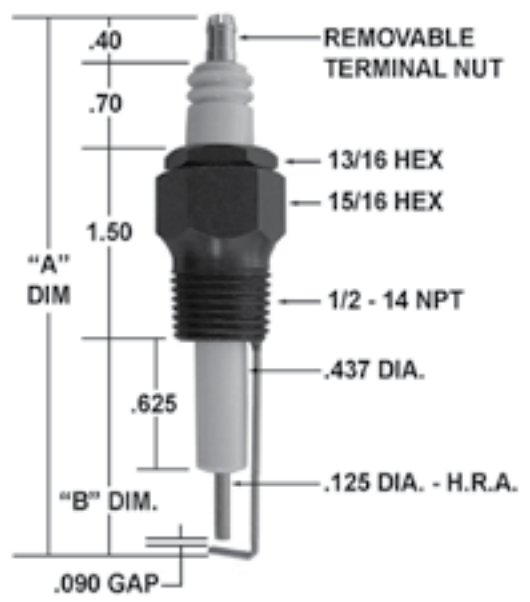

P/N	"A" DIM	"B" DIM	REPLACES
CA475	4.25	1.72	I-64-1
CA476	4.46	1.93	I-64 SPECIAL
CA477	6.39	3.75	I-64-3
CA478	3.75	1.12	I-64-4
CA479	5.10	2.53	I-64-5

P/N	"A" DIM	"B" DIM	REPLACES
CA480	6.50	3.468	IC-9-2
CA481	5.50	2.00	IC-9-4
CA482	5.87	2.375	IC-9-5

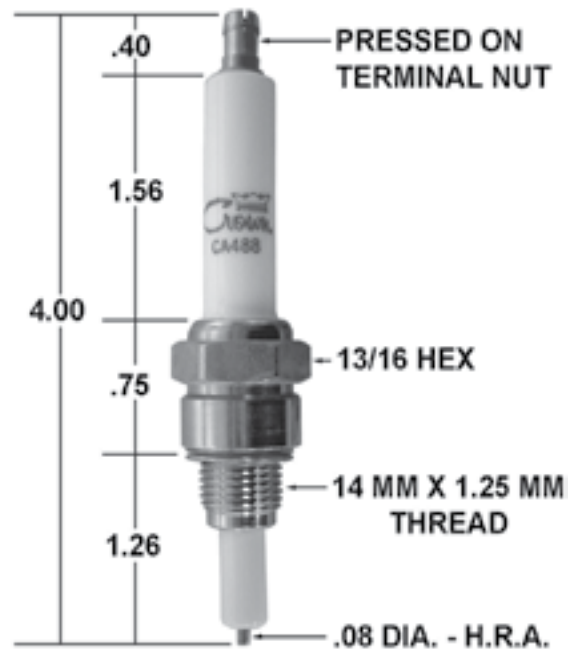

**CA485**  
 Replaces Auburn #: OJ-21-1

**CA488**  
 Replaces Auburn #: OJ-21-4

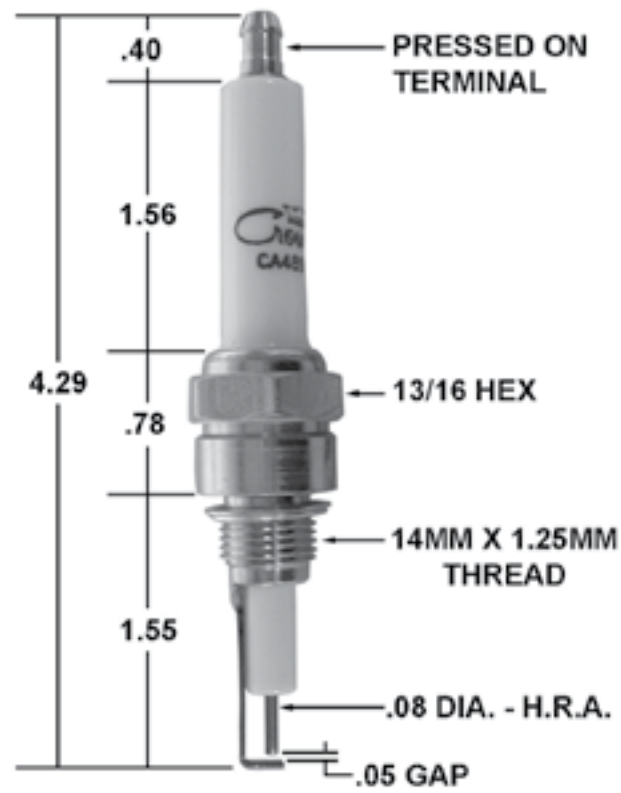

**CA489**  
 Replaces Auburn #: OJ-21-5

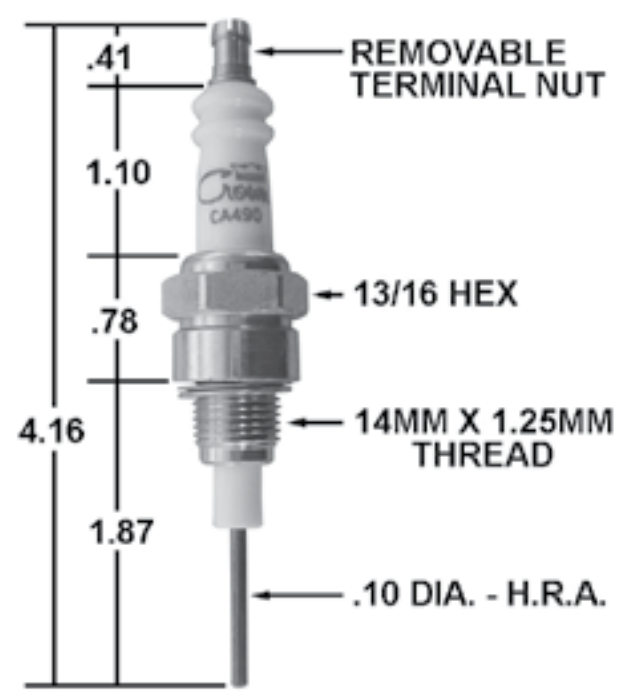

**CA490**  
 Replaces Auburn #: I-33

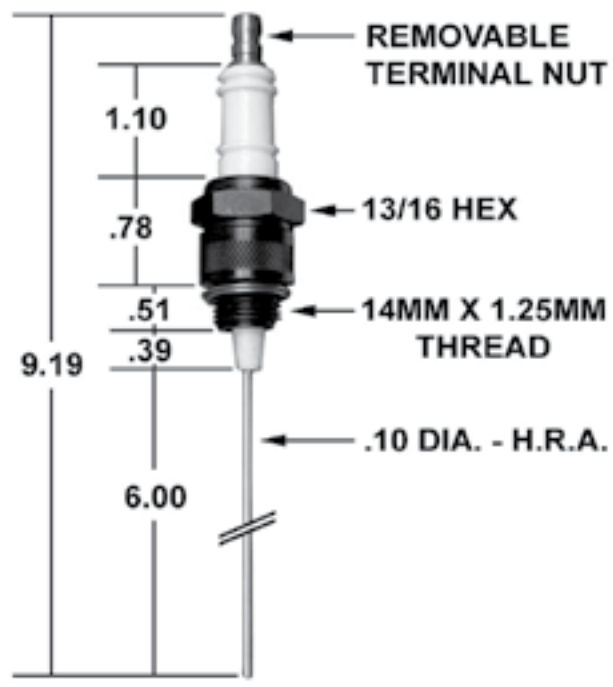

**CA496**  
 Replaces Auburn #: I-33-6



**CA500**  
 Replaces Auburn #: I-101



**CA502**  
 Replaces Auburn #: I-102

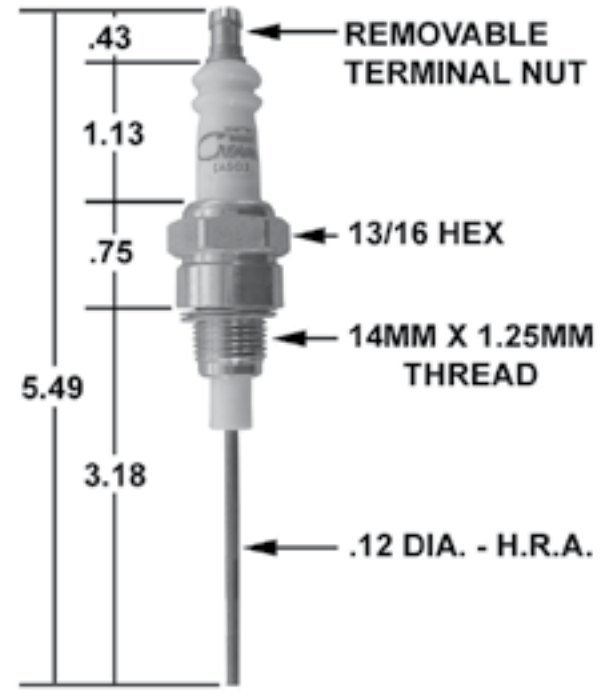

**CA503**  
 Replaces Auburn #: I-143

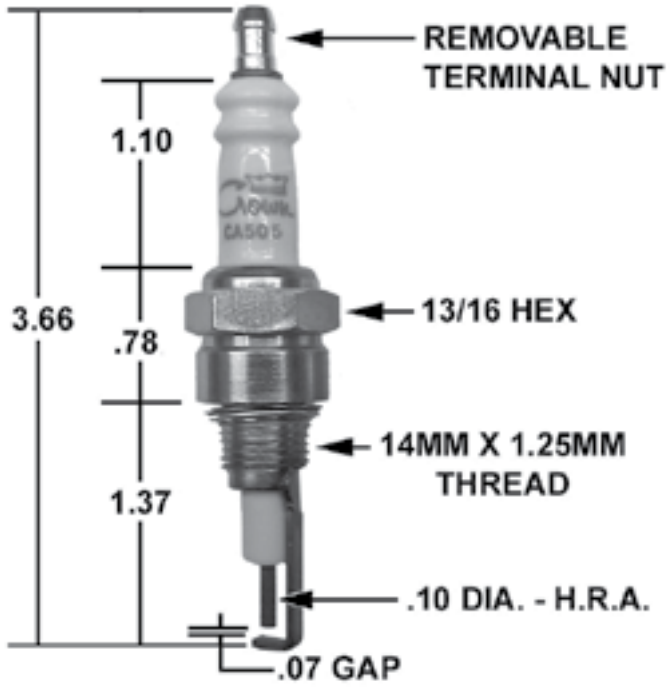

**CA505**  
 Replaces Auburn #: I-31



**CA506**  
 Replaces Auburn #: I-31-1





**CA510 & CA512 ARE NO LONGER AVAILABLE**  
 REPLACE CA510 WITH I-31-5  
 REPLACE CA512 WITH ECLIPSE 23045

**CA507**  
 Replaces Auburn #: I-31-2  
 and Eclipse #: 16927-1

PART NUMBER	"A" DIM.	"B" DIM.	REPLACES
CA510	6.26	3.97	I-31-5
CA512	6.26	3.97	ECLIPSE 23045

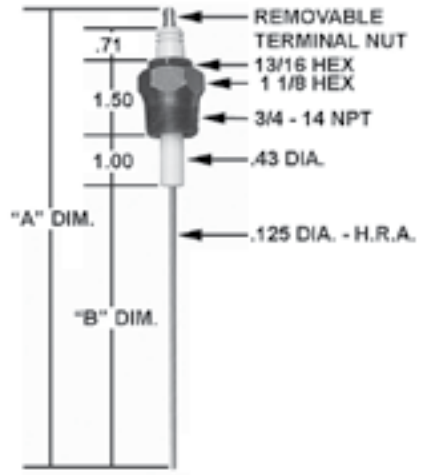
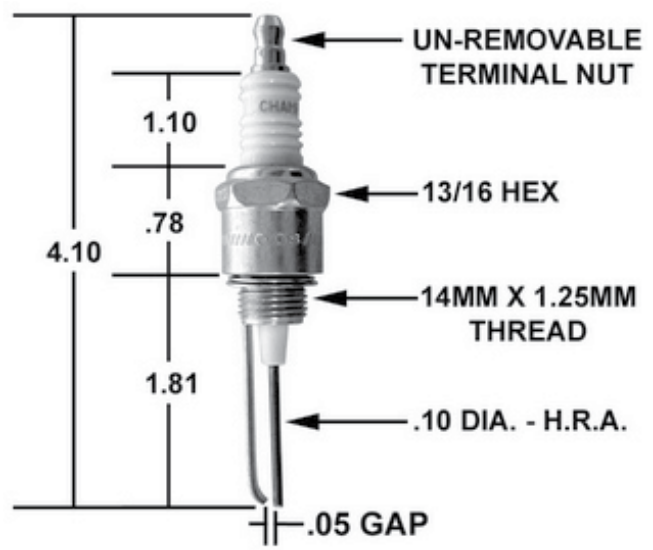

**CA515**  
 Replaces Auburn #: I-32

P/N	"A" DIM	"B" DIM	REPLACES
CA520	9.23	5.62	I-34 / 12392
CA522	5.99	2.38	I-34-2.38 / 12392-4
CA526	12.11	8.50	I-34-9.50
CA528	15.23	11.62	I-34-12 / 12392-3
CA529	23.23	19.62	I-34-20
CA530	29.23	25.62	I-34-26 / 12392-1
CA531	39.23	35.62	I-34-36
CA533	57.23	53.62	I-34-54 / 12392-2
CA536	9.61	6.00	I-34-7

**Section 3 - Industrial Igniters & Flame Rods**

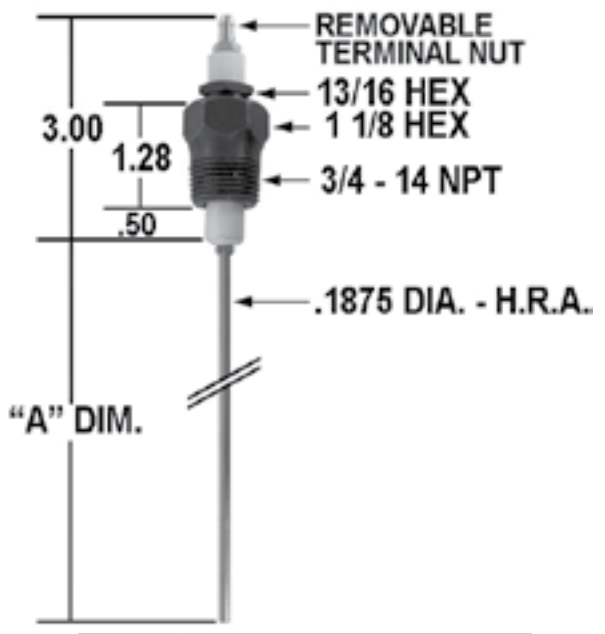

P/N	"A" DIM	REPLACES
CA540	6.00	ECLIPSE 14265-1
CA541	12.00	ECLIPSE 14265-2
CA542	18.00	ECLIPSE 14265-3
CA543	24.00	ECLIPSE 14265-4

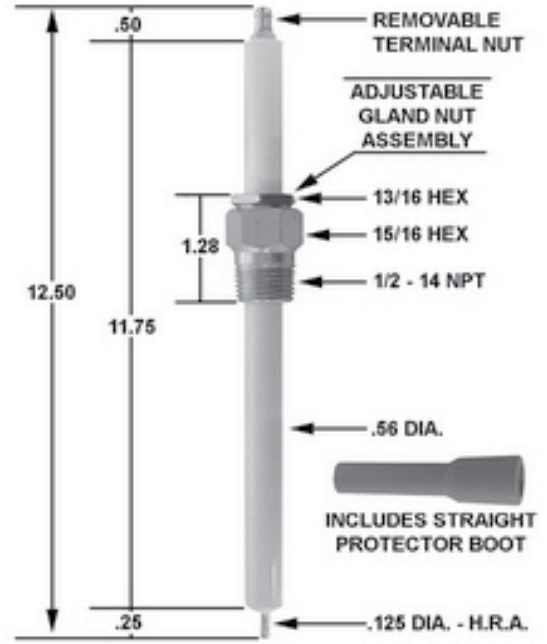

**CA566**  
 Replaces Maxon #: 42148/45979  
 \* NOTE: Other tip lengths are available

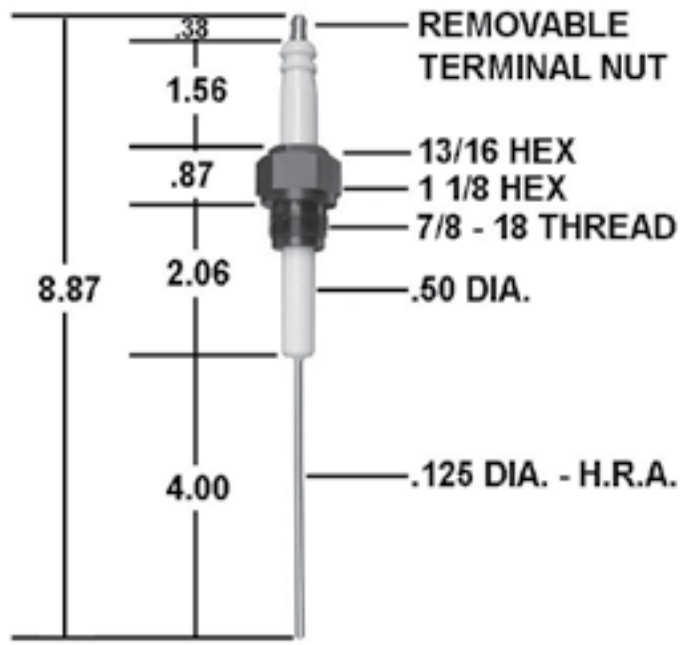

**CA607**  
 Replaces Auburn #: IC-10  
 \* NOTE: Other tip lengths are available

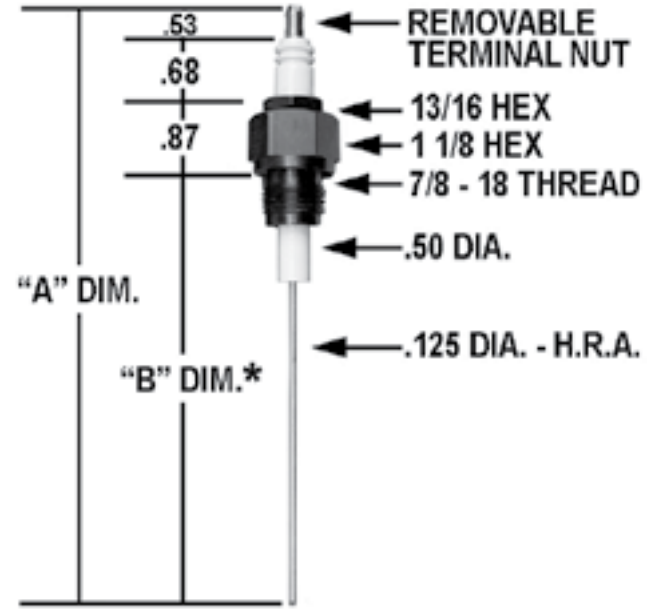

P/N	"A" DIM	"B" DIM	REPLACES
CA611	7.24	5.16	IC-9
CA613	14.08	12.00	IC-9-12
CA625	3.98	1.90	I-78

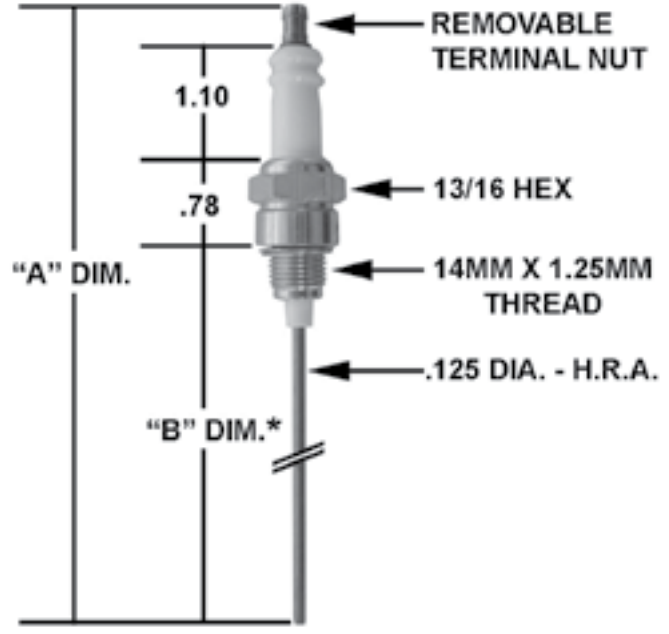
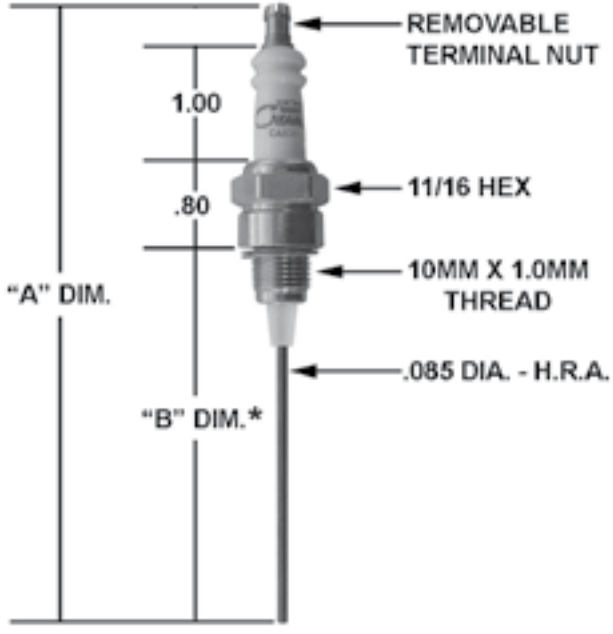

P/N	"A" DIM	"B" DIM	REPLACES
CA635	5.23	3.03	I-10-25
CA636	4.81	2.61	I-10-30-02
CA638	8.73	6.53	I-10-30-6

*NOTE: OTHER TIP LENGTHS ARE AVAILABLE*

P/N	"A" DIM	"B" DIM	REPLACES
CA645	3.79	1.50	I-144
CA646	12.66	10.37	I-144-1
CA647	14.29	12.00	I-144-12
CA648	23.29	21.00	I-144-21

## Industrial Igniter Development Page

While we cannot fathom the idea that you could not find what you were looking for in our standard line of industrial igniters, we will definitely go the extra mile to develop what you need. Our XX-series of specialty igniters are developed daily to meet the needs of "jimmy it, DIY fixes, and imaginative designs," across the globe.

Just fill in the specs, quantity, and fax it over to get price & availability in a snap!

**TIP TYPE:**  
 BLUNT   
 POINT   
 BALL

**ROD DIA.**  
 3/32"   
 1/8"   
 3/16"   
 1/4"

**THD. SIZE**  
 1/4-18 NPT   
 1/2-14 NPT   
 3/4-14 NPT   
 13/16-24 NEF   
 7/8-18

**HEX SIZE**  
 5/8"   
 15/16"   
 1"   
 1 1/8"

**TERMINAL CONNECTORS (CIRCLE ONE)**

Qty: \_\_\_\_\_  
 P/N: XX \_\_\_\_\_

Section 3 - Industrial Igniters & Flame Rods





ENGINEERING CORPORATION

## Special Electrode Development Work Sheet

PLEASE ANSWER ALL QUESTIONS & FAX TO: CROWN ENG. CORP. (F) 888-645-7278

1. What is the diameter of the Porcelain / Ceramic Insulator? (Check one box)  7/16" DIA  1/2" DIA  9/16" DIA  OTHER \_\_\_\_\_ DIA
2. What is the length of the Porcelain / Ceramic Insulator? Enter decimal inches or fractional inches only: \_\_\_\_\_
3. What is the length of the wire from the face of the Porcelain / Ceramic Insulator? \_\_\_\_\_
4. What is the diameter of the wire or rod? (Check one box):  3/32" DIA  1/8" DIA  3/16" DIA  1/4" DIA  OTHER \_\_\_\_\_ DIA.
5. Is this item going to be used as a (Check one box):  Igniter  Flame Rod  OTHER \_\_\_\_\_
6. Do you require an adjustable gland nut assembly? (Check one box):  YES  NO  
 If your answer is YES, Please select from the below options:
7. Quantity needed: \_\_\_\_\_

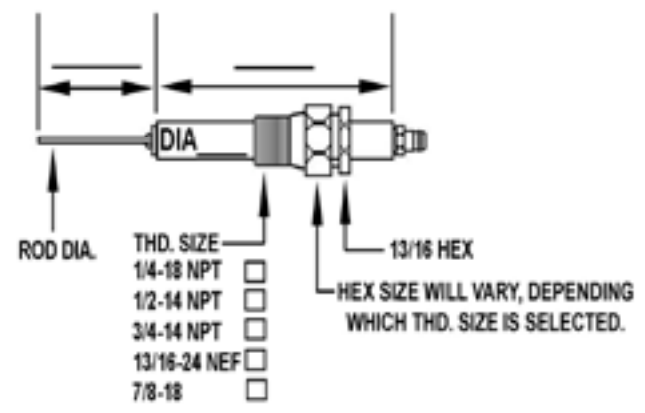

Based on the information that you have supplied, we are pleased to quote as follows:

YOUR COST: \_\_\_\_\_

LEAD-TIME: \_\_\_\_\_

USE P/N: \_\_\_\_\_

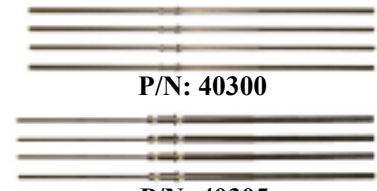

**Part Number:**  
 40300 (1/8" rod dia. X 6-32 Thread)  
 40305 (3/16" rod dia. X 10-32 Thread)  
 Electrode field replacement rod paks

**Packaging:** Poly bagged & tagged

**Includes:** 4 each of one of the above items  
 Our electrode rod paks are designed to fit Crown insulators up to 6" in length.  
 40300 fits the following ceramic diameters, 7/16", 1/2", and 9/16" with 1/8" key way bore.  
 40305 fits the following ceramic diameters, 7/16", 1/2", and 9/16" with 3/16" key way bore.

**Section 4 - Electrical**

**Part Number:** 13666  
 Honeywell Flame detector - 90° Bracket

**Packaging:** Boxed

**Includes:**  
 1 - flame detector with 30" lead.  
 1 - 90 degree bracket.  
 1 - Instruction sheet.  
 Used in Wayne burner models  
 EH(12"+tubes), HS(12"+ tubes), and FH.



**UL file:** MP268  
**UL style:** C554A

**NOTE:** For replacement eyes only see page 69

**Part Number:** 13667  
 Honeywell Flame detector - Str8 bracket

**Packaging:** Boxed

**Includes:**  
 1 - flame detector with 48" lead.  
 1 - Bracket  
 1 - Instruction sheet.  
 Used in White Rodgers equipment. Replaces Honeywell #C554A-1794. UL recognized and C.S.A. certified.



**UL file:** MP268  
**UL style:** C554A

**Part Number:** 13668 (Old P/N: TMK60)  
 Honeywell Cad Cell Kit - 6 brackets

**Packaging:** Boxed

**Includes:**  
 1 - flame detector with 60" lead.  
 6 - Brackets.  
 1 - Instruction sheet.  
 A true universal kit that meets the needs of many burner model applications.  
 Replaces Honeywell #C554A-1463.



**UL file:** MP268  
**UL style:** C554A

**Part Number:** 14289  
 Honeywell Flame detector - 17° bracket

**Packaging:** Boxed

**Includes:**  
 1 - flame detector with 15" lead.  
 1 - 17 degree Bracket.  
 1 - Instruction sheet.  
 Used in Wayne burner models MEG1, EHS, EG1(3", 6", & 9" tubes), MSR, EH(6" & 9" tubes), EH (Weil-McLain specs), HS, HS(6" & 9" tubes), HS(Weil McLain specs).  
 Also used in Bock water heater specs for MSR, EH, & HS.



**UL file:** MP268  
**UL style:** C554A

**BUSS BARS**

We stock three types of buss bar connectors available in standard lengths of 6", 8", 10", and 12". Our type "E" and "S" rounded buss bars feature annealed 1/8" diameter 303 Stainless Steel with 6-32 roll threads. Our type "F" flat buss bars feature 3/8" wide X .040 thick 260 brass alloy.



P/N	Length	Type
40309	6" Long	"E" round hook buss bar
40311	8" Long	"E" round hook buss bar
40313	10" Long	"E" round hook buss bar
40315	12" Long	"E" round hook buss bar



P/N	Length	Type
40316	6" Long	"F" flat buss bar
40318	8" Long	"F" flat buss bar
40319	10" Long	"F" flat buss bar
40320	12" Long	"F" flat buss bar



P/N	Length	Type
40322	6" Long	"S" round straight buss bar
40324	8" Long	"S" round straight buss bar
40325	10" Long	"S" round straight buss bar
40326	12" Long	"S" round straight buss bar



**Part Number(s):**

- 40630 (12" test leads)
- 40631 (18" test leads)
- 40632 (30" test leads)
- Test leads w/boots 12, 18, & 30"

**Packaging:** Poly bagged & tagged  
**Includes:**

1 pack contains 2 leads, one red, one black.  
 Our test leads are coated with a soft flexible vinyl cover. Our leads feature protector boots for added protection against accidental shock. Tips are of a jagged tooth design for maximum electrical contact and extra thick 18AWG UL wire.



**Part Number(s):**

- 41650 - 25' reel
- 41651 - 50' reel
- 41652 - 100' reel
- 41653 - 250' Box
- GTO-15 cable - 7mm

**Packaging:** Plastic reels or dispensing box  
**Includes:**

1 - Spool of GTO-15 cable  
 Our TUF-HIDE MINI SUPERFLEX® GTO-15 cable is made of solid thermoplastic elastomer. Applications include: Transformer cable leads, ignition leads, and wire connections. UL and CSA listed.



**Specifications**

**Wire Color:** Grey **Voltage:** 15 KVAC  
**Wire gauge:** 14 AWG **O.D.:** .270" +/- .002  
**Stranding:** 19 x .014" bare copper **UL style:** E - 135239  
**Insulation Thickness:** .098" **CSA style:** 74278  
**Temperature rating:** 105 degrees centigrade (221 deg. F)

**Part Number:** 40634

Test leads w/boots 20AMP

**Packaging:** Poly bagged & tagged

**Includes:**

1 - 8' test lead with red & black split.  
 Made of flexible rubber insulation this test cord features 20 amp. test clips, color coded vinyl insulators for shock protection, and jagged edged jaws for a positive connection.



**110 volt**

**Part Number(s):**

- 41660 - 25' reel
- 41661 - 100' reel
- 41662 - 500' reel
- 41662 - 50' reel
- Silicone cable - 7mm

**Packaging:** Plastic or wooden reels  
**Includes:**

1 - Spool of silicone cable  
 An advanced silicone rubber insulated ignition wiring material. Used in ovens, furnaces, air conditioning equipment and other gas fired appliances. It has been found acceptable in ignitor devices tested by the American Gas Association Laboratories. UL listed.



**Specifications**

**Wire Color:** Red **O.D.:** .274" +/- .006  
**Voltage:** 25 KVDC / 10KVAC / 60HZ **UL file:** E - 96824  
**Wire gauge:** 18 AWG **UL style:** 3257  
**Stranding:** 16/30 nickel plated copper  
**Insulation Thickness:** .113"  
**Temperature rating:** 250 degrees centigrade (482 deg. F)

**Part Number(s):**

- PS250 (25' reel for re-packaging)
- PS100 (100' reel for re-packaging)
- Cable Reels - Empty

**Packaging:** Bulk

**Includes:**

1 - Reel of selected sizes above  
 We are always looking for ways to save our customers money! You can save big on buying our GTO & Silicone cable in 500' spools then re-packaging them yourself as needed onto our 25' & 100' spools listed above.



**Empty Plastic spools are available**

For 25' reel use P/N: PS250  
 For 100' reel use P/N: PS100





**Part Number:** 41800  
 Ignition terminal kit - "Mini-Kit"  
**Packaging:** Sturdy hinged plastic box  
**Includes:**  
 20 - 50000 Cage  
 12 - 50100 Spring  
 20 - 50200 Ring  
 10 - 50400 Angle Cage  
 12 - 50600 Stud ferrule



**Part Number:** 41810  
 Ignition terminal kit - "Deluxe Kit"  
**Packaging:** Sturdy hinged plastic box  
**Includes:**  
 12 - 50000 Cage  
 12 - 50100 Spring  
 12 - 50200 Ring  
 12 - 50400 Angle Cage  
 12 - 50600 Stud ferrule  
 12 - 50760 6-32 Hex base stud  
 12 - 50700 10-32 Hex base stud  
 12 - 50860 6-32 Hollow thd. stud  
 24 - 50800 10-32 Hollow thd. stud  
 12 - 51550 Cage/Cage  
 12 - 51630 Cage/Thrd. stud  
 12 - 45580 Transformer clip  
 12 - 52210 Cage/Buss bar clip  
 12 - 52260 10-32 Hex stud  
 1 - 40400 Crimping/Rod cutter  
 12 - 52340 10-32 Spring  
 1 - 40436 Combo ratchet set 1/4" x 5/16"



**Part Number:** 41805  
 Ignition terminal kit - "Transformer kit"  
**Packaging:** Sturdy hinged plastic box  
**Includes:**  
 6 - 45580 Transformer clip  
 6 - 50800 10-32 Hollow thrd. stud  
 6 - 51550 Cage/Cage  
 6 - 52210 Cage/Buss bar clip  
 6 - 52230 Hex/Buss bar clip  
 6 - 52260 10-32 Hex base stud  
 6 - 52290 Spring adapter  
 6 - 52300 Spring adapter  
 4 - 52315 Binding post  
 4 - 52340 10-32 Spring contact  
 6 - 52350 10-32 Contact post





**Part Number:** 41813  
 Ignition terminal kit - "Build-A-Lead Jr. Kit"

**Packaging:** Sturdy hinged plastic box

**Includes:**

- 1 - 40407 Automotive crimp tool
- 10 ft - Hi-temp red silicone cable
- 10 - 50739 90 degree red silicone boots
- 10 - 50740 Straight red silicone boots
- 20 - 61900 Straight automotive terminal connectors
- 20 - 61901 90 degree automotive terminal connectors

Let's get creative! Our "Build-A-Lead Jr. kit has everything you need to create "Johnny on the spot" transformer leads. Create leads at will with our professional crimping tool for beautiful connections on demand!



**Part Number:** 41814  
 Ignition terminal kit - "Build-A-Lead Kit PRO"

**Packaging:** Sturdy hinged plastic box

**Includes:**

- 1 - 40408 Ratcheting PRO crimping tool w/attachments
- 10 ft - GTO-15 cable
- 20 ft - Hi-temp red silicone cable
- 10 - 50100 crimp on spring terminals
- 10 - 50500 crimp on angle spring terminals
- 15 - 50739 90 degree red silicone boots
- 15 - 50740 Straight red silicone boots
- 25 - 61900 Straight automotive terminal connectors
- 25 - 61901 90 degree automotive terminal connectors

For the serious PRO! Our "Build-A-Lead PRO Kit," has everything you need to create "Johnny on the spot" transformer leads, high temperature connections and everyday transformer connections. Create leads at will with our professional ratcheting crimping tool for beautiful connections with minimal effort! The tool includes 3 interchangeable jaws for professional automotive crimps, insulated wireless terminal crimps, and uninsulated wireless terminal crimps too!



**Professional Kits.....  
 That get the job done!**

**Part Number:** 41815  
 Ignition terminal kit - "Terminal & tool kit"

**Packaging:** Sturdy hinged plastic box

**Includes:**

- 24 - 50000 Cage
- 24 - 50100 Spring
- 24 - 50200 Ring
- 24 - 50300 Split ring
- 24 - 50400 Angle cage
- 24 - 50450 Right angle cage
- 24 - 51000 Ferrule/Ferrule
- 100-50900 Eyelets
- 1 - Crimping tool





**Igniter Hardware**

**Section 4 - Electrical**

**Adapter Bushings - Stainless Steel**  
 P/N: 45000 - 7/16" ID X 9/16" OD X 1/2" L  
 P/N: 45010 - 7/16" ID X 1/2" OD X 1/2" L  
 P/N: 45015 - 1/2" ID X 9/16" OD X 3/4" L



**Dravo Bushings - Steel**  
 P/N: 45020 - 9/16" ID X 5/8" OD X 1" L  
**Ray Bushing - Steel**  
 P/N: 45220 - 1/2" ID X 3/4" OD X 7/16" L



**Aerco Brass Bushing**  
 P/N: 45029 - 9/16" ID X 3/4" OD X 3/8" L  
 P/N: 45030 - 9/16" ID X 3/4" OD X 7/16" L  
 P/N: 45033 - .650 OD X .437 ID X .200 L



**Brass Bushing**  
 P/N: 45031 - 1/2" ID X 3/4" OD X 7/16" L  
 P/N: 45032 - 7/16" ID X 3/4" OD X 7/16" L



**Ray Nylon Shield**  
 P/N: 45050 - 37/64" ID X 3/4" OD X 7/8" L



**Cleaver Brooks Retainer Ring**  
 P/N: 45150 - 9/16" ID X 23/32" OD



**Walter Kidde Buss Bar**  
 P/N: 45160



**Threaded Stud**  
 P/N: 45170 - 10/32 Thd.  
 P/N: 45173 - 6/32 Thd.



**Shell Body with Inside Thread**  
 P/N: 45177 - 13/16 - 24 Thd. X 1" Hex



**Shell Body with Outside Thread**  
 P/N: 45178 - 3/4-20 NEF thd. X 13/16 - 24 NEF Thd. X 1" Hex



**Gland Nut for Shell Bodies**  
 P/N: 45180 - 13/16" Hex X 13/16 - 24 thd.



**Shell Body 33/64" hole**  
 P/N: 45190 - 1/2-14 NPT thd. X 15/16" Hex



**Shell Body 39/64" hole**  
 P/N: 45191 - 1/2-14 NPT thd. X 15/16" Hex



**Shell Body with Outside Thread**  
 P/N: 45192 - 7/8-18 thd. X 1 1/8" Hex



**Gland Nut Assembly 3/4 NPT X 1 1/8" Hex**  
 P/N: 45194 - Fits over 9/16" DIA. insulators



**Gland Nut Assembly 1/2-14 NPT Thread**  
 P/N: 45195 - Fits over 9/16" DIA. insulators

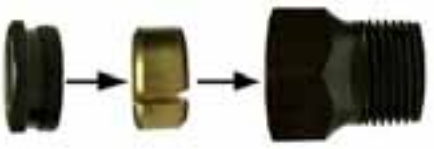

**Reducer Bushing**  
 P/N: 45196 - 3/4" NPT to 1/2" NPT











**Shell Body with Outside Thread**  
 P/N: 45197 - 13/16-24 thd. X 1" Hex

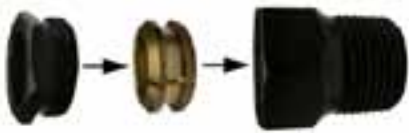

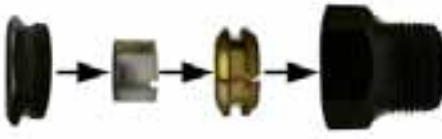



**Igniter Hardware**

<p><b>Shell Body with Outside Thread</b>                  P/N: 45198 - 3/4 NPT X 1 1/8" Hex</p> 	<p><b>Gland Nut Assembly 1/2-14 NPT Thread</b>                  P/N: 45199 - Fits over 1/2" DIA. insulators</p> 	<p><b>Copper Washer for 9/16 DIA. insulator</b>                  P/N: 45200 - 9/16" ID X 3/4" OD X .032 tk.</p> 
<p><b>Copper Washer for 1/2 DIA. insulator</b>                  P/N: 45201 - 1/2" ID X 23/32" OD X .032 tk.</p> 	<p><b>Gland Nut Assembly 1/2-14 NPT Thread</b>                  P/N: 45202 - Fits over 7/16" DIA. insulators</p> 	<p><b>Copper Washer for 7/16 DIA. insulator</b>                  P/N: 45203 - 7/16" ID X 11/16" OD X .032 thick.</p> 
<p><b>Gordon-Piatt Copper Filled Gasket</b>                  P/N: 45292 - .575 ID X .740 OD X .075 tk.</p> 	<p><b>M-Honeywell Holder - .875 ID</b>                  P/N: 45221 - .875 Pipe ID &amp; .825 Elec. ID</p> 	<p><b>Brass NPT Adapter - 1/8 to 1/4 NPT</b>                  P/N: 45293 - 9/16" Hex X 1/4 NPT</p> 
<p><b>Brass NPT Adapter - 1/4 to 1/8 NPT</b>                  P/N: 45294 - 5/8" Hex X 1/8 NPT</p> 	<p><b>Brass Hex Stud Adaptor</b>                  P/N: 45300 - .1/4" Hex X 10/32 Thread</p> 	<p><b>Need a special part or combination of parts? Why not give us a call? We would love to quote your requirements!</b></p>

**Cad Cell Eyes**

**Part Number:** 45610  
 Flame detector cad cell eyes - C-10

**Packaging:** Carded - 5 per card

**Includes:**

Our flame detectors are hand crafted and tested twice.

Once before assembly, and after. Look for them in our attractive strip packaging. Ideal POP area's.

Please order in increments of 5.

A direct replacement in the Honeywell C554A, Honeywell replacement cell part numbers 130367, 120320 and 124607.



**Specifications**

- Maximum Voltage: 30 VAC
- Maximum Resistance: Min. 300 OHMS
- During Firing: Max. 1,600 OHMS
- Max. Cell Surface Temp: 180° F
- Method of Sensing: Cadmium Sulfide





**Terminal Connectors / Rajah Style**

**Section 4 - Electrical**

CAGE 50000	SPRING 50100	RING 50200	HOOK 50250	ANGLE / CAGE 50400	RIGHT ANGLE CAGE 50450
ANGLE SPRING 50500	STUD FERRULE 50600	HEX BASE STUDS 10-32 THD. <b>50700</b> 6-32 THD. <b>50760</b> 8-32 THD. <b>50780</b>	LONG HEX BASE STUDS 10-32 THD. <b>50751</b> 6-32 THD. <b>50761</b>	HOLLOW THD. STUDS 10-32 THD. <b>50800</b> 6-32 THD. <b>50860</b> 8-32 THD. <b>50880</b>	CAGE / CAGE 51550
SPRING / SPRING 51560	CAGE / THD. STUD 10-32 THD. X 3/8" L 51630	SPRING / STUD 6-32 THD. X 1 1/8" L 51711 10-32 THD. X 3/8" L 51730	ANGLE SPRING / STUD 10-32 THD. X 3/8" L 51753	SPRING / HEX BASE 10-32 THD. <b>51900</b> 6-32 THD. <b>51960</b>	TERMINAL THUMB NUT 10-32 THD. 52200
CAGE / BUSS BAR CLIP 52210	SPRING / BUSS BAR CLIP 52220	HEX BASE / BUSS BAR CLIP 10-32 THD. 52230	LONG HEX BASE / BUSS BAR CLIP 10-32 THD. 52235	SHORT HEX STUD 10-32 THD. <b>52260</b> 3-56 THD. <b>52263</b> 6-32 THD. <b>52266</b>	BECKETT SPRING ADAPTER 52285
SHORT "A" SPRING 52290	SPRING ADAPTER 52300	SPRING / BINDING POST 52315	CAGE / BINDING POST 52316	CONTACT POST 10-32 THD. 52350	KNURLED CONTACT POST 10-32 THD. 52355
SHORT "Y" SPRING 52365	LONG "Y" SPRING 52366	HOOK / HEX BASE 10-32 THD. <b>52440</b>	SPRING / DRILLED FERRULE .096 DIA. HOLE 52571	ANGLE SPRING / DRILLED FERRULE .096 DIA HOLE 52641	CAGE / CONTACT POST 52810



**Terminal Connectors / Rajah Style**

					
CAGE / HEX BASE BUSS BAR CLIP 52830	CAGE / SHORT HEX BASE STUD 52840	CAGE / SHORT "A" SPRING 52850	CAGE / ADAPTER SPRING 52860	RIGHT ANGLE CAGE / CAGE 52880	SLOTTED HEX BASE STUD 6-32 THD. 52891
					
SMALL THUMB NUT 10-32 THD. 52900	CAGE / LARGE THUMB NUT 52915	SPRING / LARGE THUMB NUT 52916	CAGE / WEBSTER CLIP 52920	HEX BASE STUD / SHORT NYLON 55001	STUD / ANGLE NYLON CAP 55011
					NEED A CUSTOM MADE TERMINAL? CALL US..... WE CAN HELP.
BASE STUD / SOLDERLESS BRASS FERRULE 55021	SOLDERLESS RING / SHORT CAP #10 HOLES 55101	SOLDERLESS RING / SHORT CAP .250 HOLE 55102	RING / SOLDERLESS BRASS FERRULE 55121	SOLDERLESS SPRING / SHORT NYLON CAP 55201	
					
SPRING / ANGLE NYLON CAP 55211	SPRING / SOLDERLESS BRASS FERRULE 55221	SPRING / EXTENDED NYLON CAP 55231	SOLDERLESS ANGLE SPRING / SHORT CAP 55301	ANGLE SPRING / SOLDERLESS BRASS FERRULE 55321	

**Terminal Packaging Note**

Please note that most of the terminal connectors listed on pages 70 through 71 are packaged in 10 and 50 packs.  
  
 To order a 10 pack simply add the suffix -10 after the 5 digit part number.  
 For a 50 pack add a -50.

**Part Number: TCK - 1**

Transformer contact kit  
**Packaging:** Poly bag & tagged  
**Includes:**  
 2 - 45580 Contact buss bar clips  
 2 - 60010 #10 Split lock washer  
 2 - 60999 #10 Flat washer  
 2 - 60022 10-32 Hex nut  
  
 Can be used in a variety of applications and equipment.





**Solderless Wire Terminals & Kits**

**Section 4 - Electrical**

 <b>P/N: 61850</b> #6 RING TERMINAL 22-18 WIRE SIZE 4-6 STUD SIZE	 <b>P/N: 61854</b> #8 RING TERMINAL 22-18 WIRE SIZE 8 STUD SIZE	 <b>P/N: 61855</b> #10 RING TERMINAL 22-18 WIRE SIZE 10 STUD SIZE	 <b>P/N: 61856</b> #6 RING TERMINAL 16-14 WIRE SIZE 4-6 STUD SIZE	 <b>P/N: 61857</b> .250 RING TERMINAL 22-18 WIRE SIZE 1/4" STUD SIZE	 <b>P/N: 61858</b> #10 RING TERMINAL 16-14 WIRE SIZE 10 STUD SIZE
 <b>P/N: 61859</b> #6 SPADE TERMINAL 22-18 WIRE SIZE 4-6 STUD SIZE	 <b>P/N: 61861</b> #10 SPADE TERMINAL 22-18 WIRE SIZE 10 STUD SIZE	 <b>P/N: 61862</b> #6 SPADE TERMINAL 16-14 WIRE SIZE 4-6 STUD SIZE	 <b>P/N: 61863</b> .250 FEMALE TAB 22-18 WIRE SIZE .250 OD	 <b>P/N: 61864</b> #10 SPADE TERMINAL 16-14 WIRE SIZE 10 STUD SIZE	 <b>P/N: 61866</b> .250 MALE TAB 16-14 WIRE SIZE .250 X .032 SIZE
 <b>P/N: 61867</b> .250 MALE TAB 22-18 WIRE SIZE .250 OD	 <b>P/N: 61868</b> .250 FEMALE TAB 16-14 WIRE SIZE .250 ID	 <b>P/N: 61871</b> #8 RING TERMINAL 16-14 WIRE SIZE 8 STUD SIZE	 <b>P/N: 61872</b> .250 RING TERMINAL 16-14 WIRE SIZE 1/4" STUD SIZE	 <b>P/N: VBC1614</b> BUTT CONNECTOR 16-14 WIRE SIZE	 <b>P/N: VBC2218</b> BUTT CONNECTOR 22-18 WIRE SIZE

**Part Number:** 41881  
 Terminal Kit - "Big Box"  
**Packaging:** Sturdy Hinged Box  
**Includes:**  
 1 - Big Box containing all of the terminals listed on this page  
 Each compartment contains 50 each of the above terminal connectors that are the most popular in our industry.  
 1 - Each 40401 8mm/terminal crimping tool  
 3 - Each 6" long 1/8" fuel resistant shrink tube  
 3 - Each 6" long 1/4" fuel resistant shrink tube  
 And when you empty out a compartment just re-order using the above part numbers and add the suffix -50 and you are re-stocked in a snap! The heavy duty high impact case protects and organizes your parts for ease of use.

**NEW**  
**BIG BOX**







**Hi-Temp Wire Leads**

**Part Number:** 70043-02

Cable leads for Weil-McLain

**Packaging:** Poly bagged & tagged

**Includes:**

1 - Set of wire leads

Original OEM replacement leads for Weil-McLain models QB180 & 300. Weil-McLain P/N: 644-600-043. This lead features a .125 round female rod connector on one end and a 1/4" female spade connector on the other. Both crimped connections are protected by a 1" long oil resistant shrink tube.

**Specifications:**

- 11 3/4" Over all length
- 20KVDC
- 150° C / 302° F



**Part Number:** 70071

Cable leads for Honeywell

**Packaging:** Poly bagged & tagged

**Includes:**

1 - 7mm Wire lead per bag

Crown generic replacement for Honeywell #:392125-2

These hi-temp rated leads offer a 90° automotive type connector on one end and a straight automotive type connector on the other end.

**Specifications:**

- 36" Over all length - 18 AWG - 25KVDC / 10KV / 60 HZ - 250° C / 482° F - UL FILE: E-96824 - UL STYLE: 3257



**Part Number:** 70070

Cable leads for Honeywell

**Packaging:** Poly bagged & tagged

**Includes:**

1 - 7mm Wire lead per bag

Crown generic replacement for Honeywell #:394800-30.

These hi-temp rated leads offer a 90° automotive type connector on one end and a 1/4" female insulated tab on the other end.

**Specifications:**

- 30" Over all length - 18 AWG - 25KVDC / 10KV / 60 HZ - 250° C / 482° F - UL FILE: E-96824 - UL STYLE: 3257



**Part Number:** 70072

Cable leads for Honeywell

**Packaging:** Poly bagged & tagged

**Includes:**

1 - 7mm Wire lead per bag

Crown generic replacement for Westwood #:E64-5

These hi-temp rated leads offer a 90° automotive type connector on one end and a straight automotive type connector on the other end.

**Specifications:**

- 33 1/2" Over all length - 18 AWG - 25KVDC / 10KV / 60 HZ - 250° C / 482° F - UL FILE: E-96824 - UL STYLE: 3257







**Twisted Rope - High Temp.**

Our ceramic fiber rope is a twisted three-ply rope made to meet tough industrial standards, **2300 degrees fahrenheit (1260 degrees centigrade)**. Typical uses include gasketing, packing and sealing applications. Our rope exhibits excellent chemical stability, resisting attack from most corrosive agents. Exceptions are Hydrofluoric and Phosphoric acids and concentrated alkalis. They also resist Oxidation and Reduction. If wet by water or steam, thermal and physical properties are completely restored upon drying. No water hydration is present.

**Ceramic High Temperature Asbestos Free Twisted Rope**



DIA	FT / CARTON	P/N
1/4"	45'	14FR45
1/4"	90'	14FR90
1/4"	900'	14FR900
3/8"	25'	38FR25
3/8"	50'	38FR50
3/8"	500'	38FR500
1/2"	15'	12FR15
1/2"	30'	12FR30
1/2"	300'	12FR300
5/8"	Sold per foot	58FR
3/4"	Sold per foot	34FR
1"	Sold per foot	1FR
1 1/4"	Sold per foot	114FR
1 1/2"	Sold per foot	112FR
2"	Sold per foot	2FR

**Braided Rope - High Temp.**

Our ceramic fiber braided rope is a tightly knitted braid that keeps it's form under the most extreme applications. It won't unravel or flatten and is easy to cut.

**Constant operating temperature of 2300 degrees fahrenheit (1260 degrees centigrade)**. Typical uses include gasketing, packing and sealing applications. Our rope exhibits excellent chemical stability, resisting attack from most corrosive agents. Exceptions are Hydrofluoric and Phosphoric acids and concentrated alkalis. They also resist Oxidation and Reduction.

**Ceramic High Temperature Asbestos Free Braided Rope**



DIA	FT / CARTON	P/N
1/4"	45'	14FRB45
1/4"	90'	14FRB90
1/4"	900'	14FRB900
3/8"	15'	38FRB15
3/8"	25'	38FRB25
3/8"	400'	38FR400
1/2"	15'	12FRB15
1/2"	30'	12FRB30
1/2"	300'	12FRB300
5/8"	Sold per foot	58FRB
3/4"	Sold per foot	34FRB
1"	Sold per foot	1FRB
1 1/4"	Sold per foot	114FRB
1 1/2"	Sold per foot	112FRB
2"	Sold per foot	2FRB



## Fiberglass Tape

**Part Number(s):**  
 FG1X116A (1" W X 1/16" T X 100' Roll w/adhesive)  
 FG1X18 (1" W X 1/8" T X 100' Roll)  
 FG1X18A (1" W X 1/8" T X 100' Roll w/adhesive)  
 FG1X14 (1" W X 1/4" T X 100' Roll)  
 FG1X14A (1" W X 1/4" T X 100' Roll w/adhesive)  
 FG112X18 (1 1/2" W X 1/8" T X 100' Roll)  
 FG112X18A (1 1/2" W X 1/8" T X 100' Roll w/adhesive)  
 FG112X14 (1 1/2" W X 1/4" T X 100' Roll)  
 FG112X14A (1 1/2" W X 1/4" T X 100' Roll w/adhesive)  
 FG2X18 (2" Wide X 1/8" Thick X 100' Foot Roll)  
 FG2X18A (2" W X 1/8" T X 100' Roll w/adhesive)  
 FG2X18BH (2" W X 1/8" T X 100' W with bolt holes)

Fiberglass tape

**Packaging:** Shrink wrapped - 100' roll.

**Includes:**  
 1 - 100' roll of one of the above selected sizes.  
 Flex-Tape has a **temperature rating of 1000° F (538° C)**.  
 Flex-Tape is a knitted fiberglass tape manufactured from textured fiberglass yarn. It contains no compounds, cement, or wire. The knitting process includes a non-fraying edge.

**Applications include:**  
 Used in ovens, furnaces and boilers as a door seal, as pipe wrapping in such applications as steam tracer lines, as tadpole tape gasket covering material, and in many other gasket and insulation applications.



**Part Number (s):**  
 48001 - 1' x 50' roll  
 48002 - 2' x 50' roll  
 48004 - 3' x 50' roll  
 48006 - 4' x 50' roll

Fiberfrax® 440J gasket paper

**Packaging:** Plain corrugated carton

**Includes:**  
 1 - roll of 1/8" thick 440J gasket paper of selected size.  
 Fiberfrax® 440J paper is a commercial grade, paper made from a combination of ceramic fiber, inert fillers and fiberglass to produce an exceptionally strong sheet for use up to 704 degrees Centigrade/1300 degrees Fahrenheit. Ideal for gasketing applications. Its easy to handle and can be cut, wrapped and rolled.



## Ceramic Fiber Blankets

**Part Number(s):**  
 48015 (1/2" T X 24" W X 25' L)  
 48016 (1/2" T X 48" W X 25' L)  
 48017 ( 1" T X 24" W X 25' L)  
 48018 ( 1" T X 48" W X 25' L)  
 48019 (1 1/2" T X 24" W X 17' L)  
 48020 (1 1/2" T X 48" W X 17' L)  
 48021 (2" T X 24" W X 12 1/2' L)  
 48022 (2" T X 48" W X 12 1/2' L)  
 48023 (1" T X 24" W X 25' L Zirconia Grade)  
 48024 (1" T X 48" W X 25' L Zirconia Grade)

Ceramic fiber blanket

**Packaging:** Carton

**Includes:**  
 1 - roll of one of the above selected sizes.  
 Our TaoFibre® Ceramic Fiber Blankets are spun ceramic fiber blanket, which are lightweight and thermally efficient, resulting in a material that possesses the advantages of low heat storage and complete resistance to thermal shock. Used in a variety of heat processing applications, the ceramic fiber blanket is produced from high strength spun ceramic fibers and is needed to provide exceptional handling strength. The ceramic fiber blanket is completely inorganic and is available in a variety of thicknesses, and widths. Our blankets are comparable to Durablanket® S & HP-S and our Zirconia grade is comparable to Durablanket® 2600. All of our blankets have an average tensile strength of 8 pcf. density (11.60 psi).  
 Part # 48015 to 48022 **max. temp.rating 2300° F (1260° C)**.  
 Part # 48023 to 48024 **max. temp.rating 2600° F (1426° C)**.  
**NOTE:** UPS up-charge applies due to carton dimensions.

**Applications include:**

- Furnace, klin, and boiler linings
- Casting mold wrappings
- Flexible high-temperature pipe insulation
- Furnace door linings and seals
- Furnace repairs
- Expansion joint seals
- Wrapping insulation





**Part Number(s):**

- 48101 ( 12 per case 1/2" Tk. X 2' X 3' LD) \*
- 48102 ( 6 per case 1" Tk. X 2' X 3' LD)
- 48103 ( 4 per case 1 1/2" Tk. X 2' X 3' LD)
- 48104 ( 3 per case 2" Tk. X 2' X 3' LD)
- 48105 ( 4 per case 1" Tk. X 2' X 4' LD)
- 48106 ( 6 per case 1/2" Tk X 3 1/2' X 4' LD)
- 48107 ( 8 per case 1/2" Tk X 2' X 4' LD)
- 48108 ( 2 per case 2" Tk X 2' X 4' LD)
- 48125 ( 24 per case 1/4" Tk. X 2' X 3' HD)
- 48131 ( 12 per case 1/2" Tk X 2' X 3' HD)

Refractory boards

**Packaging:** Corrugated carton

**Includes:**

1 case of LD or HD fiberboards from the above list.  
 Our TaoFibre® high temperature ceramic fiber boards feature high temperature stability, low thermal conductivity, even density, and excellent resistance against thermal shock and chemical attack. TaoFibre® ceramic fiber board also resists oxidation and reduction. If they are wet by water, steam, or oil, physical and thermal properties are fully restored upon drying. Ceramic Fiber board is used for a variety of high temperature applications, including refractory linings, backup insulation, baffles and muffles, heat shields, combustion chambers, flue insulation, and fire protection. These ceramic fiber boards are low density for easy cutting and have a continuous temperature rating of 2300° F / 1260° C.

\*NOTE: This item must ship via UPS Freight service to prevent shipping damage, or freight disclaimer signature required.

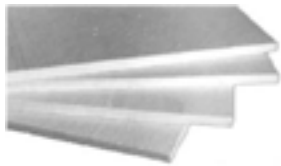

**Original replacement gaskets for Beckett, Carlin, & Wayne burners**

The below gaskets are the original OEM gaskets for the below specified burners.

Guaranteed to work in the application! For gasket specifications please contact the OEM directly.

**Part Number:** 100428

Wayne flange gasket HS HSR HSG

**Dimensions:** 7 1/2" OD X 4" ID

**Used in models:** HS, HSR, & HSG



**Part Number:** 12484

Wayne flange gasket EH EASR EHA

**Dimensions:** 7 3/8" OD X 4 5/16" ID

**Used in models:** EH, EASR, & EHA



**Part Number:** 3616

Beckett flange gasket - Universal

**Dimensions:** 8 1/2" OD X 3 15/16" ID

**Used in models:** Universal



**Part Number:** 3811

Beckett flange gasket #68 W-M Boilers

**Dimensions:** 6 1/4" L X 6 1/4" W

**Used in models:** Used in #68 Weil-McLain boilers.



**Part Number:** 5432

Beckett flange kit AF,AFG,SR,SF, & SMG

**Packaging:** Poly bagged & tagged

**Includes:** 1 ea. Flange & 1 ea. Gasket (3616)

Fits models AF,AFG,SR,SF, & SMG.



**Part Number:** 75016

Carlin flange gasket #40287

**Dimensions:** 8" OD X 3 1/8" ID

**Used in models:** 99-101 CRD, G3 & EZ1



**Part Number:** 70203 - 11 oz. caulking tube

Ceramic putty - Thermeez®

**Packaging:** Bulk

**Includes:**

1 - 11 oz. tube of Thermeez ceramic putty  
 Thermeez is made of a high purity, asbestos free, aluminum oxide based ceramic with a melting point in excess of 3200° F. **It has a continuous service temperature of 3000° F.** Use for instant repairs to brick, mortar, burner blocks, insulation, furnace holders, thermocouples, etc...just apply and let dry!. Resistant to molten metals, most chemicals, oxidizing, and reducing atmospheres.  
 Cures in 24 hours at room temperature. Drying process can be accelerated by using a heat gun for emergency repairs. This product has a 8 - 12 month shelf life.

**Properties**

- Base.....AL203
- Loss factor.....0.017
- Continuous service.....3000°F
- Melting point.....3200°F
- Density.....40 - 50#/ft.<sup>3</sup>
- Specific heat.....0.25 BTU/#°F
- Dielectric constant @ 10<sup>3</sup> CPS.....1.61
- Dielectric strength.....100 volts/mil.
- Freezing point.....32°F
- Thermal conductivity\*.....0.65
- \*BTU/Hr.°F ft. @ 500°F





## Burner Gaskets - Assorted

We make a wide variety of generic gaskets for a variety of burners. These gaskets are made of a 1/8" thick white non-asbestos material and have a continuous operating temperature of 2300 degrees fahrenheit.

**Part Number:** 75000  
 Miller large pouch gasket  
**Dimensions:** 16"L X 10 1/2"W  
**Used in models:** CMF, MOC, & MGC  
 Miller #: 301205000



**Part Number:** 75007  
 Universal gasket - No bolt holes  
**Dimensions:** 8"OD X 4"ID  
**Used in models:** Universal



**Part Number:** 75001  
 Miller small pouch gasket  
**Dimensions:** 13 5/8"L X 10"W  
**Used in models:** MMG82  
 Miller #: 301181000



**Part Number:** 75008  
 Utility gasket roll  
**Dimensions:** 25 Ft. X 1" Wide  
**Used in models:** Universal



**Part Number:** 75002  
 Miller burner flange gasket  
**Dimensions:** 6 1/2"OD X 4 1/4"ID  
**Used in models:** CMF, & MOC  
 Miller #: 300001000



**Part Number:** 75009  
 Carlin flange gasket 1150  
**Dimensions:** 12"OD X 10"ID  
**Used in models:** 1150



**Part Number:** 75003  
 Riello air tube gasket  
**Dimensions:** 5 1/4"L X 5 1/4"W  
**Used in models:** Universal

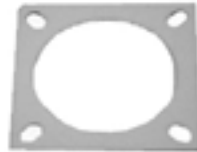

**Part Number:** 75010  
 Carlin flange gasket 1050  
**Dimensions:** 11"OD X 8 3/4"ID  
**Used in models:** 1050



**Part Number:** 75004  
 Thermo Pride cover gasket  
**Dimensions:** 4"OD X 3/8"ID  
**Used in models:** Universal



**Part Number:** 75011  
 Carlin flange gasket 801 PF  
**Dimensions:** 11"OD X 5 1/4"ID  
**Used in models:** 801 Pressure fired



**Part Number:** 75005  
 G. E. Door Gasket  
**Dimensions:** 10"OD X 8"ID  
**Used in models:** Universal



**Part Number:** 75012  
 Carlin flange gasket 201-701 CRD  
**Dimensions:** 10"OD X 4 1/8"ID  
**Used in models:** 201, 301, 501,  
 601 & 701 Pressure fired CRD



**Part Number:** 75006  
 Cover gasket - Heil / Bradford / Olsen  
**Dimensions:** 3"OD X 2"ID  
**Used in models:** Universal



**Part Number:** 75013  
 Carlin flange gasket 801 STD  
**Dimensions:** 8 1/2"OD X 5 1/4"ID  
**Used in models:** 801 STD







**Part Number:** 75014  
 Carlin flange gasket 40246  
**Dimensions:** 8 1/2"OD X 4 1/8"ID  
**Used in models:** 501, 601 & 701 STD



**Part Number:**  
 FC30-1005 (11oz. Caulk tube)  
 FC30-1040 (1 gal. Pail)  
 DO-ALL+ Furnace cement  
**Packaging:** Bulk



**Includes:**  
 1 - each of the above part numbers  
 Cures in 24 hours. Rated at 3000 degrees F. Will not shrink, pull away, crack, sag, run out of joint or lose sealing properties. Not harmed by freezing and thawing  
 Used in cementing & resetting furnaces, boilers, stoves, chimney collars, sealing flue pipes, cementing & bedding of fire brick, boards and combustion chambers.

**Part Number:** 75015  
 Carlin flange gasket 40287  
**Dimensions:** 8 1/4"OD X 4 1/8"ID  
**Used in models:** 201 & 301 STD



**Part Number:** 75017  
 Miller flange gasket  
**Dimensions:** 12 13/16"L X 4 9/16"W  
**Used in models:** MSH / Miller #: 689505



- Part Number(s):**
- FR1-10 (1" DIA. X 10' Long)
  - FR1-25 (1" DIA. X 25' Long)
  - FR1-160 (1" DIA. X 160 Long)
  - FR112-100 (1 1/2" DIA. X 100' Long)
  - FR114-100 (1 1/4" DIA. X 100' Long)
  - FR12-10 (1/2" DIA. X 10' Long)
  - FR12-25 (1/2" DIA. X 25' Long)
  - FR12-550 (1/2" DIA. X 550' Long)
  - FR14-10 (1/4" DIA. X 10' Long)
  - FR14-25 (1/4" DIA. X 25' Long)
  - FR14-2600 (1/4" DIA. X 2600' Long)
  - FR34-10 (3/4" DIA. X 10' Long)
  - FR34-25 (3/4" DIA. X 25' Long)
  - FR34-280 (3/4" DIA. X 280' Long)
  - FR38-10 (3/8" DIA. X 10' Long)
  - FR38-25 (3/8" DIA. X 25' Long)
  - FR38-1000 (3/8" DIA. X 1000' Long)
  - FR58-10 (5/8" DIA. X 10' Long)
  - FR58-25 (5/8" DIA. X 25' Long)
  - FR58-350 (5/8" DIA. X 350' Long)



**Part Number:** 75018  
 Miller flue gasket  
**Dimensions:** 7 1/8"OD X 5 1/8"ID  
**Used in models:** CMF, MOC & MGC  
 Miller #: 301195000



**Part Number:** 75019  
 Miller gasket kit  
**Includes:**  
 1 - 75000 (Miller # 301205000)  
 1 - 75001 (Miller # 301181000)  
 1 - 75002 (Miller # 300001000)  
 1 - 75018 (Miller # 301195000)  
**Used in models:** CMF, MOC, & MGC



**Part Number:** 75020  
 Carlin gasket kit  
**Includes:**  
 5 - 75016 Carlin #40287  
 1 - 75009 (Model 1150)  
 1 - 75010 (Model 1050)  
 1 - 75011 (Model 801 PF)  
 1 - 75012 (Model 301-701 PF)  
 1 - 75013 (Model 801 STD)  
 1 - 75014 (Model 501-701)  
 1 - 75015 (Model 201 & 301)  
**Used in models:** 99-101 CRD, EZ1, 1150, 1050, 801 PF, 301,501, 601, & 701 PF, 801 STD, 501, 601, & 701 STD, 201 & 301 STD.

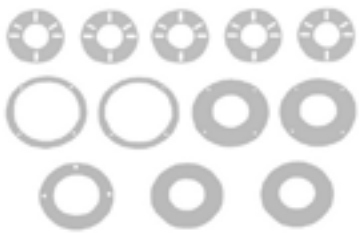

**Knit braided fiberglass rope**  
**Packaging:** Boxed  
**Includes:**  
 1 - each of the above parts listed  
 Our knit-braided fiberglass rope is manufactured to give superior qualities to high-temperature rope without the hazards associated with outdated materials. Flex-Rope resists temperatures up to 1000° F (538° C) Because of the special knit-braided process, it is available in a variety and densities.

**Features and Benefits:**  
 Flex-Rope is extremely strong, resilient, and flexible. The special knit-braided process enables Flex-Rope to spring back to its original shape after compression, making it an excellent choice for gasketing that acts as a heat break or door seal. Used as gasketing for industrial ovens and furnaces, boilers and wood burning stoves. Makes an excellent core for tadpole tape gasketing.

**Section 5 - Refractories & Gaskets**



## TROUBLE SHOOTING GUIDELINES

### **1. Work safely:**

Always bring a fire extinguisher with you to the heater location, and always check the combustion chamber for raw fuel!. Do not fire a burner with a loaded chamber. Clean it up first. Better to be safe than sorry.

### **2. Talk to the customer:**

Find out as much as you possibly can about the operating condition of the equipment prior to the service call. Ask if the furnace has been recently serviced, when was the last time it was cleaned, when was the last oil delivery, etc.

These types of questions can be valuable clues that may help determine why the equipment failed to operate.

### **3. Set the room thermostat:**

Set for "HEAT," and raise the set point to its maximum setting.

### **4. Stick the tank:**

This may seem like a waste of time (especially if the customer claims that they "just got a delivery the other day."), but it is a good habit to get into. I have wasted many hours over the years trying to get fuel units to pick up oil from empty tanks that were, "filled yesterday."

### **5. Now you are ready to begin working on the furnace itself:**

Turn off the power switch and check the combustion chamber if you have not already done so. Clean up any raw fuel. The presence of raw fuel would be a good indication that there is oil up to the nozzle and that the problem lies somewhere in the ignition system. If the chamber is dry, feel the supply plenum (on forced air systems) or the water pipes (on boilers). In either case, they will be cold if the system has been down for any length of time. If they are hot to the touch, check to see if the equipment has shut down due to limit opening.

Likely problem areas would be an inoperative blower motor, dirty filters, or perhaps a bad circulator.

### **6. At this point you have been on the job site for about five minutes and may have already located the problem area:**

If not, push the reset button on the primary control or stack switch. Make sure you have your fire extinguisher handy (just in case) and develop the habit of standing clear of the draft regulator and inspection port.

One of three things will happen. The burner motor will start and the burner will fire, the burner motor will start and the burner will not fire, or nothing at all happens.

### **7. If there is no response when pushing the reset, there is some sort of electrical problem with the equipment:**

Use a voltmeter and confirm that there is voltage (usually 120 volts) to the primary control or stack switch. Disconnect the wires from the "T - T" terminals and jumper T to T on the control.

One a primary control, disconnect one of the yellow wires from the cad cell eye. Ambient light, a shorted eye, or a short in the wires from the cad cell will keep the burner from firing.

On stack controls, "step" the contacts by gently pulling and releasing the drive shaft. Try carefully jumping out the cold contacts.

Push the reset button on the burner motor, it may have tripped. At some point either the burner will fire or you will find the problem.

### **8. If the burner starts, but does not fire, turn it off after 10 seconds of operation:**

Allowing the burner to run until the safety trips, may load the chamber with excess oil.

Disconnect the jet line (the line that connects the fuel unit to the nozzle line) from the nozzle line and direct it into a clear container.

Take enough oil (several ounces) so you can observe the sample for water or other contamination.

Install an oil pressure gauge in the nozzle line and check the pressure. On most systems the pressure should be set at 100 psi.

### **9. No oil at the jet line indicates some sort of delivery problem:**

Check the coupling and confirm that the fuel unit drive shaft is turning.

Check vacuum. Very high vacuum indicates a restriction (or possibly a very long distance to the tank). No vacuum may indicate an air leak if the tank is below the burner.

Remove the side cover from the pump. Excessive dirt will require that the pump screen is cleaned and the pump may have to be replaced.

### **10. Good oil delivery at 100 psi and a clean oil sample indicates that the problem is in the oil burner itself:**

Check the nozzle, the transformer, and the electrodes. The problem is somewhere in this area.

### **Conclusion:**

These steps will allow you to work on any oil burner system with confidence. When working on any furnace, boiler, or mechanical system always look for logical procedures to follow that will allow you to quickly eliminate the unlikely areas and get right to the problem.

Reproduced by special permission of: **Oilheating Magazine.**



**Part Number:** KK100  
 Burner coupling - KK100 kit  
**Packaging:** Carded w/hanger knockout  
**Includes:**  
 Coupler assembled with 1/2" motor shaft end, and a 5/16" fuel unit shaft cap on the other. A 7/16" fuel unit shaft end cap is also enclosed. Over-all 5" assembled coupler length.



**Part Number:** KK400  
 Burner coupling - Ultra KK400  
**Packaging:** Flambeau utility box  
**Includes:**  
 The Ultra Coupling Kit provides everything the service technician needs for instant, on-the-job burner coupling repair and replacement. Packaged in a sturdy tool box. Each kit contains:  
 10 - 12" length coupler shaft tubing  
 24 - 1/2" end caps - grey  
 16 - 5/16" end caps - green  
 8 - 7/16" end caps - orange  
 2 - 5/8" end caps - blue  
 2 - 3/8" end caps - yellow  
 1 - Torrington adapter  
 1 - Handi-Kutter tool  
 1 - 10 pk. repl. blades for Kutter  
 1 - Instruction sheet



**Part Number:** KK100B-06  
 Burner couplings - KK100 - Bulk 6/pk.  
**Packaging:** Poly bagged & tagged  
**Includes:**  
 6 - KK100 Couplers assembled with 1/2" motor shaft end cap, and a 5/16" fuel unit end cap on the other. Also includes 6 - 7/16" end caps. This kit will meet most coupler replacement needs. Over-all 5" assembled coupler length.

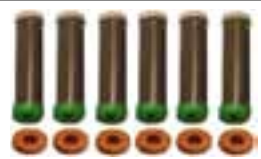

**Part Number:** KK112  
 Burner coupling - KK112 kit 12/pk  
**Packaging:** Boxed in attractive carton  
**Includes:**  
 Everything needed to replace almost any defective domestic burner coupler.  
 12 ea. 6" x 1" OD assembled couplers with 1/2" and 5/16" end caps. (Over-all 6" coupler length)  
 4 ea. 1/2" motor end caps  
 8 ea. 7/16" pump end caps  
 3 ea. 5/16" pump end caps



**OEM Ready Fit Couplers**

- Ready to use on the most popular burners
- No cutting or fitting necessary
- Strong and lightweight
- 12 assembled couplers per box
- Unaffected by humidity
- Unaffected by oil and most chemicals
- Made in the U.S.A.
- Reliable



Our Pioneer brand OEM couplers are cut to the exact size for the below listed OEM models. A great way to save time on tune-ups and quick repairs.

Part Number	OEM Name	OEM Model
KK500B	Beckett	2454
KK500C	Carlin	201 - 301 CRD
KK500CA	Carlin	99RJE, 1020J, CRD 98-102
KK500CA-1	Carlin	1020 Mini pump
KK500W	Wayne	13279
KK500WA	Wayne	100386
KK500WM	Weil-McLain	QB180 & QB300

**NOTE:** Custom lengths are available to quote

**Part Number:** KK120  
 Burner coupling - KK120 kit  
**Packaging:** Carded w/hanger knockout  
**Includes:**  
 Coupler assembled with 1/2" motor shaft end cap on one side, and a 1/2" fuel unit shaft on the other. 5" over-all coupler length. Other end cap sizes include 5/8", 7/16", 3/8", and 5/16".







## Burner Couplings - Bulk

Our coupler tubing is made of the same ridged urethane tubing used in our popular KK100 coupler kits. Great for making your own custom lengths.



Part Number	Tube OD	Tube Length
1T06	1"	6"
1T12	1"	12"
1T15	1"	15"
1T36	1"	36"

## Burner Coupling End Caps

### Bulk Pioneer Coupling End Caps

Our super strong plastic end caps are tough. Built to take high torque, shock starts, and stops.



Part Number	Shaft Size	Color Code
5/16	5/16	Green
3/8	3/8	Yellow
7/16	7/16	Orange
1/2	1/2	Gray
5/8	5/8	Blue

**Part Number:** HK  
 Handi-Kutter - Pioneer coupling cutter  
**Packaging:** Boxed in attractive carton  
**Includes:**  
 The Pioneer Handi-Kutter comes fully assembled and ready to serve all your coupler cutting needs.



**Part Number:** 1T06A  
 Burner coupling kit - replaces WW#: S85-510  
**Packaging:** Poly bagged & tagged  
**Includes:**  
 This coupler packaging style rivals WW kit #:99A or S85-510  
 1 - 6" koupling shaft  
 2 - 1/2" end caps  
 2 - 7/16" end caps  
 1 - 5/16" end caps



**Part Number:** 1T06B  
 Burner coupling kit - replaces WW#: S85-520  
**Packaging:** Poly bagged & tagged  
**Includes:**  
 This coupler packaging style rivals WW kit #:101 or S85-520  
 1 - 6" coupling shaft  
 2 - 1/2" end caps  
 1 - 7/16" end caps  
 2 - 5/16" end caps



**Part Number:** HKB-10  
 Handi-Kutter replacement blades  
**Packaging:** Plastic container  
**Includes:**  
 10 - stainless steel replacement blades. These blades are razor sharp, so please use caution when handling them. Blades are easy to install. Using a #2 flat screw driver remove screws holding existing blade, remove old blade, position new blade with sharp edge facing the cutting area, and secure in place with screws previously removed.



**Part Number:** TA  
 Splined Hub-Adapters  
**Packaging:** Bulk  
**Includes:**  
 Four designed splines within the Hub provide for sure gripping action for quick starts. Specifically designed for use with Torrington Blowers. Dimension are: 1" Hub Length, 1 1/8" Hub ID, 1 1/4" Hub OD, 11/16" L X 1/2" OD male connector 1 11/16" Over-all length



**Part Number:** KK100HK  
 Burner coupling & Handi-Kutter kit  
**Packaging:** Poly bagged & tagged  
**Includes:**  
 Coupler assembled with 1/2" motor shaft end, and a 5/16" fuel unit shaft cap on the other. A 7/16" fuel unit shaft end cap is also enclosed. Over-all 5" assembled coupler length. Our Handi-Kutter coupling cutter is also included.







**Spring / Coiled Circulator Couplers**

<b>Part Number: 10010</b>	
<p><b>Description:</b>                  Spring coupler - 10010  <b>Bore size:</b> 1/2 X 1/2 <b>OAL:</b> 1 5/16"  <b>HP Range:</b> 1/12 to 1/3 HP  <b>Rotation:</b> CCW  <b>Fits B &amp; G:</b> 118705, 189110, 118723, 118705, &amp; 189110.  <b>Fits Armstrong:</b> 806026, 806168 &amp; 806026.</p>	

<b>Part Number: 10023</b>	
<p><b>Description:</b>                  Spring Coupling - 10023  <b>Bore size(s):</b> 1/2 X 1/2 or 1/2 X 5/8 <b>OAL:</b> 1 7/8"  <b>HP Range:</b> 1/2 to 3/4 HP  <b>Rotation:</b> CW  <b>Fits B &amp; G:</b> 118473, 118708 &amp; 188709.  <b>Fits Armstrong:</b> 807436 &amp; 806137</p>	

<b>Part Number: 10034</b>	
<p><b>Description:</b>                  Spring Coupling - 10034  <b>Bore size:</b> 5/8 X 5/8 <b>OAL:</b> 2 1/4"  <b>HP Range:</b> 1 HP  <b>Rotation:</b> CW  <b>Fits B &amp; G:</b> 118476 &amp; P77271.  <b>Fits Armstrong:</b> 812734 &amp; 816665.</p>	





<b>Part Number: 10045</b>	
<p><b>Description:</b>                  Spring Coupling - 10045  <b>Bore Size(s):</b> 1/2 X 1/2 or 1/2 X 5/8 or 5/8 X 5/8 <b>OAL:</b> 2 5/16"  <b>HP Range:</b> 1/4 to 1 HP  <b>Rotation:</b> CW  <b>Fits Taco:</b> 121, 122, 131, 132, 133, &amp; 138.  <b>Fits Woods:</b> 3J &amp; 4J</p>	

<b>Part Number: 70010</b>	
<p><b>Description:</b>                  Spring Coupling TACO  <b>Bore Size:</b> 1/2 X 3/8 <b>OAL:</b> 1 7/8"  <b>HP Range:</b> 1/12 to 1/3 HP  <b>Rotation:</b> CW  <b>Replaces:</b> 110-009RP</p>	

**NOTE:** Rotation listed is determined by viewing the motor with the shaft pointing away. Always check rotation prior to installing. If looking at pump shaft end reverse rotation.

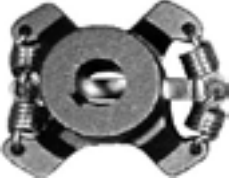

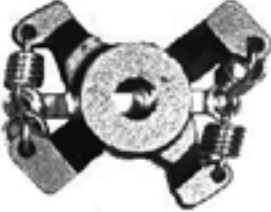
**B & G / Armstrong Circulator Couplers**

 41100	 41101	 41102
 41288	 41289	 *41299
<p>*Please note: We have replaced our old “zink” style coupling with our 41300 “cast iron” coupling and selling it under the old zink coupling part number of 41299. Please make note of this change.</p>		

Crown P/N	Armstrong P/N	B & G P/N	Bore Size ID	Type
41100	810120-008	186410	5/8" X 1/2"	Iron
41101	816665-000	118476	5/8" X 5/8"	Iron
41102	806168-001	118723	1/2" X 1/2"	Iron
41288	810120-006	118709	1/2" X 5/8"	Iron
41289	810120-003	118473	1/2" X 1/2"	Iron
41299	806026-001	118705	1/2" X 1/2"	Iron
41300	Now is P/N 41299.			

**Part Number:** 41285-12  
 Hydronic circulator lube oil - Extended Spout  
**Packaging:** Bottled and boxed  
**Includes:**  
 12 - 4 oz. bottles per case  
 A fine blend of hydronic circulator oil.  
 The oil contains oxidation and corrosion inhibitors for maximum protection. Each bottle features a telescoping spout when dripping oil is an issue and for dispensing ease in hard to reach locations.





## Woods Couplers & Rubber Sleeves

The Wood's Sure-Flex® coupler can be installed quickly and easily, because there are no bolts, gaskets, covers or seals. Alignment can be checked with a straightedge placed across the outside of the precision-machined flanges. The teeth of the sleeve lock into the teeth of the flanges without clamps or screws. There is no rubbing action of metal against rubber to cause wear. Couplings are not affected by abrasives, dirt, or moisture. This eliminates the need for lubrication or maintenance, provides clean, dependable, quiet performance.



### J - SERIES FLANGES

Type J flanges size 3 and 4 are manufactured of sintered carbon steel. The powdered metal manufacturing process provides high dimensional accuracy and uniform material properties for high strength. Size 5 and 6 are made of high strength cast iron.



### S - SERIES FLANGES

Type S flanges are die cast of high strength cast iron and all are finished bored to size for a slip on fit on a standard shaft.



They too can be used in combination with the standard JE rubber inserts.

All flanges are bored-to-size for a slip fit on standard shafts. Type J flanges can be used with sleeves of any construction except the Hytrel. Each flange has a key seat and one (1) set screw over the keyway.

Part Number	Description
41904	WOODS COUPLER 3J X 1/2
41939	WOODS COUPLER 3J X 3/4
41905	WOODS COUPLER 3J X 5/8
41903	WOODS COUPLER 4J X 1
41906	WOODS COUPLER 4J X 1/2
41926	WOODS COUPLER 4J X 3/4
41907	WOODS COUPLER 4J X 5/8
41915	WOODS COUPLER 4J X 7/8
41918	WOODS COUPLER 5J X 1
41919	WOODS COUPLER 5J X 1 1/8
41908	WOODS COUPLER 5J X 1/2
41931	WOODS COUPLER 5J X 15/16
41917	WOODS COUPLER 5J X 3/4
41909	WOODS COUPLER 5J X 5/8
41923	WOODS COUPLER 5J X 7/8
41929	WOODS COUPLER 6J X 1
41927	WOODS COUPLER 6J X 1 1/8
41930	WOODS COUPLER 6J X 1 3/8
41935	WOODS COUPLER 6J X 15/16
41941	WOODS COUPLER 6J X 3/4
41910	WOODS COUPLER 6J X 5/8
41928	WOODS COUPLER 6J X 7/8
41940	WOODS COUPLER 10J X 1 1/4

Part Number	Description
53340	WOODS COUPLER 5S X 1/2
53341	WOODS COUPLER 5S X 5/8
53342	WOODS COUPLER 5S X 3/4
53343	WOODS COUPLER 5S X 13/16
53344	WOODS COUPLER 5S X 7/8
53345	WOODS COUPLER 5S X 15/16
53346	WOODS COUPLER 5S X 1
53347	WOODS COUPLER 5S X 1 1/16
53348	WOODS COUPLER 5S X 1 1/8
53349	WOODS COUPLER 5S X 1 3/16
53350	WOODS COUPLER 5S X 1 1/4
53351	WOODS COUPLER 6S X 5/8
53352	WOODS COUPLER 6S X 3/4
53353	WOODS COUPLER 6S X 7/8
53354	WOODS COUPLER 6S X 15/16
53355	WOODS COUPLER 6S X 1
53356	WOODS COUPLER 6S X 1 1/16
53357	WOODS COUPLER 6S X 1 1/8
53358	WOODS COUPLER 6S X 1 13/16
53359	WOODS COUPLER 6S X 1 1/4
53360	WOODS COUPLER 6S X 1 5/16
53361	WOODS COUPLER 6S X 1 3/8
53362	WOODS COUPLER 6S X 1 7/16
53363	WOODS COUPLER 6S X 1 1/2
53364	WOODS COUPLER 6S X 1 5/8
53365	WOODS COUPLER 6S X 1 3/4
53366	WOODS COUPLER 6S X 1 7/8

**Section 6 - Burner & Pump Couplers**



## Woods Couplers & Rubber Sleeves

### S - SERIES FLANGES - CONTINUED

Part Number	Description
53368	WOODS COUPLER 7S X 3/4
53369	WOODS COUPLER 7S X 7/8
53370	WOODS COUPLER 7S X 15/16
53371	WOODS COUPLER 7S X 1
53372	WOODS COUPLER 7S X 1 1/16
53373	WOODS COUPLER 7S X 1 1/8
53374	WOODS COUPLER 7S X 1 3/16
53375	WOODS COUPLER 7S X 1 1/4
53376	WOODS COUPLER 7S X 1 5/16
53377	WOODS COUPLER 7S X 1 3/8
53378	WOODS COUPLER 7S X 1 7/16
53379	WOODS COUPLER 7S X 1 1/2
53380	WOODS COUPLER 7S X 1 5/8
53381	WOODS COUPLER 7S X 1 7/8
53383	WOODS COUPLER 8S X 7/8
53384	WOODS COUPLER 8S X 15/16
53385	WOODS COUPLER 8S X 1
53386	WOODS COUPLER 8S X 1 1/16
53387	WOODS COUPLER 8S X 1 1/8
53388	WOODS COUPLER 8S X 1 3/16
53389	WOODS COUPLER 8S X 1 1/4
53390	WOODS COUPLER 8S X 1 5/16
53391	WOODS COUPLER 8S X 1 3/8
53392	WOODS COUPLER 8S X 1 7/16
53393	WOODS COUPLER 8S X 1 1/2
53394	WOODS COUPLER 8S X 1 9/16
53395	WOODS COUPLER 8S X 1 5/8
53396	WOODS COUPLER 8S X 1 11/16
53397	WOODS COUPLER 8S X 1 3/4
53398	WOODS COUPLER 8S X 1 7/8
53399	WOODS COUPLER 8S X 1 15/16
53400	WOODS COUPLER 8S X 2 1/16
53401	WOODS COUPLER 8S X 2 1/8
53402	WOODS COUPLER 8S X 2 3/8

Flexible sleeves for Wood's Sure-Flex couplings are available in four materials (EPDM, Neoprene, Hytel and Urethane) and in three basic constructions. The most common ones being listed here.

J sleeves are molded EPDM rubber (E) or Neoprene (N). They are available in one-piece solid construction (JE, JN) or one-piece split construction (JES, JNS). These sleeves may be used in any Sure-Flex flange within a given size.



### JE - SERIES SLEEVES

Part Number	Description
41911	WOODS EPDM SLEEVE 3JE
41912	WOODS EPDM SLEEVE 4JE
41913	WOODS EPDM SLEEVE 5JE
41914	WOODS EPDM SLEEVE 6JE
41924	WOODS EPDM SLEEVE 7JE
41916	WOODS EPDM SLEEVE 8JE
41925	WOODS EPDM SLEEVE 9JE
41920	WOODS EPDM SLEEVE 10JE
41934	WOODS EPDM SLEEVE 11JE



### JES - SERIES SLEEVES

Part Number	Description
53203	WOODS EPDM SLEEVE-SPLIT 3JES
53204	WOODS EPDM SLEEVE-SPLIT 4JES
53205	WOODS EPDM SLEEVE-SPLIT 5JES
53206	WOODS EPDM SLEEVE-SPLIT 6JES
53207	WOODS EPDM SLEEVE-SPLIT 7JES
53208	WOODS EPDM SLEEVE-SPLIT 8JES
53209	WOODS EPDM SLEEVE-SPLIT 9JES
53210	WOODS EPDM SLEEVE-SPLIT 10JES





## Woods Couplers & Rubber Sleeves

These sleeves are of two-piece design with a retaining ring. They are available in EPDM (E). They may be used with any flange within a given size.



H (Hytre) sleeves, are designed for high-torque applications, transmit four times as much power as an equivalent EPDM or Neoprene sleeve.



### E - SERIES SLEEVES 2 PC WITH BAND

Part Number	Description
53170	WOODS EPDM SLEEVE 4E - 2 PC
53171	WOODS EPDM SLEEVE 5E - 2 PC
53172	WOODS EPDM SLEEVE 6E - 2 PC
53173	WOODS EPDM SLEEVE 7E - 2 PC
53174	WOODS EPDM SLEEVE 8E - 2 PC
53175	WOODS EPDM SLEEVE 9E - 2 PC
53176	WOODS EPDM SLEEVE 10E - 2 PC
53177	WOODS EPDM SLEEVE 11E - 2 PC
53178	WOODS EPDM SLEEVE 12E - 2 PC
53179	WOODS EPDM SLEEVE 13E - 2 PC
53180	WOODS EPDM SLEEVE 14E - 2 PC
53181	WOODS EPDM SLEEVE 16E - 2 PC

Available in one-piece solid construction or split construction. Hytre sleeves can be used only with S, C, and SC flanges. They cannot be used with J or B flanges or as direct replacements for EPDM or Neoprene sleeves.

### HS - SERIES SLEEVES - SPLIT

Part Number	Description
53211	WOODS HYTREL SLEEVE-SPLIT 6HS
53212	WOODS HYTREL SLEEVE-SPLIT 7HS
53213	WOODS HYTREL SLEEVE-SPLIT 8HS
53214	WOODS HYTREL SLEEVE-SPLIT 9HS
53215	WOODS HYTREL SLEEVE-SPLIT 10HS
53216	WOODS HYTREL SLEEVE-SPLIT 11HS
53217	WOODS HYTREL SLEEVE-SPLIT 12HS
53218	WOODS HYTREL SLEEVE-SPLIT 13HS
53219	WOODS HYTREL SLEEVE-SPLIT 14HS

### JN - SERIES SLEEVES

Part Number	Description
53183	WOODS NEOPRENE SLEEVE 3JN
53184	WOODS NEOPRENE SLEEVE 4JN
53185	WOODS NEOPRENE SLEEVE 5JN
53186	WOODS NEOPRENE SLEEVE 6JN
53187	WOODS NEOPRENE SLEEVE 7JN
53188	WOODS NEOPRENE SLEEVE 8JN



### H - SERIES SLEEVES

Part Number	Description
53220	WOODS HYTREL SLEEVE 6H
53221	WOODS HYTREL SLEEVE 7H
53222	WOODS HYTREL SLEEVE 8H
53223	WOODS HYTREL SLEEVE 9H
53224	WOODS HYTREL SLEEVE 10H
53225	WOODS HYTREL SLEEVE 11H
53226	WOODS HYTREL SLEEVE 12H
53227	WOODS HYTREL SLEEVE 13H
53228	WOODS HYTREL SLEEVE 14H



### JNS - SERIES SLEEVES - SPLIT

Part Number	Description
53190	WOODS NEOPRENE SLEEVE 3JNS
53191	WOODS NEOPRENE SLEEVE 4JNS
53192	WOODS NEOPRENE SLEEVE 5JNS
53193	WOODS NEOPRENE SLEEVE 6JNS
53194	WOODS NEOPRENE SLEEVE 7JNS
53195	WOODS NEOPRENE SLEEVE 8JNS



**NOTE:** Need a Dura-Flex or Love Joy coupling? We can get great deals on those items as well. Call for pricing. Standard lead-time is 3 working days ARO.

Section 6 - Burner & Pump Couplers



**Manufacturer Rep Listing**

<b>Firm Name</b>	<b>Contact</b>	<b>Territory Covered</b>
Contact Crown directly to: 1) To locate an authorized Crown dealer in your area. 2) If you are an OEM seeking parts for your ignition needs.  <b>Crown Engineering Corporation</b> P.O. Box 846 - Farmingdale, NJ 07727 Tel#: (800) 631-2153 / Fax#: (888) 645-7278 Website: www.crownengineering.com E-mail: sales@crownengineering.com	Mr. Mike Palmer	AZ - FL -NM - NY -Long Island - NYC, NY- South of Westchester County Upstate NY (North of Westchester Cty.) NJ-North, OH-Eastern - PA-Western - NC - SC - TN - WI -Eastern - WV
<b>ETC Sales Company</b> P.O. Box 235 - Paoli, PA 19301 Tel#: (610)296-3527 / Fax#: (610)640-4271 E-mail address: monsgwen@msn.com	Mr. Mons King	Delaware, Eastern Pennsylvania, Maryland, Virginia, Washington D.C., & Southern New Jersey
<b>Pilgrim Sales</b> 7 Pilgrim Road - Marblehead, MA 01945 Tel#: (781)639-8004 / Fax#: (781)639-1157 Cell#: (617)548-2813 E-mail: deangelo@pilgrimsales.net	Mr. Lennie DeAngelo	CT - MA - ME - NH - RI -VT
<b>R.A. Kaplan Inc.</b> 10814 Coldwater Road - Ft. Wayne, IN 46845 Tel#: (260)637-0676 / Fax#: (260)637-2996 Website: www.rakaplaninc.com E-mail: mkaplan@rakaplaninc.com	Mr. Mark Kaplan Mr. Maark Jones Mr. Kale Ericson Mr. Dan Corwin Ms. Stacy Kaplan Ms. Linda Shank Mr. Bob Kaplan Ms. Melissa Browning	Illinois Indiana Kentucky, Michigan Wisconsin (Eastern)
<b>Sales Engineers</b> 12909 Pioneer Trail - Eden Prairie, MN 55347 Tel#: (612) 944-0773 / Fax#: (612) 944-1073 Website: www.salesengineersinc.com E-mail: jdungan@salesengineersinc.com	Mr. Mike Dungan Mr Jim Dungan	Minnesota, North Dakota, South Dakota & Wisconsin (Western)
<b>TSS Associates Inc.</b> 19 Rustyville Road - Albany, NY 12211 Tel#: (518)621-7283 / Fax#: (518)375-7039 E-mail: support@tssassociatesinc.com Website: www.tssassociatesinc.com	Ms. Brigitte Grady Mr. Steve Grady Mr. Rich Sebast Mr. Don Knuth	Upstate NY - Westchester County

**Canadian Representative**

<b>Alltemp Products Co. Ltd.</b> 827 Brock Road South Pickering, Ontario - Canada L1W-3J2 Tel#: (905) 831-3311 / Fax#: (905) 831-1864 E-mail: sales@rotom.com Website: www.alltemp.ca	Mr. Richard Chalmers	Canadian stocking distributor - All Provinces
--	----------------------	---

**Worldwide Representative**

<b>Alex Bauer and Company</b> 2429 Vauxhall Road - Union, NJ 07083 Tel#: (908) 964-4042 / Fax#: (908) 688-6668 E-mail address: export@cs123.com Website: alexbauer.com	Mr. G. R. Leiz Mrs. Leslie O'Brien	Worldwide
--	---------------------------------------	-----------

REVISED 09/28/16



**Copper oil Lines - Mueller Streamline®**

Our oil lines are made of genuine Mueller Streamline® dehydrated and nitrogen purged sealed copper tubing. It is of a consistent dead soft temper, bright, and thoroughly dried. A cleaning and drying process removes moisture and contaminants and is manufactured in accordance with ASTM-B-280 and ANSI-B9.1 refrigeration industry standards. We do the field work for you...we cut, add flair nuts, flair each open end, & package. We offer a variety of lengths to meet your needs!



Crown P/N	Dimension	Form
40449	3/16" Dia. x 16" Long	Straight
40450	3/16" Dia. x 5" Long	Straight
40451	3/16" Dia. x 8" Long	Straight
40452	Weil McLain Oil line	644-000-064
40453	3/16" Dia. x 20" Long	Straight
40454	3/16" Dia. x 12" Long	Straight
40455	3/16" Dia. x 16" Long	Coiled
40456	1/4" Dia. x 16" Long	Straight
40457	1/4" Dia. x 16" Long	Coiled
40458	1/4" Dia. x 12" Long	Straight
40461	1/4" Dia. x 8" Long	Straight
40463	1/4" Dia. x 5" Long	Straight
40459	3/16" x 1/4" M/F	Reducer M/F
63454	#41 - 3/16 Standard	Flare nut
63456	#41 - 1/4 Standard	Flare nut

**Section 7 - Oil Handling, Gauges, & Smoke Bombs**

**Part Number: 40360**

Miller oil line kit

**Packaging:** Poly bagged & tagged

**Includes:**

- 1 - 13494 elbow adapter
- 1 - 40459 flare reducer
- 1 - 40361B 3/16" Dia. X 7" Long oil line
- 1 - 40362B 3/16" Dia. X 11" Long oil line
- 1 - Instruction sheet

This convenient kit has everything you need to update a variety of Wayne burners, as well as, Miller mobile gun furnaces equipped with power oil burners.



**Part Number: 40470**

Anti-Hum Device - Silent Flow

**Packaging:** Individually boxed

**Includes:**

- 1 - Silent flow with 1/2" adaptor spring.
- For use on all domestic type pressure atomizing oil burners. Silent flow includes a 1/2" adaptor for use with 1/2" Dia. copper tubing and an easy to follow instruction sheet. Simple to install and effective in reducing oil line noise.





**Part Number(s):**  
 41411-48 (Specs. 2 3/4" OD x 3/4" ID x 3" Long - 48/CS)  
 41411-12 (Specs. 2 3/4" OD x 3/4" ID x 3" Long - 12/CS)  
 41412-12 (Specs. 3 1/4" OD x 3/4" ID x 4" Long)  
 41416-48 (Specs. 2 3/4" OD x 1" ID x 3 5/8" Long - 48/CS)  
 41416-12 (Specs. 2 3/4" OD x 1" ID x 3 5/8" Long - 12/CS)  
 Oil Filters - Rayon type for 1A-25A  
**Packaging:** Poly bagged & corrugated carton  
**Includes:**  
 Rayon filter elements individually packaged with gaskets.  
 Dash numbers indicates number of filters per carton.  
 Our "CLEAN FLOW", Rayon filter is a solid one piece construction...no felt fibers, or strings to hamper the oil flow.

**41411 for use in**  
 Autoflo F-300  
 Federal A77  
 General 1A-25A  
 Sid Harvey XF-25/264  
 Unifilter 77  
 Westwood S-254

**41412 for use in**  
 Autoflo F-400  
 General 2A-700A  
 Sid Harvey XF-1  
 Unifilter 99  
 Westwood S-252

**41416 for use in**  
 Fulflo F-B4, AS-4, & B-4



**Characteristic's**

<b>Color</b>	White
<b>Surface Area, in<sup>2</sup></b>	52
<b>Volume, in<sup>3</sup></b>	12
<b>Firing Rate, GPH</b>	10
<b>Clean Press. Drop</b>	0.4
<b>Dirt Capacity, oz.</b>	1.4
<b>Ending Press. Drop</b>	10.00
<b>Filtration Depth</b>	Medium
<b>Micron Range</b>	25 to 50

**Part Number:**  
 41420-12 (Replaces General 2A-700A)  
 Oil Filters - Felt type 2A-700A  
**Packaging:** Individually bagged with gaskets  
**Includes:**  
 12 - Individual filters with gaskets.  
 Made for domestic fuel oils. Made of felt discs. This 40 micron rated filter removes impurities that might hamper the burner's operation.



**Part Number:** **Wool Brand Filters - Bulk**  
 41421-30 (Replaces Fulflo FB-10")  
 Oil Filters for Fulflo - String type  
**Packaging:** Bulk & corrugated carton  
**Includes:**  
 30 - Individual filters **WITHOUT** gaskets.  
 Made for domestic fuel oils. Made of all wool string. This 40 micron rated filter removes impurities that might hamper the burner's operation.



**FB-6 & FB-8 ARE NO LONGER AVAILABLE**

**Part Number:** **Wool Brand Filters - 6 Pk.**  
 41421-06 (Replaces Fulflo FB-10")  
 Oil Filters for Fulflo - String type  
**Packaging:** Poly bagged  
**Includes:**  
 6 - Individual filters **WITHOUT** gaskets.  
 Made for domestic fuel oils. Made of all wool string. This 40 micron rated filter removes impurities that might hamper the burner's operation.



**FB-6 & FB-8 ARE NO LONGER AVAILABLE**

**Part Number (s):**  
 41440 (individual filter)  
 41440-12 (case of 12 filters)  
 Wix oil filter elements #24104  
**Packaging:** Individually boxed  
**Includes:**  
 1 - boxed filter or  
 12 - boxed filters in a master carton.  
 Heating Units, Small Engines & Steam Jennies  
 This spin-on filter provides effective filtration for a number of applications. The steel housing is strong and durable while the paper filter element delivers a clean supply of fuel for faultless combustion.  
 UL Recognized strainer for #2 oil or lighter.



- Specifications:**
- Dimensions 4 1/2" Hgt. X 2 5/8" OD
  - Maximum flow rate is 6 GPH
  - Compact design
  - Micron rating is 10

**10 MICRON**







**Part Number(s):**  
 41415-48 (Case of 48 filters with gaskets)  
 41415-12 (Economy case of 12 filters with gaskets)  
 Oil Filters - String type for FB-4  
**Packaging:** Bagged w/gasket in corrugated carton  
**Includes:**  
 48 or 12 - Individual filters with gaskets.  
 Made for domestic fuel oils. Made of all wool string. This 40 micron rated filter removes impurities that might hamper the burner's operation. Replaces FB-4 elements.



**Part Number(s):**  
 41439 (Complete UL listed filter system - Individually Pkg.)  
 41439-06 (Complete UL listed filter system - 6 Pack)  
 Oil Filters UL - Quick Spin III  
**Packaging:** Individually boxed  
**Includes:**  
 1 - Individually boxed filter system or  
 1 - 6 pack of boxed filter system.  
 Our newly designed Quick Spin III™ filtration system is now better than ever! It's the filter style of the future with our new triple leak protection shell that is tin plated carbon steel, epoxy coated, and an internal plastic base to prevent rust-out bottoms that other comparable filters are prone to.  
 As always our triple leak protection filter head is made of casted aluminum and incorporates a post gasket seal, a ridged rim that grips the seal gasket, and an outter lip that encloses the entire unit...safety first! And don't forget the practical benefits like a flat bottom, so your can doesn't spill oil all around the floor.  
 Our wholesale distributor's like the flat bottom design because they stack easily and our kit variety means they can offer a wider range of filtering combinations to meet their customers needs.  
 To top it off our Quck Spin III™ filtration system is UL listed for use in the USA and Canada with superior 10 micron filtration that effectively removes rust, scale, and other microscopic impurities that might hamper burner operation.

**UL listed for use in USA and Canada**



UL file: MH25548  
 UL Style: 41439



UL file: MH25548  
 UL Style: 80000850

**Filter Characteristic's for 41439**  
 Canister type.....Carbon steel, tin plated & epoxy coated  
 Melting point.....1100°F  
 Certification.....UL & CUL Listed  
 Micron Rating.....10  
 Dimensions.....4 5/8" H x 3 7/16" DIA  
 Rated flow rate.....25 USgph  
 Filtering area.....550 square inches  
 Rated work psi.....12 P.S.I.  
 Filtering media.....Resin treated cellulose  
 Rated work temp.....Up to 140°F  
 Max. working psi.....35 P.S.I.

UL file number.....MH 25548  
 UL Style.....41439

**Our 41439 Filter Replaces or fits:**

- Crown:** Quick-Spin I & II
- Garber:** 11V-R
- Mitco:** 290M and 264-91M
- Nozzle Guard:** NG-3300-G
- Sid Harvey:** 290-6 and 264-91
- Westwood:** F100-10
- Wix:** 24100



**Part Number(s):**  
 41436 (Individually boxed element w/gasket)  
 41436-06 (6 pack of individually boxed element w/gasket)  
 Oil Filter - QS III element only  
**Packaging:** Individually boxed w/gasket & 6/pack ctn.  
**Includes:**  
 1 - Individually boxed filter element with gasket or  
 6 - Individual boxed filter elementd with gasket in carton  
 Designed for superior filtration, 10 micron!  
 Our Quick Spin III™ replaces Gar-Ber's® R cartridge and mounts on existing Gar-Ber® heads, or you can use our own (see part number 41437).

**Section 7 - Oil Handling, Gauges, & Smoke Bombs**



**Part Number:** 41436K  
 Oil Filter UL - Quick Spin III - Complete kit #1

**Packaging:** Individually boxed  
**Includes:**

- 1 - Filter element
- 1 - Mounting head
- 1 - Mounting bracket with hardware
- 1 - Vacuum gauge 0 - 30 hg, 1/8" NPT



 UL file: MH25548  
 UL Style: 41439

**Part Number:** 41439-06  
 Oil Filter - QS III element with head

**Packaging:** Individually boxed in carton  
**Includes:**

6 - filter elements with 6 head mounts & post gaskets  
 Effectively removes rust, scale and other microscopic impurities that might hamper the burner's operation.



**X 6**

 UL file: MH25548  
 UL Style: 41439

**Part Number:** 41436G  
 Oil Filter UL - Quick Spin III - kit #2

**Packaging:** Individually boxed  
**Includes:**

- 1 - Filter element
- 1 - Mounting head
- 1 - Vacuum gauge 0 - 30 hg, 1/8" NPT



 UL file: MH25548  
 UL Style: 41439

**Part Number:** 41436M  
 Oil Filter UL - Quick Spin III - kit #3

**Packaging:** Individually boxed  
**Includes:**

- 1 - Filter element
- 1 - Mounting head
- 1 - Mounting bracket with hardware



 UL file: MH25548  
 UL Style: 41439

**Part Number:** 41403  
 Filter mounting bracket

**Packaging:** Individually bagged & tagged  
**Includes:**

1 - mounting bracket with hardware.  
 Our steel zinc plated bracket will stand up to a variety of hostile environments and vibrations.



**Part Number:** 41437  
 Filter mounting head for QS III  
**Packaging:** Individually bagged & tagged

**Includes:**  
 1 - filter head mount - with plugged gauge port.  
 The "Quick Spin III™" head mount is made of casted aluminum. The head includes two 3/8" NPT, inlet & outlet ports and a 1/8" NPT gauge port, loc-tight sealed and plugged (vacuum gauge not included).



**Part Number:** 41431  
 Filter adaptor kit for QS III  
**Packaging:** Individually bagged & tagged

**Includes:**  
 1 - adaptor kit mounting rod with gaskets.  
 Our adaptor kit allows you to mount our Quick-Spin III™ filter onto General 1A25A & 264 heads for easy modification and adaptation without welding. Use existing heads for maximum filtration with just a couple twists of the wrench. A great way to improve filtration without extra effort.





**Part Number (s):**

- 41402 - Vacuum gauge (0 to -30" Hg. - 1/8" NPT)
- 41402C - Vacuum gauge (0 to -30" Hg. - 1/8" NPT - Color)
- 41406 - Vacuum gauge (0 to -30" Hg. - 1/4" NPT)

**Packaging:** Individually Boxed

**Includes:**

1 - vacuum gauge boxed from the above list.  
 Our vacuum gauges features a easy to read 2" face, is made of high impact acrylic bezel, with a 1/8" or 1/4" NPT bottom mount. Can be used in a variety of applications.



41402



41402C



41406

**Part Number (s):**

- 41404 - Pressure gauge (0 to 30 PSI - 1/8" NPT)
- 41405 - Pressure gauge (0 to 300 PSI - 1/4" NPT)
- 41452 - Pressure gauge (0 to 30 PSI - 1/4" NPT)
- 41456 - Pressure gauge (0 to 200 PSI - 1/8" NPT)
- 41457 - Pressure gauge (0 to 300 PSI - 1/8" NPT)
- 41466 - Pressure gauge (0 to 60 PSI - 1/8" NPT - 1 1/2" FACE)

**Packaging:** Individually Boxed

**Includes:**

1 - pressure gauge boxed from the above list.  
 Our pressure gauges features a easy to read 2" face, is made of high impact acrylic bezel, with a 1/8" or 1/4" NPT bottom mount. Can be used in a variety of applications.



41404



41405



41452



41456



41457



BACK MOUNT  
41466

**Part Number (s):**

- 41460 - Tridicator gauge (2.48" Long Stem X 2 1/2" Dial)
- 41461 - Tridicator gauge (2.75" Long Stem X 4" Dial)
- 41462 - Tridicator gauge (3.62" Long Stem X 2 1/2" Dial)

**Packaging:** Individually Boxed

**Includes:**

1 - tridicator gauge from the above list.  
 Easy to read 2 1/2" face, made of drawn steel with corrosion resistant paint, center back mounting and a high impact polycarbonate window with chrome plated steel ring, with a 1/4"-18 NPT thread. Dual temperature ratings are: 70° F to 320° F / 20° C to 160° C and the pressure range is 0 to 200 PSI. It can be used in a variety of applications.



41460 & 41462



41461

**Part Number:** 41463

Thermometer with spud well

**Packaging:** Individually Boxed

**Includes:**

1 - Thermometer individually boxed.  
 Easy to read 2 1/2" face, is made of drawn steel with corrosion resistant paint, center back mounting and a high impact polycarbonate window with chrome plated steel ring, with a 1/2" NPT removable brass well (2" long from back plate of gauge). Dual temperature ratings are: 32° F to 248° F and 0° C to 120° C. It can be used in a variety of applications.



**Part Number:** 41464

Pressure gauge for Steam

**Packaging:** Individually Boxed

**Includes:**

1 - Thermometer individually boxed.  
 Easy to read 8 1/2" glass face, 1/4" NPT bottom mount in a steel case. 0-30 psi an industry standard. It can be used in a variety of steam applications.



Section 7 - Oil Handling, Gauges, & Smoke Bombs





**Part Number (s):**  
 41473 - Compound Gauge - Color Coded  
 Compound gauge - Color coded  
**Packaging:** Individually Boxed  
**Includes:**  
 1 - compound gauge boxed.  
 Our compound Hg / PSI gauge is color coded for easy viewing and features an easy to read 2" face, is made of high impact acrylic bezel, with a 1/8" NPT, bottom mount. Can be used in a variety of applications. Senses Hg. Vacuum from 0 to 30 Hg and pressure from 0 to 30 PSI. It works great in applications where back pressure is present. Or if your not sure if there is back pressure. Don't take a chance on traditional Hg./Vac gauges. This little investment can save you lots of headache time. Stock up today!



**Part Number:** 43030  
 Tank gauge - Rope type  
**Packaging:** Individually boxed  
**Includes:**  
 1 - Tank gauge  
 Our tank gauge is designed in Germany and can be used in 44" oval tanks with at least one 1 1/2" diameter bushing. The cord is impervious to oil and durable. This gauge features an easy to read 2 1/2" face and extra large easy to read number and letters. an be adapted to use in 2" bushing with adaptor. (not included).



**Part Number:** 43031  
 Tank gauge - Rope type  
**Packaging:** Individually boxed  
**Includes:**  
 1 - Tank gauge  
 Our economy tank gauge is used in 42" & 24" tanks with face plate change & 2" BPS mounting thread. The cord is impervious to oil and durable.



## TUV Tested Flow Control® de-aerator

**Part Number:** 43000 - TUV Tested Flow Control®  
 De-aerator - Flow Control®  
**Packaging:** Individually boxed  
**Includes:**  
 1 - Flow Control® de-aerator & hardware  
 1 - Installation instructions  
 Flow Control® is a unique product that allows for the safest possible transport of oil between the oil tank and the oil burner. Incorporating the advantages of the two pipe system in only one oil line. Prevent break-downs before they occur due to air, dirt, and nozzle clogging. This product works!

**TUV IMPROVED!**

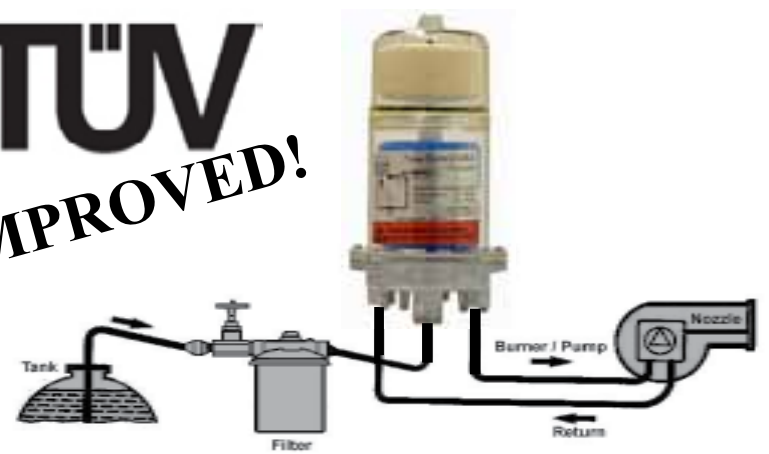

### Look at all the advantages

- ♦ Fewer breakdowns
- ♦ No return line leakage
- ♦ Less soot build-up
- ♦ Simpler and cheaper installations
- ♦ Cleaner exhaust gases
- ♦ Smaller pipe dimensions
- ♦ Lower oil consumption
- ♦ Easier trouble spotting
- ♦ More burners on one suction line
- ♦ Fewer problems with suction leakage and long oil lines
- ♦ Pre-heated oil

### Technical Data:

<b>Max. nozzle capacity:</b> 18.5 GPH	<b>Max. return oil pumped:</b> 37 GPH	<b>Max. oil flow:</b> 50 GPH
<b>Separating capacity:</b> Up to 4 l/h	<b>Max. ambient temp.:</b> 140°F (60°C)	<b>Max. operating temp.:</b> 140°F (60°C)
<b>Operating suction pressure:</b> 7.5 psi max.	<b>Operating over pressure:</b> 10 psi max.	<b>Pressure test of pipe system:</b> 85 psi max.
<b>Pump connections:</b> 1/4" NPT inner thread	<b>Tank connection:</b> 1/4" NPT inner thread	<b>Dimensions:</b> 3.74" X 3.74" X 5.73"





**Part Number:** 43003  
 Fusible Valve - 3/8 (F)NPT X 1/4 (M)NPT

**Packaging:** Poly bagged & tagged

**Includes:**  
 1 - Firomatic® Fusible Valve Designed to automatically close when acted upon by heat of 165° F, manufactured primarily for oil burner installations. This valve has been designed with the fusible element in the handwheel, simply replace the low cost handwheel to reset and restore the valve, eliminating the need to replace the valve. These valves can be operated manually and are provided with self-adjusting stuffing box and back seat features, which prevents leaks at the valve stem.



3/8" (F) NPT

1/4" (m) NPT

**Part Number:**  
 43005 - 24" L x 1/2" Flexible Hose  
 43006 - 36" L x 1/2" Flexible Hose  
 Oil lines - Flexible Steel Braided Hose

**Packaging:** Poly bagged & tagged

**Includes:**  
 1 - Flexible hose from above list with 1 adaptor fittings  
 These hoses have a 1/4" NPT fittings on both ends, for expediting the installation of the Tigerloop® or Flow Control® de-aerator. Made from Perbunan rubber (inside), which is impervious to oil, water and air. This product has a diversity of uses.

**Extra adaptors are available, our P/N: 43009**

**Specifications**

- Pressure rating: 143 psi
- Max. Operating Temp: 165° F
- Max. Flow Rate: 20 GPH
- Suction: 6 Bar



**NOTE:** Fits or replaces Buderus #108902

**Part Number:**  
 43019 - 24" L x 1/2" Flexible Hose  
 43020 - 36" L x 1/2" Flexible Hose  
 Oil lines - Flexible Steel Braided Hose

**Packaging:** Poly bagged & tagged

**Includes:**  
 1 - Flexible hose from above list  
 We are proud to introduce our new 36" long galvanized blue braided hose.

*This hose features:*

- (2) 3/8" female flare swivel ends to accommodate swinging door burner installations and hose replacement.
- No more hose twisting!
- Inside flare ensures a snug fit.
- Swivel ends make installation simple.
- Tested by the manufacturer to meet industry standards.



**Part Number:**  
 43021 - 36" L x 1/2" Bio-fuel flexible hose  
 Oil lines - Flexible Steel Braided Hose

**Packaging:** Poly bagged & tagged

**Includes:**  
 1 - Flexible hose from above list with 1 adaptor fittings  
 These hoses have a 1/4" NPT fittings on both ends, for expediting the installation of the Tigerloop® or Flow Control® de-aerator. This oil- and fuel-resistant flexible elastomer hose is fitted with galvanized steel wire braiding as a pressure or strength bearer. The polymer basis of the inner core is HNBR (hydrogenated butadiene acrylnitrile rubber) which is highly resistant to high temperature. Suitable for use with biodiesel. This product has a B100 Bio-fuel rating. Look for the "Green Colored" braid.

**Extra adaptors are available, our P/N: 43009**

**Specifications**

- Pressure rating: 143 psi
- Max. Operating Temp: 165° F
- Max. Flow Rate: 20 GPH
- Suction: 6 Bar



**NOTE:** Fits or replaces Buderus #108902

**Section 7 - Oil Handling, Gauges, & Smoke Bombs**



**Part Number:**

43022 - 24" L x 1/2" Flexible Hose  
 43023 - 36" L x 1/2" Flexible Hose  
 Oil lines - Flexible Steel Braided Hose

**Packaging:** Poly bagged & tagged

**Includes:**

1 - Riello™ Flexible hose from above list  
 These hoses have a 1/4" (m)NPT removable fittings on one end, swivel fitting and a Riello British male thread on the other end. It's a "one, two punch" equates to easy installation and maintenance of Riello burners. The swivel really speeds up the installation process. Made from Perbunan rubber (inside), which is impervious to oil, water and air.

**NEW - NEW - NEW  
 RIELLO HOSE**

**Specifications**

Pressure rating: 143 psi  
 Max. Operating Temp: 165° F  
 Max. Flow Rate: 20 GPH  
 Suction: 6 Bar



**BRITISH THD'S.**

**Part Number:** 45673

Pump strainers - Model "A & B"

**Packaging:** Individually boxed with gasket

**Includes:**

Strainer and matching gasket as specified above. Made of stainless steel mesh, attached to sturdy nylon ends for long lasting support. Our ribbed design insures maximum filtration. Used in Suntec models A & B pumps. Suntec part #: 3715744 - (1 5/8" tall).



**Part Number:** 45674

Pump strainers - Model "J,H,S,"

**Packaging:** Pkg. of 4 strainers with gaskets

**Includes:**

4 - Strainers and 4 - Strainer gaskets  
 Made of stainless steel mesh, attached to sturdy nylon ends for long lasting support. Our ribbed design insures maximum filtration. Used in Suntec models J and H pumps. Suntec part #: 131622 - (2 1/8" tall).



**Part Number:** 45675

Pump strainers - Model "A"

**Packaging:** Pkg. of 4 strainers with gaskets

**Includes:**

4 - Strainers and 4 - Strainer gaskets  
 Made of stainless steel mesh, attached to sturdy nylon ends for long lasting support. Our ribbed design insures maximum filtration. Used in Suntec model A70 pumps. Suntec part #: 3715101 - (1 1/8" tall).



**Part Number:** 45676

Pump strainers - Model "J,H,S,"

**Packaging:** Individually boxed with gasket

**Includes:**

Strainer and matching gasket as specified above. Made of stainless steel mesh, attached to sturdy nylon ends for long lasting support. Our ribbed design insures maximum filtration. Suntec part #: 131622 - (2 1/8" tall).



**Part Number:** 45677

Pump strainers - Model "B"

**Packaging:** Individually boxed with gasket

**Includes:**

Strainer and matching gasket as specified above. Made of stainless steel mesh, attached to sturdy nylon ends for long lasting support. Our ribbed design insures maximum filtration. Used in Suntec models A pumps. Suntec part #: 3715171 - (1 3/8" tall).



**Part Number:** 45678

Pump strainers - Model "A"

**Packaging:** Individually boxed with gasket

**Includes:**

Strainer and matching gasket as specified above. Made of stainless steel mesh, attached to sturdy nylon ends for long lasting support. Our ribbed design insures maximum filtration. Used in Suntec model A70 pumps. Suntec part #: 3715101 (1 1/8" tall).





**Part Number:** 45678-50  
 Pump strainers - Model "A"  
**Packaging:** 50 Boxes per case  
**Includes:**  
 50 individually boxed strainers with gaskets packed in a master carton.  
 Don't get caught short handed. Buy'em by the case!  
 Made of stainless steel mesh, attached to sturdy nylon ends for long lasting support. Our ribbed design insures maximum filtration. Used in Suntec model A70 pumps. Suntec part #: 3715101 - (1 1/8" tall).



**Part Number:** 45685  
 Pump strainer kit - B2GA  
**Packaging:** Individually boxed with gasket  
**Includes:**  
 Strainer and matching gasket as specified above.  
 Made of stainless steel mesh, attached to sturdy nylon ends for long lasting support. Our ribbed design insures maximum filtration.  
 Used in Suntec model B2GA-8852  
 Replaces Suntec part #: 3715746 (2 1/16" tall).



**NEW!**

**Part Number:** 45681  
 Pump strainer - Riello™  
**Packaging:** Individually boxed w/O-ring gasket  
**Includes:**  
 1 ea. Strainer and 1 ea. matching O-ring gasket.  
 Made of stainless steel mesh, attached to sturdy nylon ends for long lasting support. Gasket is impervious to oil. Used on models F3 to F20 and R35. Riello part #: 3005719



**Part Number:** 45686  
 Pump strainer - Model "K"  
**Packaging:** Individually bagged with gasket  
**Includes:**  
 Strainer and matching gasket as specified above.  
 Made of stainless steel mesh, attached to sturdy nylon ends for long lasting support. Our ribbed design insures maximum filtration. Used in Suntec model "K" pumps (not for gear set with 6 screws)  
 Replaces Suntec part #: 131066.



**NEW!**

**NOTE:** Riello optional pump cover gasket is available  
 Ask for P/N: 60682 sold in 10 - 25 - 100 pks.

**Part Number:** 45683  
 Pump strainer - Danfoss kit  
**Packaging:** Individually boxed with o-ring  
**Includes:**  
 Strainer and o-ring gasket as specified above.  
 Made of stainless steel mesh, attached to sturdy nylon ends for long lasting support. Our ribbed design insures maximum filtration. Used in Danfoss models BFP pumps. 2 bolt cover.  
 Replaces P/N: 071N1392  
 NOTE: Also fits the Beckett Clean Cut Pump.



**NEW!**

**Part Number:** 45687  
 Pump strainer - Levitt R3  
**Packaging:** Individually boxed with gasket  
**Includes:**  
 Strainer and o-ring gasket as specified above.  
 Made of stainless steel mesh, attached to sturdy nylon ends for long lasting support. Our ribbed design insures maximum filtration. Used in Suntec Levitt R-3 pumps.



**NEW!**

**Part Number:** 45684  
 Pump strainer kit - B2TA  
**Packaging:** Individually boxed with gasket  
**Includes:**  
 Strainer and matching gasket as specified above.  
 Made of stainless steel mesh, attached to sturdy nylon ends for long lasting support. Our ribbed design insures maximum filtration. Used in Suntec model B2TA-8851  
 Replaces Suntec part #: 3715742 (1 5/8" tall).



**NEW!**

**Part Number:** 45688  
 Pump strainer - Danfoss CFP  
**Packaging:** Individually boxed with gasket  
**Includes:**  
 Strainer and o-ring gasket as specified above.  
 Made of stainless steel mesh, attached to sturdy nylon ends for long lasting support. Our ribbed design insures maximum filtration.  
 Used in Danfoss models CFP pumps. 4 bolt cover.  
 Replaces P/N: 071H0015



**NEW!**

**Section 7 - Oil Handling, Gauges, & Smoke Bombs**





**Part Number(s):**

60676-10  
 60676-50  
 60676-100  
 Pump strainer gaskets - Model "J,H,S"



**Packaging:** Poly bagged & tagged

**Includes:**

A variety of packaging schemes: 10pk., 50pk or 100pk. of Strainer gaskets in a poly bag.  
 Our gaskets are impervious to oil, and insure a tight seal. Used in Suntec models J and H pumps.

**Suntec part #: 110441**

**Part Number:**

60683-10 (10 pk. of O-rings)  
 60683-50 (50 pk. of O-rings)  
 60683-100 (100 pk. of O-rings)  
 Pump strainer gaskets - Danfoss™ O-Ring



**Packaging:** Poly bagged & tagged

**Includes:**

1 Pack of either 10, 50, or 100 pcs. of above O-ring or gasket. conveniently packaged in re-sealable zip lock bags.  
 Our gaskets are impervious to oil and will ensure a tight seal on all your Danfoss BFP pump tune-ups.

**Replaces #633B0090**

**Part Number(s):**

60678-10  
 60678-50  
 60678-100  
 Pump strainer gaskets - Model "A"



**Packaging:** Poly bagged & tagged .

**Includes:**

A variety of packaging schemes: 10pk., 50pk or 100pk. of Strainer gaskets in a poly bag. Our gaskets are impervious to oil, and insure a tight seal. Used in Suntec model A pumps.

**Suntec part #: 3779801**

**Part Number:**

60684-10 (10 pk. of O-rings)  
 60684-50 (50 pk. of O-rings)  
 60684-100 (100 pk. of O-rings)  
 Pump strainer o-ring - Danfoss™



**Packaging:** Poly bagged & tagged

**Includes:**

1 Pack of either 10, 50, or 100 pcs. of above O-ring or gasket. conveniently packaged in re-sealable zip lock bags.  
 Our gaskets are impervious to oil and will ensure a tight seal on all your Danfoss CFP pump tune-ups.

**Replaces #071H0015**

**Part Number:**

60681-10 (10 pk. of O-rings)  
 60681-50 (50 pk. of O-rings)  
 60681-100 (100 pk. of O-rings)  
 60682-10 (10 pk. of optional cover gaskets)  
 60682-50 (50 pk. of optional cover gaskets)  
 60682-100 (100 pk. of optional cover gaskets)  
 Pump strainer O-Ring & Optional pump cover gasket for Riello™

**Packaging:** Poly bagged & tagged

**Includes:**

1 Pack of either 10, 50, or 100 pcs. of above O-ring or gasket. conveniently packaged in re-sealable zip lock bags.  
 Both gaskets are impervious to oil and will ensure a tight seal on all your Riello tune-ups.

**FOR RIELLO MODELS F3 THRU F20 & R35**

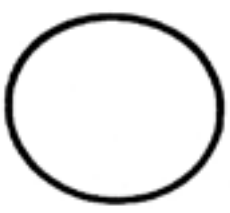

60681



60682

**Part Number:**

60685-10  
 60685-50  
 60685-100  
 Pump strainer gasket - OLD Model "A"

**Packaging:** Poly bagged & tagged

**Includes:**

1 Pack of either 10, 50, or 100 pcs. of above gasket. conveniently packaged in re-sealable zip lock bags.  
 Our gaskets are impervious to oil and will ensure a tight seal on all your Suntec pump tune-ups.

**Replaces #3779051**







**Part Number: 61411**

Filter gasket kit for Fulflo & C4

**Packaging:** Poly bagged & tagged

**Includes:**

1 Package containing one of each of the following:

1 each Head gasket

1 each Bolt gasket

1 each Vent gasket



**Part Number: 61414**

Filter gasket - Vent gasket only for Fulflo & C4

**Packaging:** Poly bagged & tagged

**Includes:**

1 Package containing your specified quantity of:

1 each Vent gasket



**Part Number: 61412**

Filter gasket - Bolt gasket only for Fulflo & C4

**Packaging:** Poly bagged & tagged

**Includes:**

1 Package containing your specified quantity of:

1 each Bolt gasket



**Part Number: 61416**

Filter gasket kit for Fulflo & C4

**Packaging:** Poly bagged & tagged

**Includes:**

1 Package containing your specified quantity of:

1 each Head gasket





**Part Number (s):**

OSVA38 - 3/8" Oil Safety Valve  
 OSVA50 - 1/2" Oil Safety Valve  
 Oil safety valves - Webster® Standard

**Packaging:** Individually boxed

**Includes:**

1 - Webster® oil safety valve from above list  
 The Webster® oil safety valve is ideal for use in oil supply systems which have from zero to 60 psi supply line pressure on the inlet side of the valve, but requires a sustained vacuum on the outlet side of the valve for the fuel to flow to the burner pump. This unit is UL Listed for #2 fuel oil or lighter at 60 psi maximum inlet pressure.



**Look at all the advantages:**

- Relieves pressure strain on fuel pump inlets*
- Prevents siphoning of fuel tanks*
- Prevents spilling due to accidental line breakage*
- Use OSVA38 for 3/8" pipe & ports 3/8 - 18 NPTF
- Use OSVA50 for 1/2" pipe & ports 1/2 - 14 NPTF

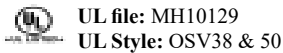

**BIO VERSION**

**Part Number (s):**

OSVA38BIO - 3/8" Oil Safety Valve  
 OSVA50BIO - 1/2" Oil Safety Valve  
 Oil safety valves - Webster® Bio

**Packaging:** Individually boxed

**Includes:**

1 - Webster® oil safety valve from above list  
 The Webster® oil safety valve is ideal for use in oil supply systems which have from zero to 60 psi supply line pressure on the inlet side of the valve, but requires a sustained vacuum on the outlet side of the valve for the fuel to flow to the burner pump. This unit is UL Listed for #2 fuel oil or lighter at 60 psi maximum inlet pressure.



**NEW!**

**Look at all the advantages:**

- Relieves pressure strain on fuel pump inlets*
- Prevents siphoning of fuel tanks*
- Prevents spilling due to accidental line breakage*
- Use OSVA38 for 3/8" pipe & ports 3/8 - 18 NPTF
- Use OSVA50 for 1/2" pipe & ports 1/2 - 14 NPTF

**Part Number (s):**

- 141TF** - 1/2" NPT(m) X 3/8" NPT(m) TANK VALVE
  - B100CV** - NO LONGER AVAILABLE USE B100HCV
  - B100HCV** - 3/8" NPT(f) CHECK VALVE W/SOFT SEAL
  - B100L** - 3/8" NPT(f) LEVER VALVE
  - B104CF** - 3/8" FLARE X 1/4" NPT(m) X 1 5/8" LONG SHANK ANGLE VALVE
  - B104CFXL** - 3/8" FLARE X 1/4"NPT(m) X 2" LONG SHANK ANGLE VALVE
  - B105HCV** - 3/8" FLARE CHECK VALVE W/SOFT SEAL
  - B105F** - 3/8" FLARE VALVE
  - B200F** - 1/2" NPT(f) VALVE
  - B200HCV** - 1/2" NPT(f) CHECK VALVE W/SOFT SEAL
  - B200L** - 1/2" NPT(f) LEVER VALVE
  - B204CF** - 1/2" FLARE X 1/4" NPT(m) X 1 5/8" LONG SHANK ANGLE VALVE
  - B205APF** - 1/2" FLARE ALL PURPOSE / ANTI-HUM VALVE
  - B205F** - 1/2" FLARE VALVE
  - B205HCV** - 1/2" FLARE CHECK VALVE W/SOFT SEAL
  - B300F** - 3/4" NPT(f) VALVE
  - B400F** - 1" NPT(f) VALVE
  - HW165** - 165° F REPLACEMENT HAND WHEEL - "SILVER"
  - HW200** - 200° F REPLACEMENT HAND WHEEL - "COPPER"
  - TS150B** - THERMAL SWITCH UL ROUND JUNCTION BOX
  - TS300B** - THERMAL SWITCH UL SQUARE JUNCTION BOX
- Fusible valves

**Packaging:** Poly bagged & tagged

**Includes:**

1 - Fusible Valve, Tank Valve & Check Valve from above list  
 Designed to automatically close when acted upon by heat of 165°F, unless otherwise specified. These valves has been designed with the fusible element in the handwheel, simply replace the low cost handwheel to reset and restore the valve, eliminating the need to replace the valve. These valves can be operated manually and are provided with self-adjusting stuffing box and back seat features, which prevent leaks at the valve stem. Valve bodies are made of machined brass or cast brass to reduce the erosion caused by fuel oil. The other internal parts are designed for long life and dependability. The best in it's class! All the fusible valves up to 1/2" NPT are UL listed in the US & Canada!



*See Photos on next page*



UL file: MH4681  
 UL Style: Series 50, 100,  
 & 200 Firematic valves.



**UL listed for use in USA and Canada**

**Section 7 - Oil Handling, Gauges, & Smoke Bombs**

**Fusible Inline Burner Valves & Fire Safety Valves**

 <b>141TF</b> 1/2" NPT(m) X 3/8" NPT(m) TANK VALVE - BZ	 <b>B100CV</b> 3/8" NPT(f) CHECK VALVE - BR	 <b>B100F</b> 3/8" NPT(f) VALVE - BR	 <b>B100HCV</b> 3/8" NPT(f) CHECK VALVE - BR
 <b>B100L</b> 3/8" NPT(f) LEVER VALVE - BR	 <b>B104CF</b> 3/8" FLARE X 1/4" NPT(m) X 1 1/4" L ANGLE VALVE - BR	 <b>B104CFXL</b> 3/8" FLARE X 1/4" NPT(m) X 2" L ANGLE VALVE - BR	 <b>B105HCV</b> 3/8" FLARE CHECK VALVE - BR
 <b>B105F</b> 3/8" FLARE VALVE - BR	 <b>B200F</b> 1/2" NPT(f) VALVE - BR	 <b>B200HCV</b> 1/2" NPT(f) CHECK VALVE - BR	 <b>B200L</b> 1/2" NPT(f) LEVER VALVE - BR
 <b>B204CF</b> 1/2" NPT(f) X 1/4" NPT(m) X 1 5/8" L ANGLE VALVE - BR	 <b>B205APF</b> 1/2" FLARE ALL PURPOSE - ANTI-HUM VALVE	 <b>B205F</b> 1/2" FLARE VALVE - BR	 <b>B205HCV</b> 1/2" NPT(f) CHECK VALVE - BR
 <b>B300F</b> 3/4" NPT(F) VALVE - BR	 <b>B400F</b> 1" NPT(F) VALVE - BR	 <b>HW165</b> 165° REPLACEMENT HAND WHEEL - SILVER	 <b>HW200</b> 200° REPLACEMENT HAND WHEEL - COPPER
 <b>TS150B</b> THERMAL SWITCH UL ROUND JB 3 1/4" & 4" ROUND JUNCTION BOX	 <b>TS300B</b> THERMAL SWITCH UL SQUARE JB 4" SQUARE JUNCTION BOX		



**Part Number:** 1002FD  
 Valker® Fast Drying De-greaser

**Packaging:** Corrugated carton - sold in case lots only.  
**Includes:**

12 - 14 oz. aerosol cans per case.  
 This dielectric, non-flammable solvent is fast drying, and ideal for de-greasing small mechanical parts, fans, electric motors, and equipment. Removes grease and oil from hard to reach places. It can even be used as a spot remover.



**Part Number(s):**  
 41900 - 1/2 Minute smoke candle - 12/pk. - 4,000 cu. ft.  
 41901 - 1 Minute smoke candle - 12/pk. - 8,000 cu. ft.  
 41902 - 3 Minute smoke candle - 12/pk. - 40,000 cu. ft.  
 Smoke Candles - Superior

**Packaging:** Poly-bag  
**Includes:**  
 1 - 12/pk. and 5/pk., of each from above list.  
 Our Superior smoke detectors generate smoke by chemical reaction to pinpoint leaks in heating and air conditioning duct work. Smoke varies in color from white to gray depending upon density and lighting.  
 Now featuring new quantity packaging! Now available in packages of 5 for the 1/2 minute, 1 minute and 3 minute sizes.

**Part Number:** 2001CF  
 Valker® Chem Flush - 1

**Packaging:** Corrugated carton - sold in case lots only.  
**Includes:**

12 - 14 oz. aerosol cans per case.  
 Chem-Flush - 1 opens fuel lines that are plugged due to ice and sludge build-up. Chem flush - 1 can also be use to clean the filter pump and nozzle strainer when used as a full maintenance or tune-up product. Therefore, greatly reducing the number of service calls due to plugged fuel lines during the heating season.



-WARNING-  
 STORE IN A COOL / DRY PLACE -  
 DO NOT RE-PACKAGE

**Part Number:** 2007CV  
 Valker® Chem Flush Valve

**Packaging:** Bulk - sold per each.  
**Includes:**

1 - Chem flush valve.  
 The Chem-Flush - 1 valve is required when using Chem-Flush - 1 aerosol P/N: 2001CF. The valve consists of a dispensing cap, flow sight tube, pressure gauge, pressure relief valve with a threaded portion for easy adaption of a standard CO<sup>2</sup> gun.



**Part Number:** 41950  
 Smoke test paper

**Packaging:** Poly bagged & tagged  
**Includes:** 1 package of 50 strips  
 Smoke test paper for Bach & Dwyer testers  
 Packed in a re-sealable zip lock bag with a generous supply of 50 strips per package.



**Part Number:** 2008CT  
 Valker® Sight tube with cap

**Packaging:** Poly bagged & tagged  
**Includes:**

1 - Replacement sight tube  
 This replacement sight tube is used in the Chem-Flush valve.  
 They are sold per each.



**Part Number(s):**  
 S102 - 45 Second smoke emitter 10/pk. - 150 cu. ft.  
 S103 - 90 Second smoke emitter 10/pk. - 600 cu. ft.  
 S104 - 150 Second smoke emitter 5/pk. - 1100 cu. ft.  
 S105 - 240 Second smoke emitter 5/pk. - 2500 cu. ft.  
 Smoke Emitters - Regin

**Packaging:** Various  
**Includes:**  
 1 - Pkg. from the above list  
 Our smoke emitters generate smoke by chemical reaction. Reveals leaks and other faults in heating and air conditioning duct work. Unique plastic cartridge makes for easy handling and disposal.







**Part Number(s):**

- 12-7300 (Large rectangular)
- 12-7400 (Large round)
- 12-7500 (Small rectangular)
- Telescoping inspection mirrors

**Packaging:** Poly bagged & tagged

**Includes:**

1 - Mirror from above selection with extension handle.

Ideal for inspecting burner flame and inside chamber liners. Features three section telescoping action. 29-31" maximum extension. Swivel joint permits viewing from any angle. Mirror is made of highly polished stainless steel for maximum strength.

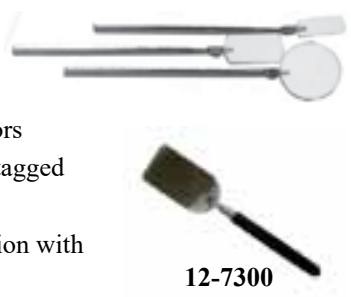

12-7300

**Caution:** Mirror should not be held directly in path of flame. Safety first!

**Part Number:** 12-EL26

Telescoping pocket lighter

**Packaging:** Poly bagged & tagged

**Includes:**

1 - Telescoping lighter tool.

Safety first!. Whether a gas or oil manual ignition test don't get caught without one of these. Light furnaces of all kinds from a safe and comfortable distance. Our lighter extends to 26", for burn free lighting. Our tool also features a pocket clip, and a bright nickel plated finish.



**Part Number:** 12-EM18

Telescoping pocket magnet

**Packaging:** Poly bagged & tagged

**Includes:**

1 - Telescoping magnet tool.

This handy device is a life saver in recovering dropped parts in hard to reach areas, with limited space. A necessity for any tool box. Tool features include a pocket clip, 18" extension reach, and a bright nickel plated finish.



**Part Number(s):**

- 12-T180 (Temp. range -40 to 160 degrees Fahrenheit)
- 12-T220 (Temp. range 0 to 220 degrees Fahrenheit)
- Thermometers - Pocket dial

**Packaging:** Poly bagged & tagged

**Includes:**

1 - Pocket thermometer of choice with casing  
 Used in a variety of applications: Heating, AC, Refrigeration and Laboratory use to mention a few. This tool features a unbreakable lens, 5" stem, protector sleeve with clip. The pocket clip also holds the thermometer in place.



**Part Number:** 12-T302

Thermometers - Digital pocket dial

**Packaging:** Shell packaged for display

**Includes:**

1 - Digital Pocket thermometer & casing  
 Used in a variety of applications: Heating, AC, Refrigeration, food and Laboratory use to mention a few.

This tool features a flat edge non-roll case, stainless steel 5" stem, large display, on/off switch, instant one second update. It has a temperature range of -40 to 302 degrees Fahrenheit and switchable to -40 to 150 degrees Centigrade. The protector sleeve has a pocket clip that also holds the thermometer in place and the battery is included.



**Part Number:** 12-T3N1

Telescoping mirror, magnet & light kit

**Packaging:** Shell packaged for display in case

**Includes:**

- 1 - Telescoping mirror,
- 1 - Telescoping magnet & light tool
- 1 - Sturdy case

This sturdy plastic case keeps your kit safe from damage in your tool box. Each kit contains a telescoping round mirror 2" in diameter that extends to 36" and a telescoping 5 lb. magnet with a built in LED light that extends to 26" to guide the way. This tools also features non-slip, textured PVC coated handles, batteries are included, ready to use off the shelf.



**NEW**

**Section 8 - Tools, Glass, Washers & V-Belts**



**Part Number:** 40400  
Tools - Terminal crimping  
**Packaging:** Poly bagged & tagged  
**Includes:**

1 - Terminal crimping tool in poly bag.  
Our tool is lightweight, and economical.  
This multi-purpose tool is made for durability.  
Handles are plastic coated for comfort.



- Four Tools In One -  
- Bolt cutter - Wire cutter - Crimper - Wire stripper

**Part Number:** 40402  
Tools - Coupling cutter  
**Packaging:** Poly bagged & tagged  
**Includes:**

1 - heavy duty coupling cutter.  
Cuts all sizes up to 1 1/4" in diameter.  
Cuts polyethylene, PVC, ABS, and rubber  
hose materials. Will not distort pipe shape  
when cutting.

For replacement blades for 40402,  
Use **P/N: 40403** (a pack of two).



**NEW**

**Part Number:** 40403  
Tools - Replacement blades for 40402  
**Packaging:** Poly bagged & tagged  
**Includes:**

1 - 2 pack of replacement blades for 40403 tool.  
The blades are sharp. Please exercise caution when  
replacing blades.

**Part Number:** 40406  
Tools - Lineman's pliers  
**Packaging:** Poly bagged & tagged for display  
**Includes:**

1 - heavy duty lineman's crimping tool.  
This 9 1/2" long tool is a multi-tasker in the field.  
It cuts, and crimps our and terminal connector very  
sure and secure. Solid steel construction with foam type  
handles for a sure grip!

**FEATURES**

- \* CROSS SECTIONED JAWS
- \* INDUCTION HARDENED CUTTING EDGES.
- \* HOT RIVETED JOINTS
- \* TEXTURED NON-SLIP GRIP

**NEW**

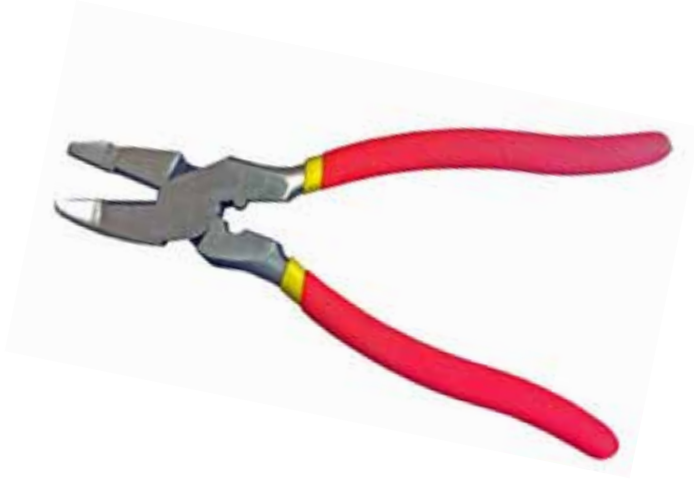



**Part Number:** 40407  
 Tools - Automotive crimper - Manual

**NEW**

**Packaging:** Poly bagged & tagged

**Includes:**

1 - Automotive Terminal crimping tool in poly bag.  
 An automotive favorite and wire harness builder for the HVAC Tech. An essential for the service-person in the field for "on the fly" wire harness modifications. Made of high carbon steel with black oxide finish and plastic hand grips for a sure grip.

- Four Tools In One -
- Bolt cutter - Wire cutter - Variety Crimper - Wire stripper



**Part Number:** 40408  
 Tools - Automotive crimper - Ratcheting

**NEW**

**Packaging:** Poly bagged & tagged

**Includes:**

1 - Automotive Terminal crimping tool in poly bag.  
 An automotive favorite and wire harness builder for the HVAC Tech and wire harness pro. Create "sure" connections in high use areas, An essential for the service-pro in the field for "on the fly" wire harness modifications. The positive ratcheting mechanism adjusts for perfect crimps. Supplied with a variety of crimping jaws that cover a wide variety of wire terminals. Never get caught without the "right" tool. A hardened steel frame design insures longevity and plastic hand grips for a sure grip.



**Part Number:**  
 40417 (for 1 soot kutter)  
 40417-12 (for 12 soot kutters)  
 Tools - Soot kutter

**Packaging:** Poly bagged & tagged for display

**Includes:**

1 - Soot kutter or 1 - 12 pk. of soot kutters  
 Our Soot Kutter is specially designed for easier clearing of soot build-up in most narrow passage boilers. Effectively breaks up hardened carbon deposits. Handle is plastic coated for comfort.

**Soot Kutter!**



**32" Over-all Length**

**Section 8 - Tools, Glass, Washers & V-Belts**



**Part Number:** 40420  
 Tools - Porcelain & gauge glass cutter  
**Packaging:** Poly bagged & tagged  
**Includes:**

1 - Tool with cutting chain.  
 The industry standard and design for cutting insulators and gauge glass in the field. Simple to use, as a pair of pliers. Plastic coated handles for comfort grip.

**Squeeze & Pop!**



**Part Number:** 40425  
 Tools - Squeeze rod style glass cutter  
**Packaging:** Poly-bagged & tagged  
**Includes:**

1 - Gauge glass cutter  
 Works similar to the plier style gauge glass cutter. It offers good leverage on scoring the glass tubing by a means squeezing flexible rods together.



**Part Number:** 40421  
 Tools - Hex key set  
**Packaging:** Plastic holder  
**Includes:**

1 - Holder with 8 hex keys  
 Sizes are:  
 .050, 1/16, 5/64, 3/32, 1/8, 5/32, 3/16, & 7/32  
 The two smallest sizes .050 and 1/16 are 1 3/4" long. All the others are 6" long. The plastic holder ensures you'll never mis-place a hex key ever again, an essential for any tool box.



**Part Number(s):**  
 40428 (Standard blowout gun)  
 40429 (Gun with 150 psi safety valve)  
 Tools - Blowout guns  
**Packaging:** Poly bagged & tagged

**Includes:**  
 1 - Blowout gun and instruction sheet.  
 Our blowout gun uses a CO<sup>2</sup> cartridge (sold separately) and incorporates a 1/4" NPT female connection, that can be adapted to other fittings. It is intended for use in blowing out clogged lines that are vented beyond the restricted point to the atmosphere. It should not be used in a closed end line. Applications include fuel oil lines, machine lubrication systems, instrument transmission lines, and hydraulic pipelines.

The blowout gun with the built in check valve allows the user the ability to remove used CO<sup>2</sup> cartridges without pressure line loss. You can then add additional CO<sup>2</sup> cartridges as needed, up to 150 psi.

**Replacement O-rings are available ask for P/N: 40427-10**

**Part Number:** 40424  
 Tools - Plier style glass cutter  
**Packaging:** Poly-bagged & tagged  
**Includes:**

1 - Gauge glass cutter  
 The plier style gauge glass cutter offers good leverage on scoring the glass tubing by a conventional means that most mechanics are familiar with.



**P/N: 40428**



**P/N: 40429**





**Part Number:** 40430  
 Tools - Electrode tip benders  
**Packaging:** Poly bagged & tagged  
**Includes:**  
 2 - Tip benders.  
 Made of steel with a plated finish. Used for bending and adjusting electrode and igniter tips, this lightweight tool is pocket size and easy to use. One end accommodates 1/8" tips and the other 3/32" tip. A must to take on every service call.



**Part Number:** 40436  
 Tools - Ratchet box wrench  
**Packaging:** Poly bagged & tagged for display  
**Includes:**  
 1 - Ratchet combo box wrench  
 Made of steel with a plated finish. Accommodates a 1/4" hex and a 5/16" hex.



**Part Number(s):**  
 40431 (Control Blast - only)  
 40431K (Control Blast with 3 - 12g cartridges)  
 40432K (Control Blast with 3 - 16g cartridges)  
 Tools - Control Blast blow-out gun  
**Packaging:** Poly bagged & tagged  
**Includes:**  
 1 - Control Blast gun or kits from above list  
 Crown puts you in control with our new trigger activated blow out gun and our new bigger and better 12 or 16 gram CO<sup>2</sup> cartridge. Together they supply the "control" and power "blast" you need to get rid of stubborn oil line clogs.



**Control Blast**

**Part Number:** 40434  
 Tools - Eliminator Tape Measure  
**Packaging:** Shell packaged  
**Includes:**  
 1 - Tape measure 7/8" W tape X 25 Ft. Long  
 A patent hook allows for un-assisted measurements on long pipe lengths. It's "The Pipe Friendly" tape measure with easy to read fractional markings. A must have for the tool box for the plumber in you!

**NEW!**



**Part Number:** 40437  
 Tools - Nozzle Wrench  
**Packaging:** Poly bagged & tagged  
**Includes:**  
 1 - Nozzle Buddy Wrench  
 Our "Nozzle Buddy," tool gets the job done! Install and remove nozzles with ease. Works on all nozzle brands and most adaptors..  
 IMPROVED PIN STRENGTH.



**NOZZLE BUDDY**

Section 8 - Tools, Glass, Washers & V-Belts



Electrode Setting Gauges

Crown carries a full line of specialty setting gauges for Beckett, Carlin, and Wayne burners so that you get a perfect spray pattern every time you set an electrode. Why chance an unnecessary call back?. Set it right the first time with our original line of O.E.M. electrode setting gauges. But that's not all! Use Crown's universal electrode setting gauge if a specialty gauge is not available. It's quick and easy to use for setting all spray patterns!

Crown Part Number	For Model Number	O.E.M. Name
40439	NX & AF II, HLX / AF2	Beckett
40441	AF, AFG, SR, SF & AF II with F & FB retention heads	Beckett Z Gauge
40442	SR Series Burner	Wayne
40443	AF, AFG, SR, & SF	Beckett
40444	Blue Angel HS	Wayne
40445	All Models	Various
40447	99-102	Carlin
40448	Elite	Carlin



**Part Number(s):**

40492-06 (6 pack - 12 gram CO<sup>2</sup> cartridges)  
 40494-06 (6 pack - 16 gram CO<sup>2</sup> cartridges)  
 CO<sup>2</sup> cartridges 12 & 16 gram



**Packaging:** Poly bagged & tagged

**Includes:**

1 - Of the above CO<sup>2</sup> charger combinations above.  
 Intended for use in blowing out clogged oil lines with our blow out gun 40431 Control Blast. this product can be used in a variety of applications ranging from making seltzer water to use in CO<sup>2</sup> bb-guns.

**Part Number:** 49925

Tools - Webster vacuum breaker

**Packaging:** Poly-bagged & tagged

**Includes:**

1 - Vacuum Breaker with instructions.  
 This handy device incorporates a Viton "O" ring seat, a 3/8-18 (f)NPT port. It can also be used as a supply line check valve.



**Part Number:** 695

Tools - Lineman's strip n' crimp pliers

**Packaging:** Poly bagged & tagged

**Includes:**

1 - Lineman's wire stripper and crimper  
 This tool gives you all the benefits of a standard lineman's pliers plus wire stripping and terminal crimping features.  
 A must have for the tool box!

**Strip N'Crimp!**



**Part Number(s):**

40490 (10 - 8gram cartridges per box)  
 40490-12 (12 - 10 pk. boxes per case)  
 40490-36 (36 - 10 pk. boxes per case)  
 CO<sup>2</sup> cartridges - Std. 6 gram



**Packaging:** Boxed

**Includes:**

1 - Of the above CO<sup>2</sup> charger combinations above.  
 Intended for use in blowing out clogged oil lines with our blow out gun 40428 or 40429, this product can be used in a variety of applications ranging from making seltzer water to use in CO<sup>2</sup> bb-guns.



**Part Number:** OSVA TOOL  
 Tools - OSVA Tool

**Packaging:** Poly-bagged & tagged

**Includes:**

1 - OSVA Tool with instructions.  
 This handy tool makes fuel pump priming operations look easy.  
 Inexpensive yet effective.  
 Another reason to stock and install Webster OSV valves.  
 Our P/N's: OSVA50 & OSVA38!



**Part Number:** PTK-10M  
 Pump test manifold tester kit

**Packaging:** Sturdy plastic case

**Includes:**

1 - Test kit  
 Used to test pump pressure and cutoff of fuel oil pumps quickly and accurately.  
 No need to remove pump from oil burner.  
 Can be used on all pumps with operating pressures up to 300 psi.  
 Use with vacuum gauge to analyze problems in oil lines caused by impurities, leaks and high restrictions.



**Part Number:** PTK-2M  
 Pressure & cut off tester kit

**Packaging:** Sturdy plastic case

**Includes:**

1 - Test kit  
 Tests pump pressure and cut-off of fuel oil pumps quickly and accurately without removing the pump from the oil burner.  
 Can be used on all pumps with operating pressures up to 300 psi.

**This Kit Features:**

- Quick hook-up fittings make testing easy, clean and simple.
- Easy-to-follow step-by-step instructions
- Checks operating pressure & cut-off under actual operating conditions.
- Color coded hoses.
- Liquid filled gauge
- All brass body.
- High impact case.

**This Kit Features:**

- Quick hook-up fittings for easy testing.
- Accurately checks pressure, cutoff and vacuum under actual operating conditions.
- Liquid filled gauges for accurate readings.
- High pressure hoses for setting up today's higher pressure pumps.
- High impact case with handle.
- Complete with easy-to-follow instructions.
- Brass and high quality aluminum construction for long life.
- Color coded hoses for pressure hook-up.
- Clear tubing adapts to any suction line.
- Adapter fittings included for all pumps including Riello.

**Part Number:** PTK-T20  
 Riello pump & vacuum tester kit

**Packaging:** Sturdy plastic case

**Includes:**

1 - Test kit

Designed specifically for testing Riello pumps and vacuum.



**This Kit Features:**

- Quick connect European thread fittings.
- Liquid filled gauges to dampen pulsation.
- No hydraulic shock.
- 24" color coded flexible lines.
- High impact plastic case.



**Section 8 - Tools, Glass, Washers & V-Belts**



**Part Number:** PTK-9183

Pump test kit

**Packaging:** Sturdy plastic case

**Includes:**

- 1 - Manifold
- 1 - Vacuum gauge
- 1 - Pressure gauge
- 1 - 1/8" NPT X 1/2" hex adapter
- 1 - 1/4" NPT X 1/2" hex adapter
- 1 - 6" Clear flexible hose w/fittings
- 1 - Instruction sheet



Our pump test kit performs a variety of tests. Benefits include the ability to trouble shoot pump failure, valve failure, and vacuum leaks all in one convenient kit.

**Test Applications**

- Operating Pressure Test
- Cut-Off Test
- Vacuum Test - Lift Application
- Vacuum Test - Fuel Unit

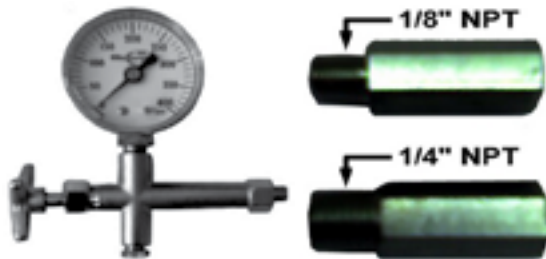

**Part Number:** SW1

Silicone Tape

**Packaging:** Poly-bagged & tagged

**Includes:**

1 - roll 1" W x 12 Yard x .020 thick Silicone tape. This product has thousands of uses. It has 300% elongation stretch capacity. It fuses to itself to form an inseparable bond after 24 hours at room temperature and is water resistant. A great low cost seal in electrical insulation, splicing, and wire wrapping applications. 500° F continuous temperature rating.



**Part Number:** WP-1

Tools - "W" glass cutter

**Packaging:** Poly-bagged & tagged

**Includes:**

- 1 - Gauge glass cutter

This "W" shaped gauge glass cutter offers good leverage in that the mechanic can really lean into the score with their body weight making for deep cuts and easy tap & snap secondary process.



**AQUASTAT IMMERSION WELLS**

Replacement Wells for Honeywell and White Rodgers. Sturdy brass and copper construction for long service life.

Part Number	Description	Honeywell Part Number
PMW-2S	1/2" Standard / 4 7/8" OAL	121371 A
PMW-2SE	1/2" Extended / 6 3/8" OAL	121371 L
PMW-3S	3/4" Standard / 4 7/8" OAL	121371 B
PMW-3SE	3/4" Extended / 6 3/8" OAL	121371 M



PMW-2S

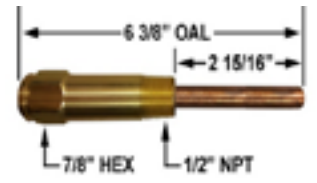

PMW-2SE

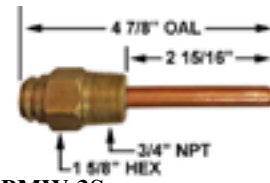

PMW-3S



PMW-3SE





## Gauge Glass Washers - Marvel®

What makes these washers different from others is its patinent molded lip design that ensures a sure seal. Made of standard EPDM rubber that can withstand up to 150 psi and 300° F constant pressure and temperature enviornments with outstanding longevity. The Marvel washers are sold in packages of 12 or individually.



Marvel® Gauge Glass Washers			
Part Number	Size of Glass	OUTSIDE DIMENSIONS	
		DIA.	DEPTH
GGW01-12	1/2"	13/16"	9/32"
GGW02-12	1/2"	7/8"	1/2"
GGW03-12	5/8"	7/8"	9/32"
GGW04-12	5/8"	1"	9/32"
GGW05-12	5/8"	1-1/8"	3/8"
GGW06-12	3/4"	1-1/16"	9/32"
GGW07-12	3/4"	1-1/4"	13/32"
GGW08-12	3/4"	1-5/16"	13/32"
GGW09-12	5/8"	15/16"	9/16"
GGW10-12	3/4"	1-7/16"	13/32"
GGW11-12	3/4"	1-3/16"	13/32"
GGW12-12	9/16"	27/32"	19/32"
GGW13-12	5/8"	15/16"	9/32"
GGW14-12	3/4"	1-1/8"	3/8"
GGW15-12	3/4"	1-1/16"	1/2"
GGW16-12	3/4"	1-5/16"	5/8"
GGW17-12	3/4"	1-1/8"	5/8"
GGW18-12	9/16"	1-3/32"	1/2"
GGW19-12	9/16"	13/16"	9/32"
GGW20-12	11/16"	1"	9/32"
GGW21-12	1/2"	7/8"	3/8"
GGW22-12	3/4"	1-1/4"	1/4"
GGW23-12	3/4"	1-1/4"	3/4"
GGW24-12	3/4"	1-3/32"	13/32"
GGW25-12	5/8"	1"	15/32"
GGW26-12	1"	1-5/8"	1/2"
GGW27-12	7/8"	1-3/8"	13/32"
GGW28-12	1/2"	1"	3/8"
GGW29-12	1/2"	1"	5/16"

Marvel® Gauge Glass Washers			
Part Number	Size of Glass	OUTSIDE DIMENSIONS	
		DIA.	DEPTH
GGW30-12	3/8"	13/16"	1/4"
GGW31-12	3/4"	1"	3/8"
GGW32-12	3/4"	1-3/8"	1/4"
GGW33-12	3/4"	1-1/8"	1/2"
GGW34-12	1/2"	1-7/16"	3/8"
GGW35-12	5/8"	1-15/16"	13/32"
GGW36-12	1-1/4"	1-7/8"	1-15/16"
GGW37-12	5/8"	1-1/4"	1/2"
GGW38-12	1"	1-1/2"	1"
GGW39-12	3/4"	1-1/8"	7/16"
GGW40-12	31/32"	1-3/4"	3/8"
GGW41-12	3/4"	1-3/8"	3/8"
GGW42-12	11/16"	1-3/16"	7/16"
GGW43-12	3/4"	1"	3/4"
GGW44-12	11/16"	1-3/8"	3/8"
GGW45-12	3/4"	1-15/16"	3/8"
GGW46-12	3/4"	1-5/8"	1/2"
GGW47-12	3/4"	1-1/16"	3/4"
GGW48-12	31/32"	1-3/4"	7/16"
GGW49-12	1-7/8"	2-1/4"	3/4"
GGW50-12	21/32"	1-1/4"	1/4"
GGW51-12	11/16"	1-1/8"	3/8"
GGW52-12	5/8"	7/8"	3/8"
GGW53-12	3/4"	1-1/4"	1/2"
GGW54-12	3/4"	1-1/8"	7/8"
GGW55-12	7/8"	1-31/64"	7/8"
GGW56-12	11/16"	1-7/16"	13/32"
GGW57-12	3/4"	15/16"	3/8"

**Section 8 - Tools, Glass, Washers & V-Belts**



## Gauge Glass Washers - Standard

GLASS DIAMETER	PART NUMBER	WASHER SPECIFICATIONS		WALL
		I.D.	O.D.	
5/8"	GGW58	9/16"	11/16"	1/4"
3/4"	GGWS34	3/4"	15/16"	1/4"
1/2"	GGWS12	7/16"	11/16"	5/16"



**\*\*PLEASE SPECIFY -12 OR -100 AT END OF PART NUMBER FOR 12 PER PACKAGE OR 100 PER PACKAGE. FOR 5/8", 3/4", & 1/2" GAUGE GLASS WASHER.**

**NOTE: GGW58 HAS A TEMPERATURE RATING OF 250° F.**

## Friction Rings - Brass

GLASS DIAMETER	PART NUMBER	WASHER SPECIFICATIONS		
		I.D.	O.D.	THICK
5/8"	58BW-12	5/8"	27/32"	1/32"
3/4"	34BW-12	3/4"	15/16"	1/32"



**\*\*58BW-12 IS USED WITH GGW58 GAUGE GLASS WASHERS**

**\*\*34BW-12 IS USED WITH GGW34 GAUGE GLASS WASHERS**

**Part Number(s):**

- 70321 (Conbraco Quality Valve Set)
- 70323 (same as 70321 but has safety check valve)
- 70324 (Contains same as below, but 3/4 NPT & GG 16" L)

**Packaging:** Boxed & GG in corrugated tube

**Includes:**

**MADE IN THE USA**

- 2 - Protection rods
  - 1 - 5/8" OD X 12" Long standard gauge glass
  - 1 - 5/8" ID X 1/2" NPT top valve
  - 1 - 5/8" ID X 1/2" NPT bottom valve with clear out port
  - 1 - Instruction sheet
- Use for all types of liquid level verification; We stock the 1/2" NPT male pipe version, but 3/8" NPT is available upon request.

**Features:**

- Aluminum composition hand wheels
- EPDM gauge glass gaskets standard
- Automatic ball checks help prevent the loss of fluids should the glass be broken.
- Equipped with two copper guard rods
- Standard 1/4" needle drain valve in lower arm
- Rated: 125 psig @ 350°F, 300 psig @ 100°F (See note!)
- CRN Registered OF6616.5C

**Note:** Service ratings are subject to pressure/temperature ratings of gauge glass and glass gaskets.



**'Apollo' Valves**  
Manufactured by Conbraco Industries Inc.

**Part Number:**

- 70322 (5/8 ID kit)
- 70325 (3/4 ID kit)

**NOTE:**  
 Packing nuts can be purchased individually.  
 Use P/N: 58PN



**Packaging:** Boxed

**Includes:**

- 2 - 5/8" ID gauge glass packing nuts (58PN)
- 2 - 5/8" ID gauge glass washers (GGW58-12 or GGW58-100)
- 2 - 5/8" ID gauge glass friction rings (58BW-12)

This kit includes everything you need to repair leaking valves in the field. If individual items are needed specify the P/N's in parenthesis.

**Part Number(s):** 70320

Gauge Glass Valve Kit - Economy

**Packaging:** Boxed

**Includes:**

- 2 - Protection rods 10" L
- 2 - 5/8" ID X 1/2" NPT valve with clear out port
- 1 - Instruction sheet

A cheap economy valve. Features identical valves. Either one can be used as a bottom valve for installation ease.





## Standard Tubular Gauge Glass 5/8" and 3/4" Diameter

<b>Gauge Glass - Standard</b>				
Our 5/8" DIA. soda lime glass is an industry standard. Used in low steam boiler applications. Easy to cut!			<b>MAXIMUM RECOMMENDED WORKING PRESSURE, psi</b>	
<b>OUTER DIAMETER</b>	<b>PART NUMBER</b>	<b>OVER-ALL LENGTH</b>	<b>TEMP UP TO 150° F</b>	<b>STEAM BOILER UP TO 425° F</b>
5/8"	58GG08	8"	205	100 psi
5/8"	58GG10	10"	205	100 psi
5/8"	58GG12	12"	205	100 psi
5/8"	58GG14	14"	190	100 psi
5/8"	58GG16	16"	190	100 psi
5/8"	58GG18	18"	190	100 psi
5/8"	58GG20	20"	185	100 psi
5/8"	58GG24	24"	180	100 psi
5/8"	58GG30	30"	175	**
5/8"	58GG36	36"	165	**
5/8"	58GG48	48"	140	**
5/8"	58GG60	60"	120	**
3/4"	34GG08	08"	205	100 psi
3/4"	34GG10	10"	205	100 psi
3/4"	34GG12	12"	205	100 psi
3/4"	34GG14	14"	200	100 psi
3/4"	34GG16	16"	195	100 psi
3/4"	34GG18	18"	190	100 psi
3/4"	34GG24	24"	180	**
3/4"	34GG36	36"	165	**
3/4"	34GG48	48"	140	**

\*\* MAXIMUM RECOMMENDED LENGTH IN THIS SERVICE IS 24"

5/8" DIA. STANDARD SODA LIME GAUGE GLASS

8" to 12" sold in 12 packs.  
 14" to 36" sold in 6 packs.  
 48" & 60" sold individually.

Our Type I Clear Borosilicate glass has been an industry standard for eons!

Our glass tubing is widely used in low pressure steam boiler applications.

Easily cut to size in the field.  
 - High Chemical Durability  
 - High Hydraulic Resistance

Use Crown's premium Squeeze & Pop cutter #40420.

Sizes are standard, and we will cut to length upon request special lengths. Please call for price & availability.

3/4" DIA. STANDARD GAUGE GLASS

Sold individually.

**Section 8 - Tools, Glass, Washers & V-Belts**



## Gauge Glass - High Pressure

Our popular Schott brand Borosilicate gauge glass is very durable.

MAXIMUM RECOMMENDED WORKING PRESSURE, psi

OUTER DIAMETER	PART NUMBER	OVER-ALL LENGTH	TEMP UP TO	STEAM BOILER
			150° F	UP TO 425° F
1/2"	12HP08	8"	460	340 psi
1/2"	12HP10	10"	445	335 psi
1/2"	12HP12	12"	435	325 psi
1/2"	12HP14	14"	415	315 psi
1/2"	12HP16	16"	400	300 psi
1/2"	12HP18	18"	385	295 psi
1/2"	12HP20	20"	375	285 psi
1/2"	12HP24	24"	340	270 psi
1/2"	12HP30	30"	295	**
1/2"	12HP36	36"	260	**
1/2"	12HP48	48"	205	**
1/2"	12HP60	60"	155	**
3/4"	34HP08	8"	425	315 psi
3/4"	34HP10	10"	410	310 psi
3/4"	34HP12	12"	400	300 psi
3/4"	34HP14	14"	385	290 psi
3/4"	34HP16	16"	370	280 psi
3/4"	34HP18	18"	355	275 psi
3/4"	34HP20	20"	345	265 psi
3/4"	34HP24	24"	315	250 psi
3/4"	34HP30	30"	275	**
3/4"	34HP36	36"	240	**
3/4"	34HP48	48"	190	**
3/4"	34HP60	60"	145	**
5/8"	58HP08	8"	435	320 psi
5/8"	58HP10	10"	420	315 psi
5/8"	58HP12	12"	410	305 psi
5/8"	58HP14	14"	390	295 psi
5/8"	58HP16	16"	375	285 psi
5/8"	58HP18	18"	360	280 psi
5/8"	58HP24	24"	320	255 psi
5/8"	58HP36	36"	245	**
5/8"	58HP48	48"	165	**
5/8"	58HP60	60"	150	**



**5/8" DIA. HIGH PRESSURE DURAN® BOROSILICATE GLASS 3.3**

Sold individually.

These are made from Schott's heat resistant Borosilicate® brand tubing. It is highly resistant to water, neutral, acid solutions, concentrated acids, acid mixtures, as well as chlorine, bromine, iodine and organic substances.

They are the most versatile and popular type used in our industry.

**Application:** Sight & flow indicators.

**Benefits:** Visual indication of liquid flow, contamination or discoloration of liquid, metering a constant rate of flow through a fixed port .

**End Finish:** Saw cut and fire-polished

**NOTE:** Harsh environments should be monitored daily. As temperatures rise so will corrosion levels. If clouding is observed replace tubing.

\*\* MAXIMUM RECOMMENDED LENGTH IN THIS SERVICE IS 24"





## Gauge Glass - Red Line

It's very easy to spot liquid levels from a distance when you use our DURAN® brand redline tubular gauge glass.

**MAXIMUM RECOMMENDED WORKING PRESSURE, psi**

OUTER DIAMETER	PART NUMBER	OVER-ALL LENGTH	MAXIMUM RECOMMENDED WORKING PRESSURE, psi	
			TEMP UP TO 150° F	STEAM BOILER UP TO 425° F
1/2"	12RL10	10"	370	295 psi
1/2"	12RL12	12"	360	295 psi
1/2"	12RL14	14"	345	290 psi
1/2"	12RL16	16"	335	285 psi
1/2"	12RL24	24"	280	270 psi
1/2"	12RL36	36"	215	**
1/2"	12RL48	48"	175	**
3/4"	34RL12	12"	330	275 psi
3/4"	34RL14	14"	320	270 psi
3/4"	34RL16	16"	310	265 psi
3/4"	34RL18	18"	300	260 psi
3/4"	34RL20	20"	285	260 psi
3/4"	34RL24	24"	260	250 psi
3/4"	34RL36	36"	200	**
3/4"	34RL48	48"	160	**
5/8"	58RL08	8"	370	285 psi
5/8"	58RL08 1/2	8 1/2"	370	285 psi
5/8"	58RL09 1/2	9 1/2"	370	285 psi
5/8"	58RL09 1/4	9 1/4"	370	285 psi
5/8"	58RL09 3/4	9 3/4"	370	285 psi
5/8"	58RL09 5/8	9 5/8"	370	285 psi
5/8"	58RL10	10"	345	280 psi
5/8"	58RL10 1/2	10 1/2"	345	280 psi
5/8"	58RL10 1/4	10 1/4"	345	280 psi
5/8"	58RL10 3/4	10 3/4"	345	280 psi
5/8"	58RL11 1/2	11 1/2"	345	280 psi
5/8"	58RL11 1/4	11 1/4"	345	280 psi
5/8"	58RL11 3/4	11 3/4"	345	280 psi
5/8"	58RL12	12"	335	280 psi
5/8"	58RL14	14"	325	275 psi
5/8"	58RL16	16"	315	270 psi
5/8"	58RL18	18"	305	265 psi
5/8"	58RL24	24"	265	255 psi
5/8"	58RL28	28"	235	**
5/8"	58RL36	36"	205	**
5/8"	58RL48	48"	165	**
5/8"	58RL60	60"	**	**
5/8"	58RL72	72"	**	**

\*\* MAXIMUM RECOMMENDED LENGTH IN THIS SERVICE IS 24"



### DURAN® BRAND REDLINE GAUGE GLASS

It's very easy to spot liquid levels from a distance when you use our DURAN® brand redline tubular gauge glass. The red stripe on a white background gives a special optical effect which makes the liquid level stand out clearly. This feature allows for easy viewing of liquid levels from across the room.

#### 1/2" Diameter

Sold individually.

#### 5/8" Diameter

Sold per dozen (12 per case)  
24" to 72" sold individually.

#### Stocked Odd Sizes

We stock the following odd sizes in 5/8" Dia. lengths: 8 1/2", 9 1/4", 9 1/2", 9 3/4", 10 1/4", 10 1/2", 10 3/4", 11 1/4", 11 1/2", & 11 3/4"

Other lengths are available.

Minimum quantities required on all special orders.

#### 3/4" Diameter

Sold individually.

**Section 8 - Tools, Glass, Washers & V-Belts**



## Heavy Wall Red Line Gauge Glass

It's very easy to spot liquid levels from a distance when you use our DURAN® brand redline tubular gauge glass.			MAXIMUM RECOMMENDED WORKING PRESSURE, psi	
OUTER DIAMETER	PART NUMBER	OVER-ALL LENGTH	TEMP UP TO 150° F	STEAM BOILER UP TO 425° F
3/4"	34RLHW12	12"	600	340 psi
3/4"	34RLHW14	14"	600	335 psi
3/4"	34RLHW16	16"	600	325 psi
3/4"	34RLHW18	18"	600	320 psi
3/4"	34RLHW20	20"	600	315 psi
3/4"	34RLHW24	24"	580	300 psi
3/4"	34RLHW36	36"	500	**
3/4"	34RLHW48	48"	340	**
5/8"	58RLHW10	10"	600	345 psi
5/8"	58RLHW12	12"	600	340 psi
5/8"	58RLHW14	14"	600	335 psi
5/8"	58RLHW16	16"	600	325 psi
5/8"	58RLHW18	18"	600	320 psi
5/8"	58RLHW24	24"	580	300 psi
5/8"	58RLHW36	36"	500	**
5/8"	58RLHW48	48"	340	**

**\*\* MAXIMUM RECOMMENDED LENGTH IN THIS SERVICE IS 24"**



**DURAN® BRAND**  
**HEAVY WALL**  
**REDLINE GAUGE GLASS**

It's very easy to spot liquid levels from a distance when you use our DURAN® brand redline tubular gauge glass. The red stripe on a white background gives a special optical effect which makes the liquid level stand out clearly. This feature allows for easy viewing of liquid levels from across the room. Use our heavy wall for those high temp and pressure application.

**3/4 & 5/8" Diameter**

Sold individually.  
Additional packaging charges may apply on longer lengths.

### Gauge Glass Protector Rods

Our gauge glass protector rods are made from .1875 diameter Stainless Steel and crimped on one end to catch the eyelets of the valves they are used on.  
Custom sizes are no problem and ships in two days!

### Gauge Glass Protector Rods

Part Number	Description	For Use On
GGR14	14" GG PROTECTOR RODS - 2/PK	12" LONG GAUGE GLASS
GGR18	18" GG PROTECTOR RODS - 2/PK	16" LONG GAUGE GLASS
GGR26	26" GG PROTECTOR RODS - 2/PK	24" LONG GAUGE GLASS
GGR36	36" GG PROTECTOR RODS - 2/PK	34" LONG GAUGE GLASS
GGR38	38" GG PROTECTOR RODS - 2/PK	36" LONG GAUGE GLASS
GGR40	40" GG PROTECTOR RODS - 2/PK	40" LONG GAUGE GLASS
GGR50	50" GG PROTECTOR RODS - 2/PK	48" LONG GAUGE GLASS
GGR62	62" GG PROTECTOR RODS - 2/PK	60" LONG GAUGE GLASS
GGR74	74" GG PROTECTOR RODS - 2/PK	72" LONG GAUGE GLASS





## V- Belts - Fractional



**Don't gamble on another brand...  
 We have the winning hand!**



Our Industrial V-Belts are designed for a wide variety of applications including heating and AC. All of our belts meet or exceed RMA standards and under-go ISO-9001 test standards. Our belts are constructed from tough, long-lasting synthetic rubber, reinforced with low elongation polyester cords. Specially designed synthetic rubber compounds give heat and oil resistance, which ensures that the belt will perform day after day in a wide range of ambient temperatures.

We typically stock a wide range of dual A / 4L series belts. All other series are considered non-stock and usually ship between 3 - 7 working days upon receipt of order.

### Our Replacement Warranty

Our belts are warranted to be free from defects in materials and workmanship. This warranty is limited to replacing any belt, which is proven to be defective within 180 days from date of purchase under the following provisions:

- The belt was used in its designed application.
- The product is delivered to Crown with transportation charges prepaid (Call for RGA #)
- Analysis verifies that the product was properly handled, mounted, lubricated & not subject to abuse.

### How To Order

- 1) Select desired belt: Fractional or Hi-Power.
- 2) Select top width and thickness desired.  
Note: All of these belts are pitched at a 40 degree angle.
- 3) Select desired INSIDE length for A & B series or if ordering 3L, 4L or 5L, then select desired OUTSIDE length.
- 4) To order an A or B series belt that has an INSIDE length of 35", the part number would be A35 or B35.
- 5) To order a 3L, 4L, or 5L belt that has an OUTSIDE length of 35", the part number would be 3L350, 4L350 or 5L350.



### Fractional Horsepower V-Belt Dimensions



### Classical V-Belt Dimensions

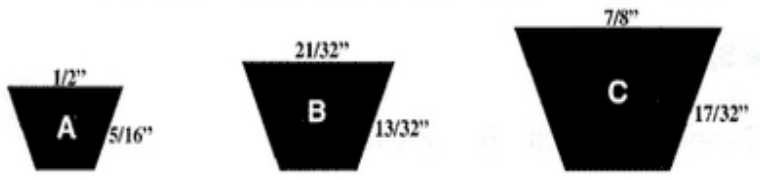

**Section 8 - Tools, Glass, Washers & V-Belts**



## Serviceman's Trouble-shooting Chart

Reproduced by special permission of ICM magazine

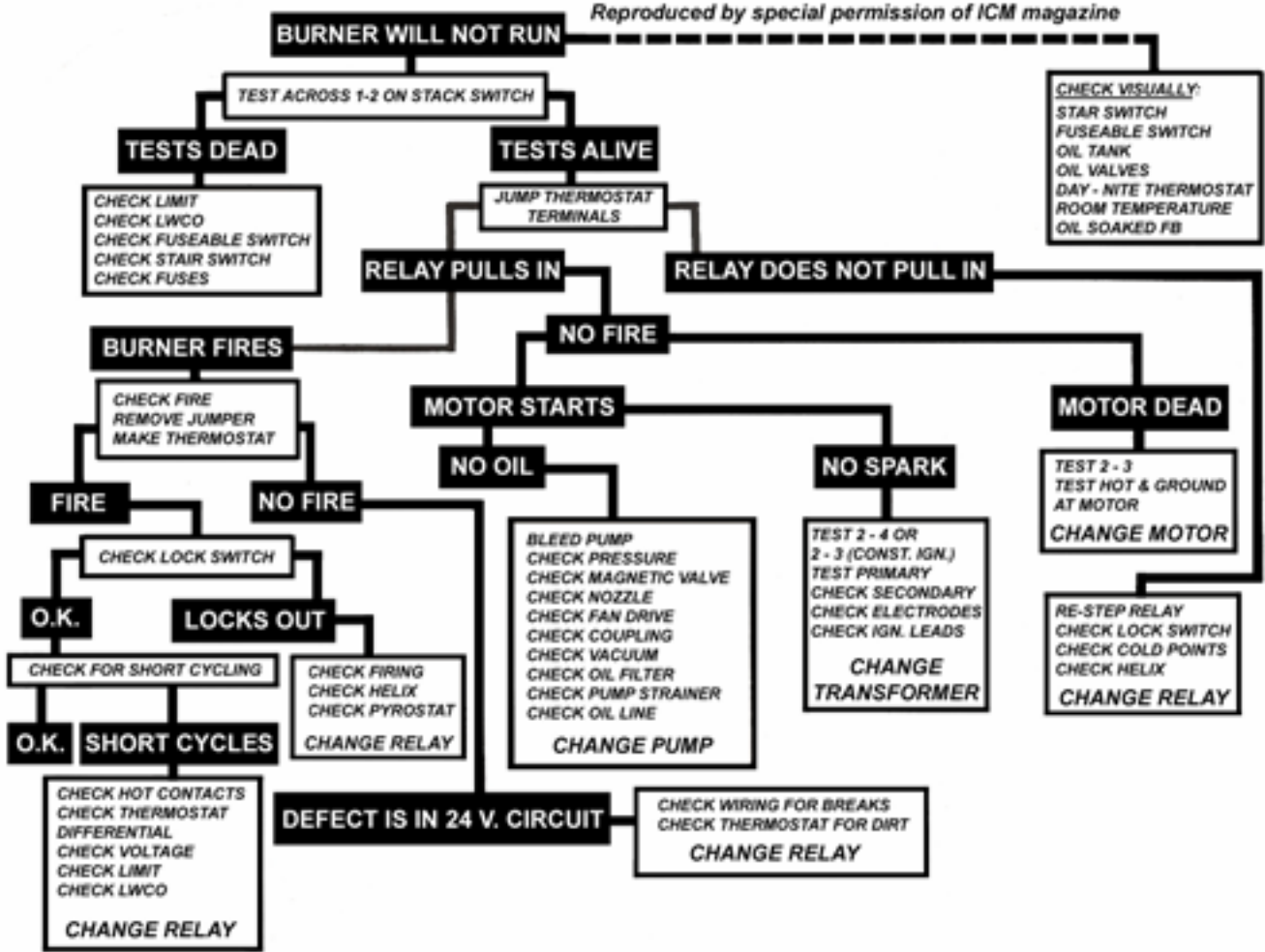

**RECOMMENDED ELECTRODE SETTINGS FOR MOST HIGH PRESSURE GUN-TYPE OIL BURNERS**  
 (Unless otherwise specified by burner manufacturer)

Recommended spacing over surface of an insulator between any part of the electrode and nearest grounded metal part, as indicated below.

Secondary Voltage of Ignition Transformer	Minimum Surface Distance Over Insulator
Not more than 6,000	1"
Not more than 10,000	1½"
Not more than 15,000	2"

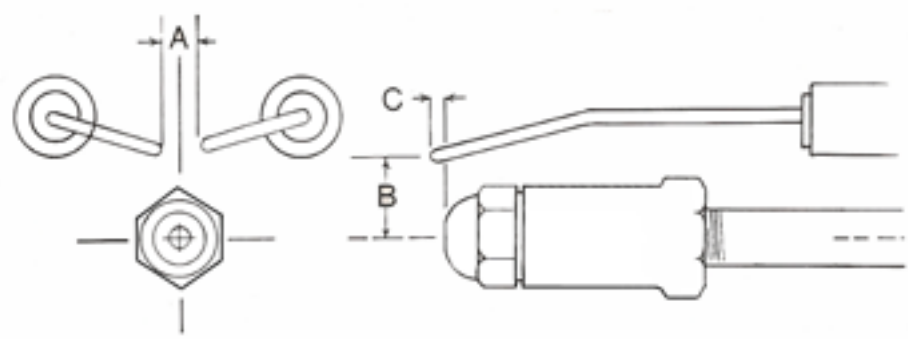

Nozzle GPH	A	B	C
45° (.75 to 4.00)	1/8" to 3/16"	1/2"	1/4"
60° (.75 to 4.00)	1/8" to 3/16"	5/8"	1/4"
70° (.75 to 4.00)	1/8" to 3/16"	5/8"	1/8"
80° (.75 to 4.00)	1/8" to 3/16"	5/8"	1/8"
90° (.75 to 4.00)	1/8" to 3/16"	5/8"	0

Above 4.00 gph it may be advisable to increase dimension "C" by 1/8" to insure smooth starting





Wayne's line of high performance stainless steel and cast iron air cones makes for higher efficiency, lower emissions, lower nozzle temperatures and improved flame control to prevent smoke and soot build-up, which is an important feature, since soot can block efficient heat transfer and reduce efficiency.

## Air Cones for Wayne Burners

<b>Part Number</b>	<b>Burner Model Number</b>	<b>Firing Rate G.P.H.</b>	<b>Material Type</b>
12329	M & E	2.25 - 3.00	Cast Iron
12442	OE & M	.75 - 1.50	Cast Iron
12988	MH & EH Flamelock	.50 - 6.00	Stainless Steel
12988-002	Flamelock Nozzle w/adaptor	.50 - 6.00	Stainless Steel & Brass
12989	EH & MH	1.75 - 2.00	Cast Iron
12990	MH & EH	4.00 - 4.50	Cast Iron
13002	MH & EHA	1.00 - 1.50	Cast Iron
13003	MH, EH, & EHA	5.00 - 6.00	Cast Iron
13127	FH & FHA	7.00 - 11.00	Cast Iron
13128	FH	11.00 - 13.00	Cast Iron
13470	MOC80 & MOC100	.60 - .75	Cast Iron
13702	EH & EHA	3.00 - 5.00	Cast Iron
14157	#1ASR for MSR & EHASR	.75 - 1.00	Stainless Steel
14158	#2ASR for MSR & EHASR	1.00 - 1.50	Stainless Steel
14159	#3ASR for MSR & EHASR	1.60 - 2.00	Stainless Steel
14160	#4ASR for MSR & EHASR	2.00 - 2.25	Stainless Steel
14203	FH & FHA	4.00 - 7.00	Cast Iron
14302	#5ASR for MSR	.50 - 1.25	Stainless Steel
14365	#6ASR for MSR & EHASR	.75 - 2.00	Stainless Steel
14396	#8ASR for MSR & EHASR	1.75 - 3.00	Stainless Steel
100060	#SC for MSHR & MSR	.50 - .75	Stainless Steel
100328	#SD for HSRH-1	.75	Stainless Steel
100333	#SE for HSRH-1	.60	Stainless Steel
100389	HS	1.00 - 2.25	Cast Iron
100420	HS	.50 - 2.50	Cast Iron
100333-002	#SE2 for EG1 & MEG1	.60	Stainless Steel
100393-SER	HS for Flamelock 10 vane	3.00	Stainless Steel
100485-001	HS for Flamelock	.50 - .85	Stainless Steel
100531-001	HS	2.50 - 3.00	Cast Iron
14157-001	#1SR for HSR & EG1	.75 - 1.00	Stainless Steel
14160-004	#4SR for HSR & EG1	2.50 - 3.00	Stainless Steel
62393-001	HSG200	60-200 MBTU	Cast Iron

**SEE PHOTOS ON NEXT PAGE**

**Section 9 - Other Burner Parts**













 Back View P/N: 12329	 P/N: 12442	 P/N: 12988	 P/N: 12989	 P/N: 12990	 P/N: 13002
 P/N: 13003	 P/N: 13127	 P/N: 13128	 Back View P/N: 13470	 P/N: 13702	 P/N: 14157
 P/N: 14158	 P/N: 14159	 P/N: 14160	 Back view P/N: 14203	 P/N: 14365	 P/N: 14396
 P/N: 100060	 P/N: 100328	 P/N: 100333	 Side View P/N: 100389	 P/N: 100420	 P/N: 100333-002
 P/N: 100393-SER	 P/N: 100485-SER	 Back View P/N: 100531-001	 P/N: 14157-001	 P/N: 14160-004	 Side View P/N: 62393-001
 P/N: 12988-002					



**Air Cones for Beckett Burners**

Part Number	Burner Model Number	Firing Rate G.P.H.	Material Type
F0	AF & SR	.40 - .75	Stainless Steel
F0H	AF & SR with Heat Shield	.40 - .75	Stainless Steel
F12	AF, SR, & SF	1.10 - 2.25	Stainless Steel
F16	Special Application	Various	Stainless Steel
F22	AF, SR, & SF	1.25 - 3.25	Stainless Steel
F220	SF	1.75 - 3.25	Stainless Steel
F3	AF & SR	.75 - 1.25	Stainless Steel
F31	AF	2.50 - 3.00	Stainless Steel
F310	SF	2.50 - 5.50	Stainless Steel
F310	SF	2.50 - 5.50	Stainless Steel
F3H	AF & SR with Heat Shield	.75 - 1.25	Stainless Steel
F4	AF & AFG	1.75 - 1.35	Stainless Steel
F6	AF & SR	.85 - 1.65	Stainless Steel
FB0	AF II 85 & 150	.40 - 1.00	Stainless Steel
FB3	AF II 85 & 150	.55 - 1.20	Stainless Steel
FB4	AF II 150	1.10 - 1.25	Stainless Steel
FB5	AF II 150	1.15 - 1.35	Stainless Steel

 F0 0.40-0.75 gph P/N: F0	 P/N: F0H	 F12 1.10-2.00 gph P/N: F12	NO PHOTO P/N: F16	 F22 1.65-2.50 gph P/N: F22	NO PHOTO P/N: F220
 F3 0.75-1.25 gph P/N: F3	 F31 2.50-3.00 gph P/N: F31	NO PHOTO P/N: F310	NO PHOTO P/N: F3H	NO PHOTO P/N: F4	 F6 0.85-1.65 gph P/N: F6
 P/N: FB0	 P/N: FB3	 P/N: FB4	 P/N: FB5	NO PHOTO	NO PHOTO

**Section 9 - Other Burner Parts**

U.S. Postage  
**PAID**  
Farmingdale, NJ  
Permit No. 72



**PO BOX 846 - FARMINGDALE, NJ 07727**

**TEL: 800-631-2153 FAX: 888-645-7278**

**[www.crownengineering.com](http://www.crownengineering.com)**