



# CROWN

PRODUCTS COMPANY, INC.

Residential and Commercial Air Duct Products  
Catalog No. 29  
January 2023



Serving the HVAC Industry Since 1964

[www.crownproductsco.com](http://www.crownproductsco.com)

# Residential and Commercial Air Duct Products

## INDEX

### Residential Products

<b>Page</b>	<b>Contents</b>
1	Snaplock Pipe, Rigid Vent Pipe 10ft. Joints, Aluminum Flexible Pipe
2	Adjustable Elbows and Angles, Tees, Reducers, Wyes
3	Takeoffs for Round and Rectangular Steel Duct, Register Boots and Boxes
4	Insulated Register Boots and Boxes, R-4.2 and R-6.0
5	Insulated Register Boxes, R-6.0 & R-8.0 and Boxes with Gasket
6	Ceiling Radiation Damper Boxes
7	Starting Collars; No. 261 Series, No. 720 Series, No. 650 Series
8	Starting Collars; No. 616 Series, Round Damper Sleeves, Flex Duct Connector, Backup Ring, and No. 620 Series
9	Starting Collars; No. 710 Series and No. 711 Series
10	Starting Collars; No. 310 Series and No. 311 Series
11	The Dryerbox and Exhaust Vents
12	Stands for Air Handler Units, Condensing Unit Tie Down Brackets
13	Radius Plenums, Drain Pans, Unit Adapters, Duct Board Boxes, Plenum Box Legs
14	Filter Housings, Can Stock, End Cap, Manual Volume Damper, Condensing Unit Cover, Line Covers and Expand-O-Duct
15	Plenums, Square to Round Transitions, Round Flex Connectors
16	Passive Return Sleeves, Duct Hangers, Mounting Brackets
17	Vent Tops, Flashings, Wallstack and Fittings
18	Mobile Home Duct Work Fittings and Duct Kits

### Commercial Products

19	Commercial Duct Full Service Provider Information
20	Rectangular Duct and Fittings: S-Lock & Drive Type and Bolt Together Type B
21	Turning Vane & Vane Rail, Transverse Duct Connections, Slot Diffuser Plenums
22	Single Wall Spiral Duct Work
23	Single Wall Spiral Duct Work with The Edge Gasket System
24	Single Wall Flat Oval Spiral Duct Work
25	Double Wall Spiral Duct Work
26	Access Doors
27	Commercial Damper Sleeves and Ceiling Diffuser Adapters
28-31	Commercial Takeoff Fittings
32-33	Numerical Index

#### RETURN POLICY

All returned material must be approved by Crown Products Company, Inc., prior to returning. A **"Product Return Request Form"** must be completed and returned with the material. Non-stock items may not be returned. A 15% restocking fee will be applied to all accepted returns.

#### WARRANTY

Crown Products Company, Inc. warrants that the air ducts and fittings it manufactures are produced in accordance with the standards and specifications shown in this catalog. No warranty of suitability for any particular purpose, nor any other presentation or warranty, whether expressed or implied, is made respecting these products.

# SNAPLOCK PIPE

Galvanized Steel

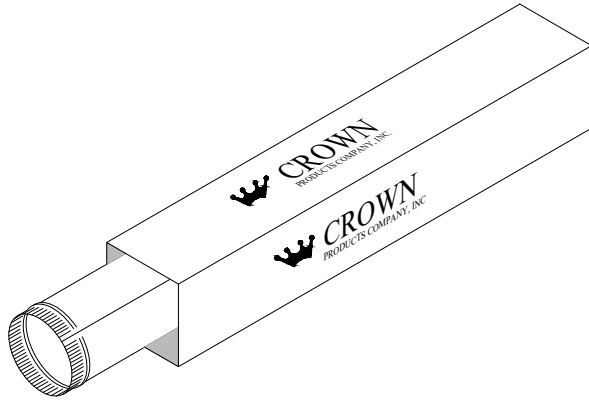

**101 SNAPLOCK PIPE**

**Sizes: 3" through 24" diameter**

DIAMETER	LENGTH	PACKAGING
3" - 14"	2 Ft.	20' per bundle
3" - 9"	5 Ft.	50' per carton
10" - 14"	5 Ft.	30' per bundle
12" - 20"	3 Ft.	30' per bundle
22" - 24"	3 & 4 Ft.	No Standard Packaging

**Gauges:**

Pipe is available in U.S. Gauges  
 30 ga. thru 24 ga. in Reeves Snaplock  
 22 ga. in ACME Lock (Hammerlock)

# RIGID VENT PIPE

Galvanized Steel

**100 RIGID VENT PIPE**

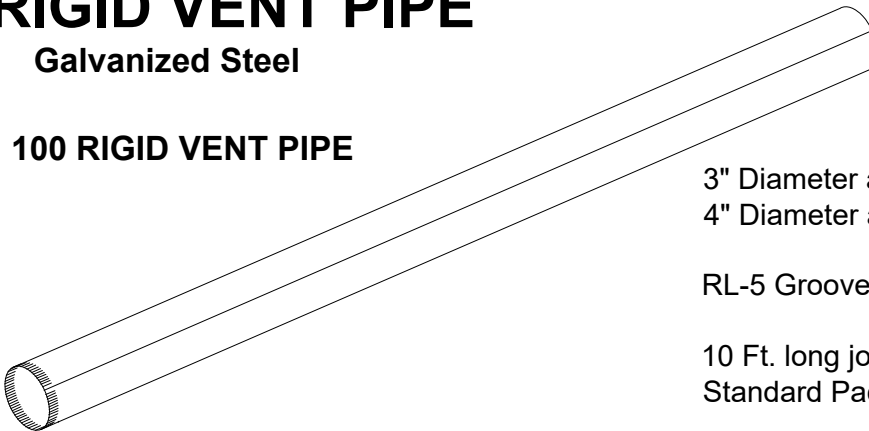

3" Diameter available in 28 & 26 Gauge  
 4" Diameter available in 28 & 26 Gauge

RL-5 Grooved Seam Pipe Lock

10 Ft. long joints  
 Standard Packaging: 1,000 Ft. per pallet

# ALUMINUM FLEXIBLE PIPE

**105 FLEX PIPE**

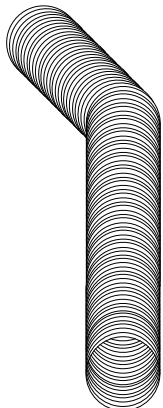

Not recommended for range hood duct.  
 Ideal for bathroom and other air duct requirements.  
 Furnished in 8-Ft. sections.

<b>Duct Nominal Diameter (I.D.)</b>	<b>3" through 12"</b>
Recommended Bend Radius	1.5 x Diameter to Center Line of Duct
Temperature Range	-60°F to +600°F
Maximum Operating Pressure	10" w.c. positive & 12" w.c. negative; 5,500 FPM
Listed U.L. 181	Class 0 Air Duct, meets requirements - NFPA Bulletin 90-A

**107 FLEX PIPE**

8-Ft. section - compressed to 38" long.  
 Compressed aluminum pipe is not covered by the U.L. 181 test procedure.

# ADJUSTABLE ELBOWS 90°

Galvanized Steel

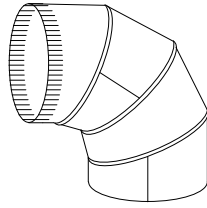

111 ADJUSTABLE ELBOW

Sizes: 3" - 24" diameter  
(Elbows 22" - 24" diameter are 5-piece elbows.)

**DIAMETER**

- 3" - 8"
- 9" - 10"
- 12" - 16"
- 18"
- 20" - 24"

**PACKAGING**

- 12 per carton
- 8 per carton
- 4 per carton
- 2 per carton
- 4 per bundle, strapped

# ADJUSTABLE ANGLE 45°

Galvanized Steel

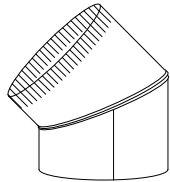

121 ADJUSTABLE ANGLE

Sizes: 4" - 24" diameter  
Gauges: 30 ga. - 22 ga.

# TEES

Galvanized Steel

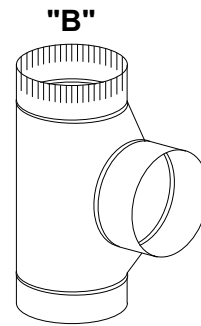

"A"

271

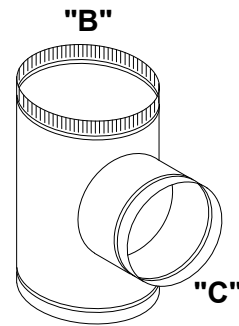

"A"

271-T  
(TAP-IN DESIGN)

**COLLAR SIZE**

- 3" - 8"
- 9" - 12"
- 14" - 18"
- 20" - 24"

**GAUGE**

- 30
- 28
- 26
- 24

FOR REDUCING TEES  
ORDER AS "A" x "B" x "C"

# REDUCER-INCREASER

Galvanized Steel

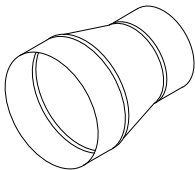

265 TAPERED REDUCER

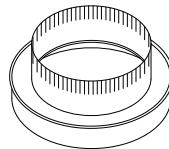

266 FLAT REDUCER

# WYES

Galvanized Steel

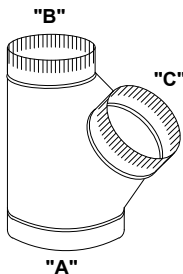

276 IN LINE WYE

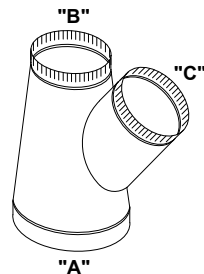

276-T TAP-IN WYE

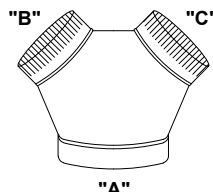

277 BULL NOSE

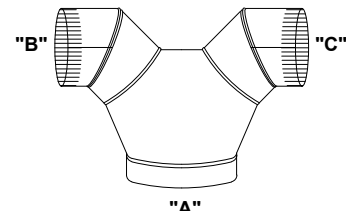

279 2-WAY  
ADJUSTABLE WYE

**COLLAR "A" SIZE**

- 4" - 8"
- 9" - 14"
- 16" - 22"
- 24"

**GAUGE**

- 30
- 28
- 26
- 24

ORDER AS "A" x "B" x "C"

278 1-WAY  
ADJUSTABLE WYE  
(NOT SHOWN)

# TAKEOFFS

Galvanized Steel

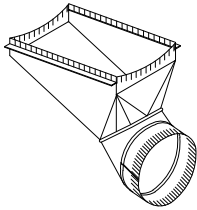

**305 ROUND TAKEOFF**

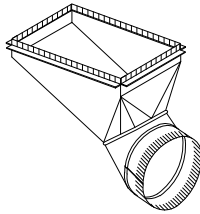

**306 ADJUSTABLE TAKEOFF**

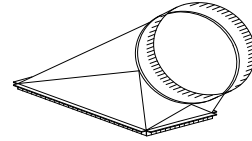

**309 SIDE TAKEOFF**

# REGISTER BOOTS & BOXES

Galvanized Steel

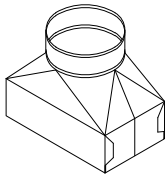

**241 STRAIGHT BOOT**

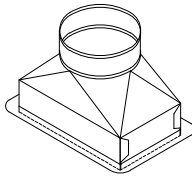

**242 FRAMED BOOT**

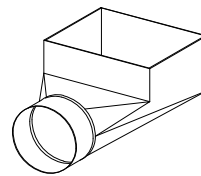

**243 90° ANGLE BOOT**

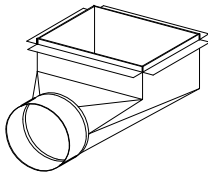

**243-F 90° ANGLE BOOT  
with DRYWALL FLANGE**

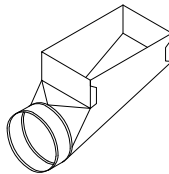

**244 CENTER END BOOT**

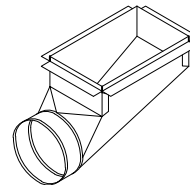

**244-F CENTER END BOOT  
with DRYWALL FLANGE**

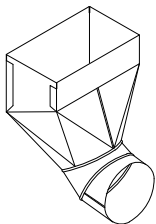

**246 ADJUSTABLE BOOT**

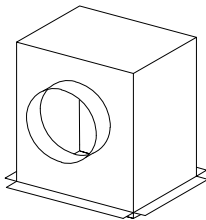

**269 REGISTER BOX**

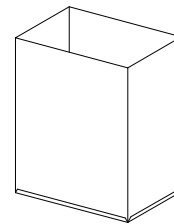

**357 BLIND BOX  
12" HIGH**

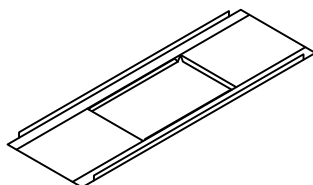

**354 PLASTER FRAME**

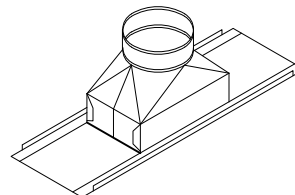

**356 PLASTER FRAME with  
STRAIGHT BOOT INSTALLED**

## INSULATED REGISTER BOOTS & BOXES R-4.2

GALVANIZED STEEL with R-4.2 INTERNAL INSULATION

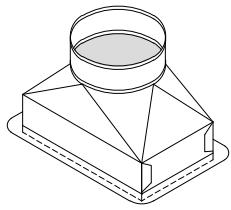

**1242 FRAMED BOOT**

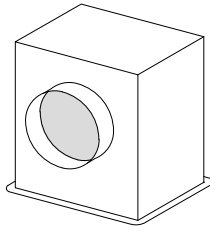

**1269 FRAMED BOX**

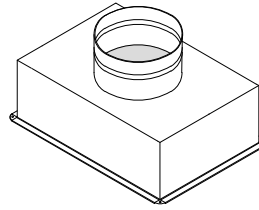

**1275 FRAMED BOX  
4" HIGH**

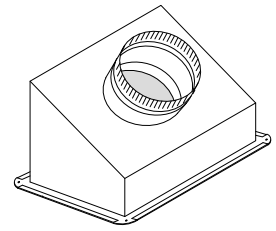

**1293 SLANT TOP  
BOX**

## DUCT BOARD BOXES R-4.2

GALVANIZED STEEL REINFORCED DUCT BOARD BOXES

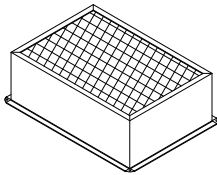

**1288 4" HIGH with FLANGE**  
**1284 4" HIGH without FLANGE**  
(Not Shown)

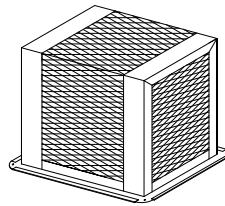

**1292 (11" HIGH)**  
Maximum Side Collar  
8" Round

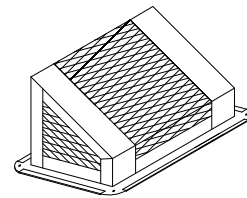

**1298 SLANT TOP BOX**

## INSULATED REGISTER BOOTS & BOXES R-6.0

GALVANIZED STEEL with R-6.0 INTERNAL INSULATION

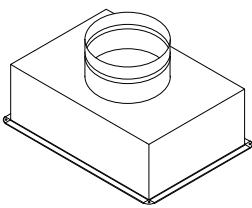

**1575 FRAMED BOX  
SILVER INTERIOR**

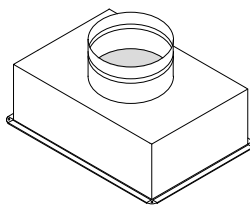

**1580 FRAMED BOX  
BLACK INTERIOR**

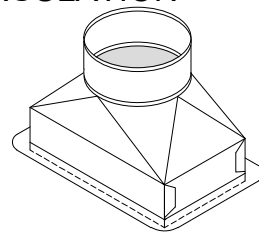

**1242-FL BOOT  
BLACK INTERIOR**

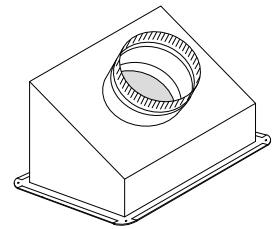

**1293-FL SLANTED TOP  
BLACK INTERIOR**

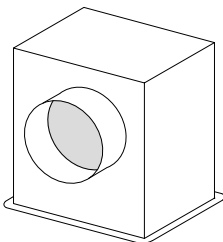

**1269-FL FRAMED BOX  
BLACK INTERIOR**

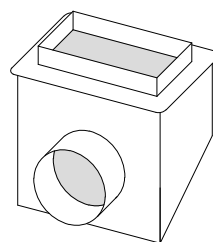

**1243-FL FLOOR BOOT  
BLACK INTERIOR**

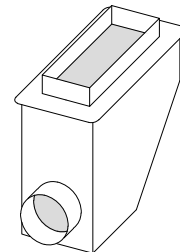

**1244-FL FLOOR BOOT  
BLACK INTERIOR**

## DUCT BOARD BOXES R-6.0

GALVANIZED STEEL REINFORCED DUCT BOARD BOXES  
ALL WITH BLACK INTERIORS

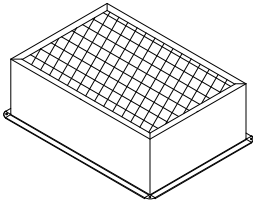

**1288-FL**

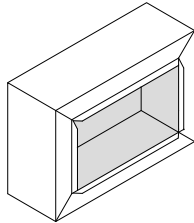

**88**

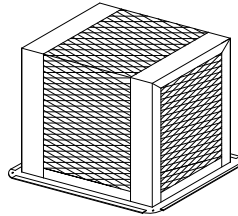

**1292-FL**

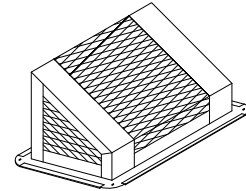

**1298-FL**

## INSULATED REGISTER BOXES R-6.0

WITH THERMA SEAL GASKET

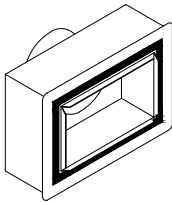

**1575-G FRAMED BOX  
SILVER INTERIOR**

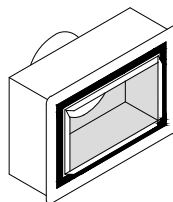

**1580-G FRAMED BOX  
BLACK INTERIOR**

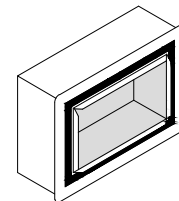

**1288-FLG DUCT BOARD BOX  
BLACK INTERIOR**

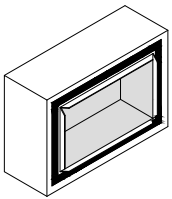

**88-G DUCT BOARD BOX  
BLACK INTERIOR**

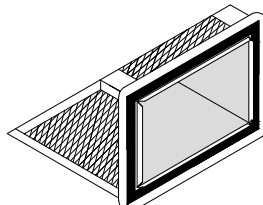

**1298-FLG SLANT TOP BOX  
BLACK INTERIOR**

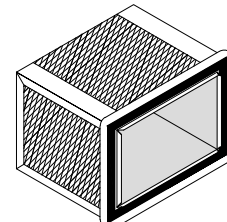

**1292-FLG DUCT BOARD BOX  
BLACK INTERIOR**

Therma Seal Gasket applied for sealing box to building envelope.

## INSULATED REGISTER BOXES R-8.0

WITH BLACK INTERIORS

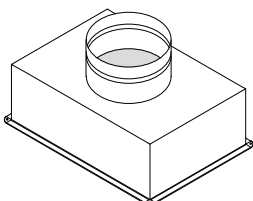

**1780**

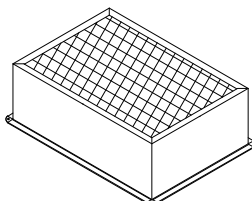

**1788**

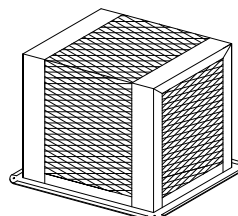

**1792**

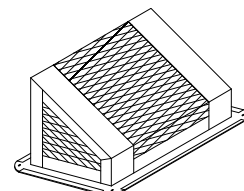

**1798**

# CEILING RADIATION DAMPER BOXES

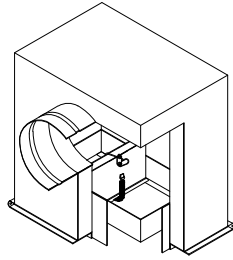

**1565-CRD**  
**CEILING RADIATION DAMPER BOX**  
**SIDE ENTRY COLLAR**

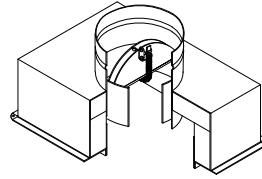

**1575-CRD**  
**CEILING RADIATION DAMPER BOX**  
**TOP ENTRY COLLAR**

- 👑 Galvanized steel with R-6.0 internal insulation.
- 👑 Ready to be installed and connected to supply duct.
- 👑 Hanger brackets optional.
- 👑 One hour rated CRD/Register/Grille assembly with CRD/Plenum Box assembly for use in floor-ceiling & roof-ceiling wood truss assemblies U.L. Design L-563, L-585, P-544, P547.
- 👑 Install with Crown No. 1252 Mounting Bracket (see below) or Crown No. 1260 18 gauge Mounting Angle (see below).
- 👑 No. 1565-CRD: Min. size = 4" x 4" - 4"Ø Max. size = 16" x 16" (256 sq. in.) - 10"Ø
- 👑 No. 1575-CRD: Min. size = 4" x 4" - 4"Ø Max. size = 16" x 16" (256 sq. in.) - 12"Ø

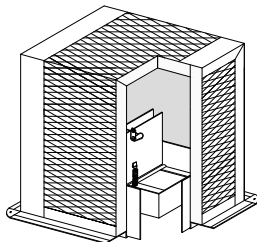

**1292-CRD**  
**CEILING RADIATION DAMPER BOX**  
**R-4.2 DUCT BOARD**

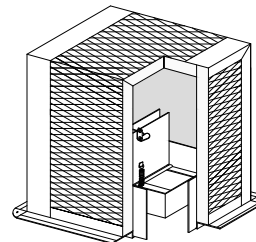

**1592-CRD**  
**CEILING RADIATION DAMPER BOX**  
**R-6.0 DUCT BOARD**

- 👑 Galvanized Steel Frame with Duct Board Top & Sides, Black Interior.
- 👑 Duct Board Top & Sides Allow for Various Collar Inlet Sizes, Field Installed.
- 👑 One hour rated Ceiling Radiation Damper and Fiberglass Plenum Box assembly for use in floor-ceiling & roof-ceiling wood truss assemblies U.L. Design L-563, L-585, P-544, P-547.
- 👑 Install with Crown No. 1252 Mounting Bracket (see below) or Crown No. 1260 18 gauge Mounting Angle (see below).
- 👑 Maximum Register Size = 16" x 16" (Maximum Area 256 sq. in.), Maximum Height = 16", Maximum Collar Size = 10"Ø.

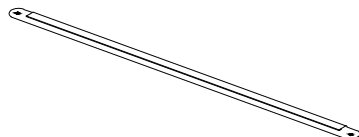

**1250 MOUNTING BRACKET**  
24 GAUGE

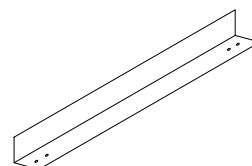

**1260 MOUNTING ANGLE**  
18 GAUGE, 1½" x 1½" x 26" LONG



# STARTING COLLARS

FOR SHEET METAL DUCT

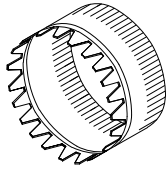

**261 TAB COLLAR**  
3" LONG

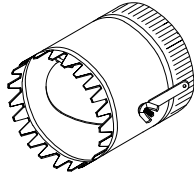

**261-D**  
with DAMPER

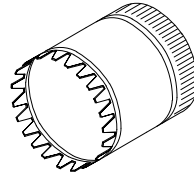

**261-L**  
6" LONG

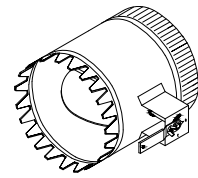

**261-DS**  
DAMPER & 2" STANDOFF

# SPIN-IN COLLARS

FOR SHEET METAL DUCT

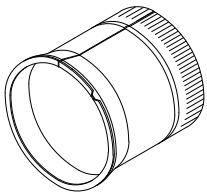

**720**  
CRIMP & BEAD

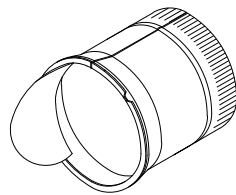

**722**  
with SCOOP

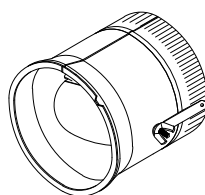

**724**  
with DAMPER

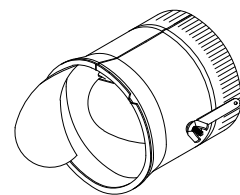

**726**  
with SCOOP  
and DAMPER

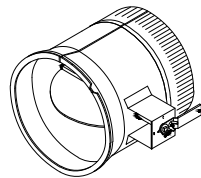

**724-DSO**  
with DAMPER  
and 2" STANDOFF

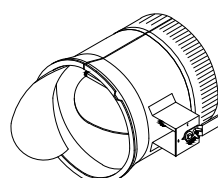

**726-DSO**  
with SCOOP,  
DAMPER and  
2" STANDOFF

# RING SEAL COLLARS

FOR SHEET METAL DUCT

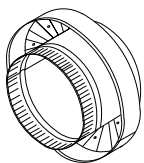

**650 COLLAR**

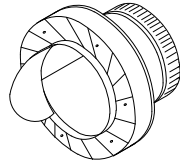

**652 with SCOOP**

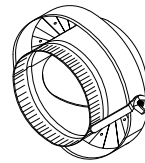

**654 with DAMPER**

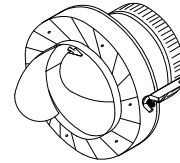

**656 with SCOOP  
and DAMPER**

Ring Seal Collar - No Tabs

Install with sheet metal screws, #8 x 1/2", holes provided.

# TAB COLLARS

FOR 1" and 1½" DUCT BOARD

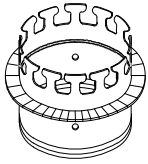

**616**  
TAB COLLAR

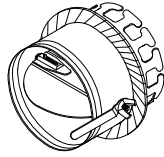

**616-D**  
with DAMPER

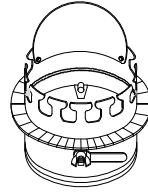

**616-DS**  
with SCOOP  
and DAMPER

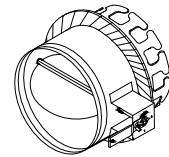

**616-DSO**  
with 2"  
STANDOFF

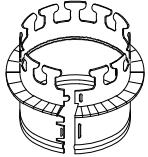

**616-KD**  
NESTED COLLAR

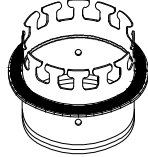

**616-G**  
with GASKET

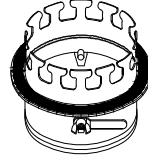

**616-DG**  
with DAMPER  
and GASKET

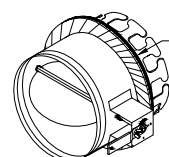

**616-GDSO**  
with GASKET and  
2" STANDOFF

GASKET ON  
OUTBOARD  
FLANGE

# DAMPER SLEEVE, CONNECTOR & INSIDE RING

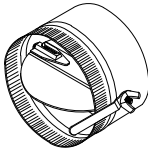

**175** DAMPER  
SLEEVE

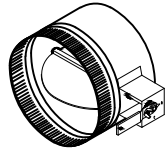

**175-X** DAMPER  
SLEEVE WITH 2"  
STANDOFF

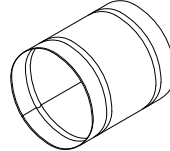

**680**  
FLEX DUCT  
CONNECTOR

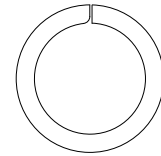

**619**  
INSIDE  
BACK-UP RING

# TWIST LOCK COLLARS

FOR 1" and 1½" DUCT BOARD

"FL" COLLARS FIT 1½" DUCT BOARD

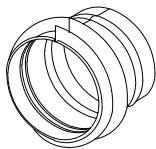

**620 / 620-FL**  
with BEAD

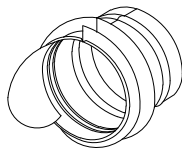

**622 / 622-FL**  
with SCOOP

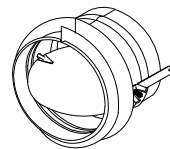

**624 / 624-FL**  
with DAMPER

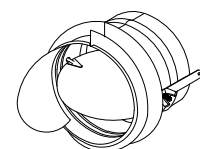

**626 / 626-FL**  
with DAMPER  
and SCOOP

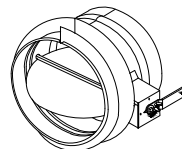

**624-DSO / 624-FL-DSO**  
with DAMPER  
and 2" STANDOFF

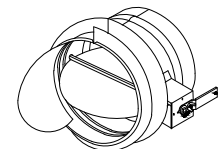

**626-DSO / 626-FL-DSO**  
with SCOOP,  
DAMPER and  
2" STANDOFF

# FLAT TAP COLLARS

WITH THERMA SEAL GASKET  
OFF RECTANGULAR DUCT

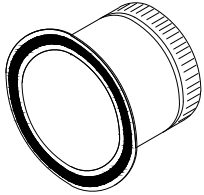

**710 COLLAR**

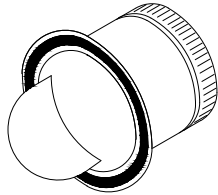

**712 with SCOOP**

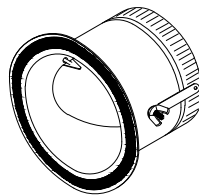

**714 with DAMPER**

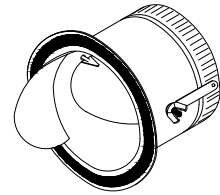

**716 with SCOOP  
and DAMPER**

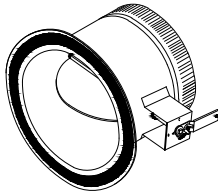

**714-DSO  
with DAMPER  
and 2" STANDOFF**

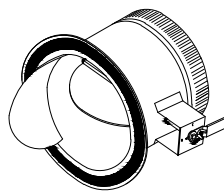

**716-DSO  
with SCOOP,  
DAMPER and  
2" STANDOFF**

# FLAT TAP COLLARS

WITH PEEL OFF PAPER GASKET  
OFF RECTANGULAR DUCT

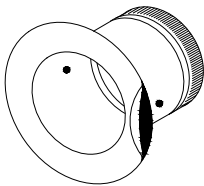

**711 COLLAR**

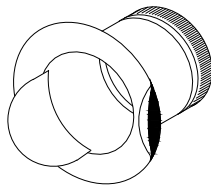

**713 with SCOOP**

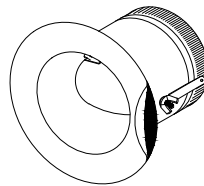

**715 with DAMPER**

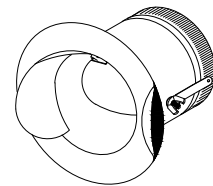

**717 with SCOOP  
and DAMPER**

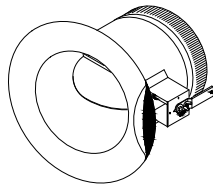

**715-DSO  
with DAMPER  
and 2" STANDOFF**

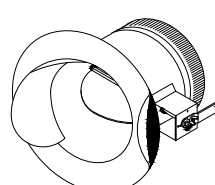

**717-DSO  
with SCOOP,  
DAMPER and  
2" STANDOFF**

# SADDLE TAP COLLARS

WITH THERMA SEAL GASKET  
OFF ROUND PIPE

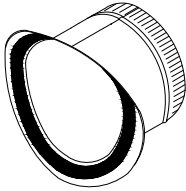

**310 COLLAR**

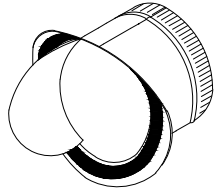

**312 with SCOOP**

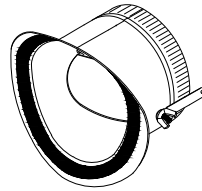

**314 with DAMPER**

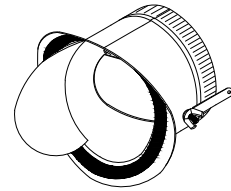

**316 with SCOOP  
and DAMPER**

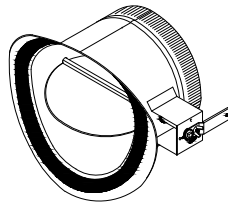

**314-DSO  
with DAMPER  
and 2" STANDOFF**

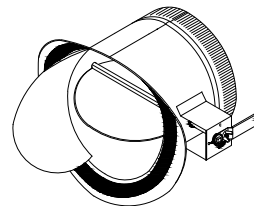

**316-DSO  
with SCOOP,  
DAMPER and  
2" STANDOFF**

# SADDLE TAP COLLARS

WITH PEEL OFF PAPER GASKET  
OFF ROUND PIPE

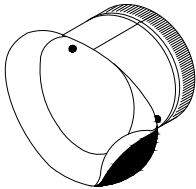

**311 COLLAR**

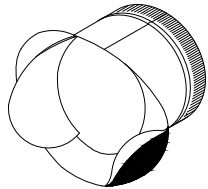

**313 with SCOOP**

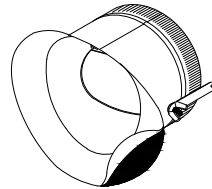

**315 with DAMPER**

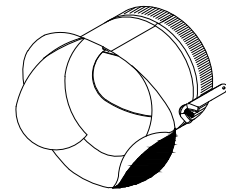

**317 with SCOOP  
and DAMPER**

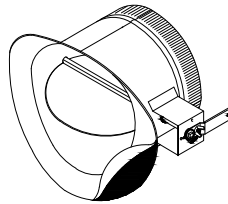

**315-DSO  
with DAMPER  
and 2" STANDOFF**

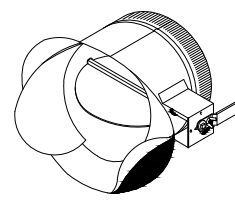

**317-DSO  
with SCOOP,  
DAMPER and  
2" STANDOFF**

# DRYERBOX & EXHAUST VENTS

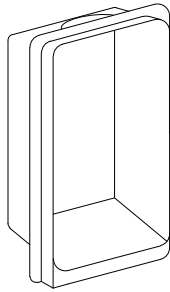

- 700-350 Upflow:** For use in 2 x 4 stud wall
- 700-425 Upflow:** For use in 2 x 6 stud wall
- 700-3D Downflow:** For use in 2 x 4 stud wall
- 700-4D Downflow:** For use in 2 x 6 stud wall
- 700-480 Upflow or Downflow:** For use with Pedestal Dryer (2 x 6 wall)

- 👑 One-piece die stamped 22 gauge aluminized steel (rigid, rust free and paintable).
- 👑 Accepts 4" diameter snaplock pipe for venting to the wall, roof or floor.
- 👑 Eliminates restrictive bends in the flex hose.
- 👑 Dryers can be installed right against the wall.
- 👑 700-350: 6 per carton. 700-425: 5 per carton.  
700-3D: 6 per carton. 700-4D: 5 per carton.  
700-480: 5 per carton.

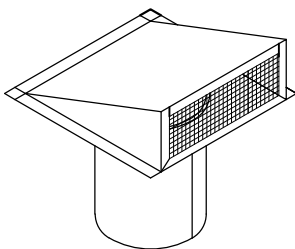

## SIDEWALL VENTS

- 349 VENT** with Screen (Shown)
- 349-D VENT** with Flapper Damper
- 349-SD VENT** with Screen & Damper

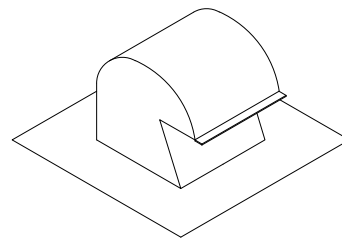

## 350 ROOF CAP

- 👑 **350** supplied with round collar in bottom plate and screen in top opening.
- 👑 **350-D** supplied with round collar in bottom plate and gravity damper (no screen).
- 👑 **350-R** supplied with rectangular hole in bottom plate and screen in top opening.
- 👑 **350-RD** supplied with rectangular hole in bottom plate and gravity damper (no screen).
- 👑 **350-DS** and **350-RDS** with damper and screen.

# INSTALLATION ACCESSORIES

## 301- CB UNIT STAND

- 👑 24 gauge Galvanized Steel. R-6 Internal Insulation.
- 👑 20" tall, 22 gauge 1" x 2" x 1" channel for C/L bracing/support.

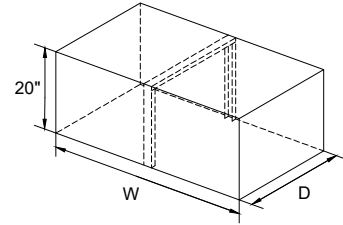

## 301- SM UNIT STAND

- 👑 26 gauge Galvanized Steel.
- 👑 R-6 internal insulation.
- 👑 Recessed flange at top allows for securing Air Handler to stand.

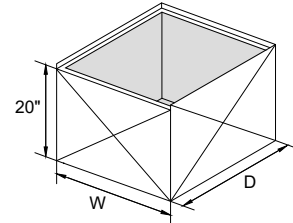

## 301- DB UNIT STAND

- 👑 24 gauge Galvanized Steel frame and bottom.
- 👑 R-6 duct board sides and bottom.
- 👑 Recessed flange at top allows for securing Air Handler to stand.

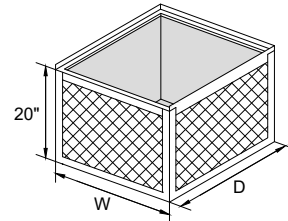

## 500 ADJUSTABLE RETURN AIR STAND

- 👑 Stand fits most 1½ through 3 ton Air Handlers.
- 👑 18 gauge Galvanized Steel with spot welded seams.
- 👑 Built in Filter Rack.
- 👑 18" High, 22" Deep, 14" - 25" Adjustable Width Dimension.

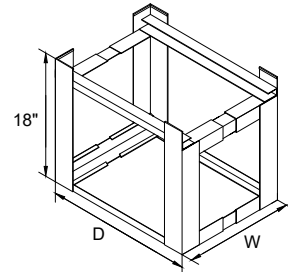

## 600 ADJUSTABLE AIR HANDLER STAND

- 👑 2-Way Adjustable. 18" High. 1" Filter Channel.
- 👑 14" - 25" Adjustable Width Dimension.
- 👑 17" - 27" Adjustable Depth Dimension.
- 👑 Shipped Knocked Down Flat in Carton with Assembly Hardware.
- 👑 Welded Tube Construction, Powder Coat Paint.

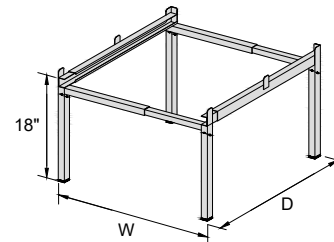

## CONDENSING UNIT TIE DOWN BRACKET

- 👑 14 Gauge Galvanized Steel, Hot Dipped AFTER Punching.
- 👑 Slotted Holes for Easy Installation.
- 👑 Packaged 4 Brackets per Pack, 50 Packs per Box.
- 👑 Engineering Data Provided in each Pack.
- 👑 Brackets are 1" Wide & Powder Coated, 556-2 is 2" Wide x 6" Long & Powder Coated.

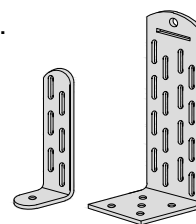

**554 4" Long**  
**556 6" Long**  
**556-2 6" Long**  
**558 8" Long**

# INSTALLATION ACCESSORIES

## 301- R RADIUS PLENUM

- ✦ 26 gauge Galvanized Steel, 21" Tall.
- ✦ Internally insulated with R-6 liner.
- ✦ Sized to fit air handler.

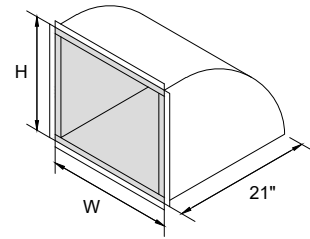

## 750 DRAIN PAN

- ✦ Available in 26 gauge and 24 gauge Galvanized Steel.
- ✦ One 3/4" female PVC nipple installed in the center of short side unless specified otherwise.

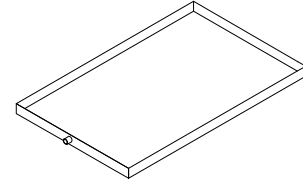

## 757 DRAIN PAN with SUPPORTS

- ✦ 24 gauge Galvanized Steel.
- ✦ 20 gauge support rails for placement of horizontal Air Handler.
- ✦ Options: With or without 3/4" female nipple - standard location is C/L long side. Eyebolts or "S" hooks for suspending unit are available.

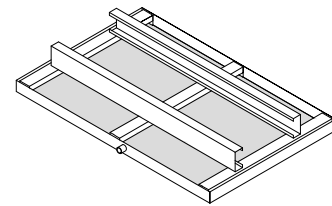

## 667 PACKAGE UNIT ADAPTERS, SUPPLY & RETURN

- ✦ 26 gauge Galvanized Steel.
- ✦ 1" deep panel sized to fit supply and return air openings. Collar diameter 1/8" undersized. 1" internal insulation.
- ✦ Packaged as kit - supply and return adapters.

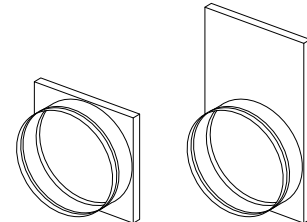

## PL- 4 PLENUM BOX LEG

- ✦ 22 gauge Galvanized Steel. 3" x 3" tapered leg 4" long.
- ✦ Ideal for 301-CB, 301-SM and 301-DB plenum boxes.



## R-6 DUCT BOARD TRIANGLE BOXES

- ✦ Assembled with staples and UL SMACNA Tape.
- ✦ Four sizes available.

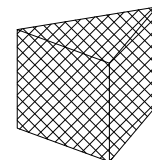

## R-6 DUCT BOARD REDUCER BOXES

- ✦ Assembled with staples and UL SMACNA tape.
- ✦ Four sizes available.

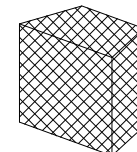

# INSTALLATION ACCESSORIES

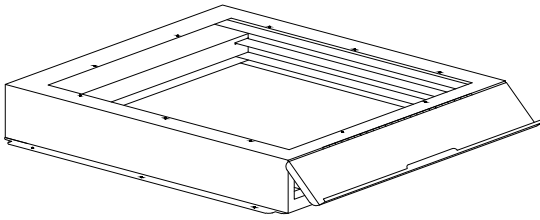

- 👑 Fits Air Handlers & Furnaces through 5 tons.
- 👑 22 Gauge Galvanized Steel.
- 👑 Fully Hinged Door - Magnetic Closure.
- 👑 Series 3 Accepts 1" or 2" Thick Filters.
- 👑 Series 6 Accepts 1", 2" or 4" Thick Filters.

## FILTER HOUSING FOR AIR HANDLERS & GAS FURNACES

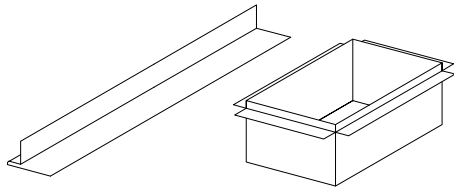

**612 CAN STOCK**  
30 Gauge Galvanized Steel  
10 ft. lengths or cut-to-size

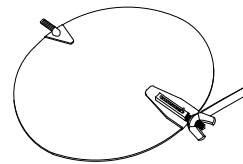

**275 MANUAL VOLUME DAMPER**

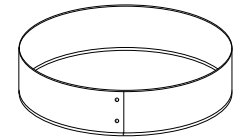

**273 END CAP**

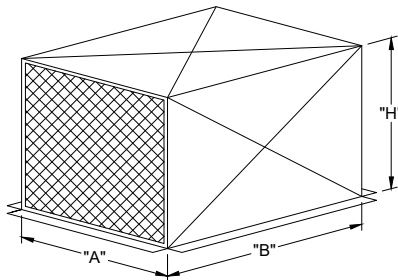

## 550 CONDENSING UNIT COVER

- 👑 24 Gauge Galvanized Steel (sides and top).
- 👑 Expanded Metal in both "A" x "H" openings.

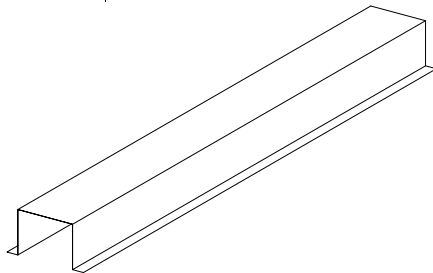

**560 LINE COVER**

Available in 8-ft. and 10-ft. lengths, 28 gauge and 26 gauge Galvanized Steel.

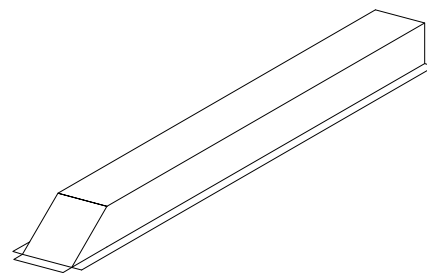

**565 LINE COVER with CAP**

**461 EXPAND-O-DUCT**  
8" x 8" - 14" x 14"

**465 EXPAND-O-DUCT**  
12" x 12" - 22" x 22"

**469 EXPAND-O-DUCT**  
16" x 16" - 30" x 30"

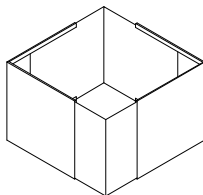

- 👑 Ideal as inside liner for fiberglass duct to support fire damper.
- 👑 22 gauge Galvanized Steel, 11" long.
- 👑 Edges interlock - no cutting necessary.



# INSTALLATION ACCESSORIES

## 301 PLENUM - GALVANIZED STEEL

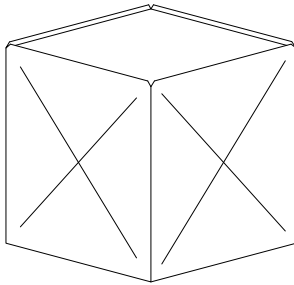

- 👑 Internal Insulation Available: ½" x 2# Density Liner  
1" x 1.5# Density Liner  
2" x 1.5# Density Liner
- 👑 Plenums are available in 28 gauge thru 22 gauge.
- 👑 Button punch snaplock seam construction (4 sides) and recessed end cap standard.
- 👑 Plenums are shipped knocked-down (5 pieces) and strapped.

## 480 RECTANGLE TO ROUND TRANSITION

- 👑 Galvanized Steel
- 👑 Available with crimp and bead collar for flexible duct attachment.
- 👑 Transitions to 12" diameter and smaller fabricated from 28 gauge galvanized steel.
- 👑 Transitions to 14" diameter and larger fabricated from 26 gauge galvanized steel.
- 👑 Center-line taper is standard for Transitions. If "flat on one side" style taper is required, note the side to be flat as the first size given. For example, order size 20" x 16" - 12" rd. F.O.B. and the Transition will be flat on the 20" side.

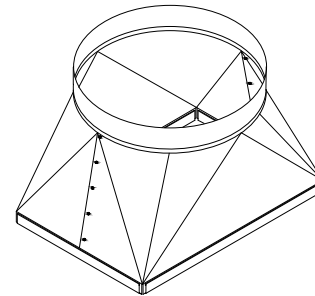

## 1480 RECTANGLE TO ROUND TRANSITION

- 👑 Galvanized Steel
- 👑 Internally insulated with duct liner, R-4.2
- 👑 Transitions to 12" diameter and smaller fabricated from 28 gauge galvanized steel.
- 👑 Transitions to 14" diameter and larger fabricated from 26 gauge galvanized steel.
- 👑 Collar crimped and beaded for flexible duct connection.
- 👑 4" straight-away on rectangular end.
- 👑 Galvanized Steel sleeve inside - required by code.

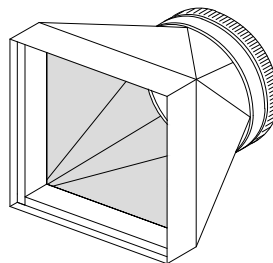

## 1480-FL RECTANGLE TO ROUND TRANSITION

- 👑 Galvanized Steel
- 👑 Internally insulated with duct liner, R-6.0
- 👑 Transitions to 12" diameter and smaller fabricated from 28 gauge galvanized steel.
- 👑 Transitions to 14" diameter and larger fabricated from 26 gauge galvanized steel.
- 👑 Collar crimped and beaded for flexible duct connection.
- 👑 4" straight-away on rectangular end.
- 👑 Galvanized Steel sleeve inside - required by code.

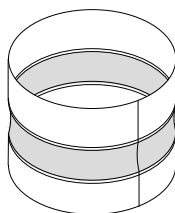

## 412-R FLEX CONNECTOR FOR ROUND END OF 480, 1480 AND 1480-FL

## PASSIVE RETURN AIR SLEEVES

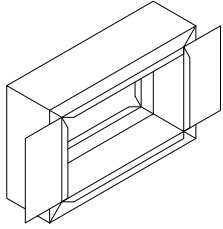

**"PR" PASSIVE RETURN AIR SLEEVE**

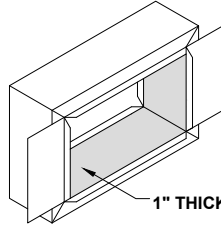

**"SK" SILENT KNIGHT PASSIVE RETURN AIR SLEEVE**

1" THICK ACOUSTICAL LINER

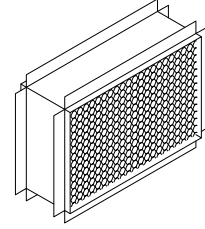

**"RAP" RETURN AIR PATHWAY KIT**

## DUCT HANGERS

### 795 DUCT HANGER STRAP

Galvanized Steel  
1" and 2" wide, 10-ft. long  
Available in 28 ga., 26 ga., 24 ga.

### 798 DUCT HANGER STRAP

Galvanized Steel  
1.5" wide x 100-ft. roll  
Available in 26 ga.

### 792 TYING WIRE

18 gauge Galvanized  
830-ft. Handi-Reel

### 777 DUCT HANGER STRAP

.019" thick Aluminum  
1" x 200-ft. roll

### 697 DUCT BOARD HANGER CHANNEL

Galvanized Steel  
10-ft. long  
Available in 26 ga. and 22 ga.

### 797 DUCT HANGER STRAP

Galvanized Steel  
1" wide x 100-ft. roll  
Available in 26 ga. and 22 ga.

### 799 DUCT HANGER STRAP

Galvanized Steel  
2" wide x 100-ft. roll  
Available in 28 ga., 26 ga., 24 ga.

### 793 ANGLE

Galvanized Steel  
Available in 30 ga. and 26 ga.

### 778 DUCT HANGER STRAP

.019" thick Aluminum  
1" x 100-ft. roll

### 695 SADDLE HANGER for DUCT BOARD

22 ga. Galvanized Steel  
4" wide, 2" x 2" angle

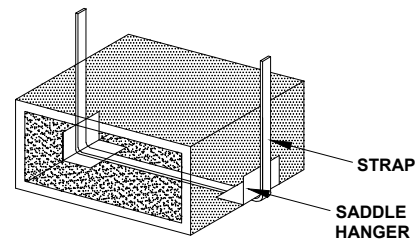
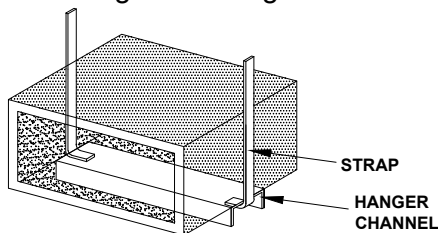

## MOUNTING BRACKETS

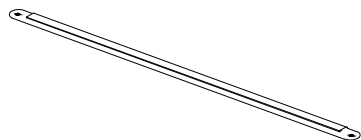

### 1250 MOUNTING BRACKET

Clip-on bracket for use with flanged Boots and Boxes  
25" long, 24 ga. Galvanized

### 1252 MOUNTING BRACKET

Clip-on bracket for use with flanged Boots and Boxes  
25" long, 26 ga. Galvanized

### 1250-16 MOUNTING BRACKET

Clip-on bracket for use with flanged Boots and Boxes  
17" long, 24 ga. Galvanized

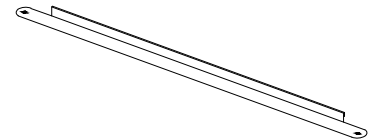

### 1254 MOUNTING BRACKET

Screw-on bracket for use with unflanged Boots and Boxes  
25" long, 26 ga. Galvanized

# VENT TOPS & FLASHINGS

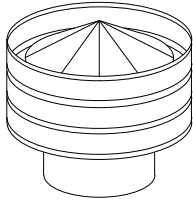

**332 VENT TOP  
with WIND BAND**

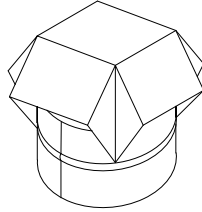

**334 VENT TOP**

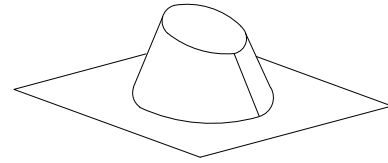

**336 ROOF FLASHING**

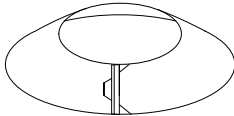

**339 STORM COLLAR**

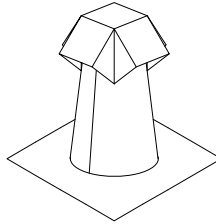

**341 ROOF JACK  
for FLAT ROOF (Shown)**

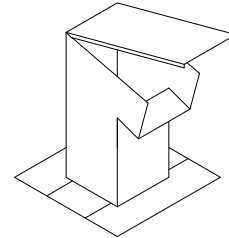

**353 ROOF JACK  
for REFRIGERANT LINES**

**341-P ROOF JACK  
for PITCHED ROOF**

# WALLSTACK & FITTINGS

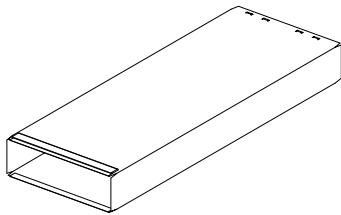

**201 WALLSTACK DUCT**

Wallstack duct is furnished in half sections, nested and strapped. 5 joints per bundle. Supplied with button lock side seams. 28 ga. Galvanized Steel.

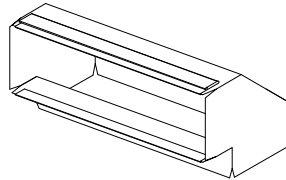

**240 90° ELBOW  
SHORT WAY (Shown)**  
**(245 45° ELBOW  
SHORT WAY)**

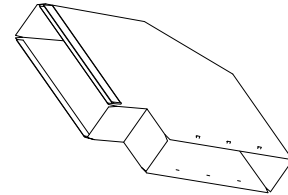

**230 90° ELBOW  
LONG WAY (Shown)**  
**(235 45° ELBOW  
LONG WAY)**

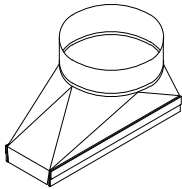

**231 STRAIGHT BOOT**

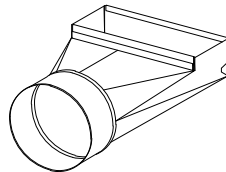

**233 90° ANGLE BOOT**

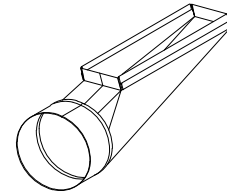

**234 CENTER END BOOT**

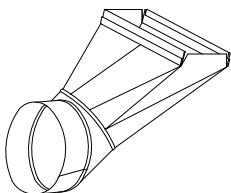

**236 ADJUSTABLE  
OFFSET BOOT**

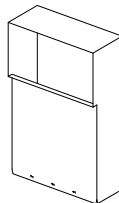

**223 STACKHEAD (12" THROAT)**  
**222 STACHHEAD (7" THROAT)**

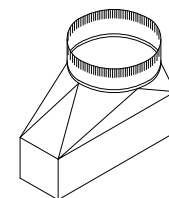

**232 RANGE HOOD  
TRANSITION**  
3" RECTANGULAR STRAIGHTAWAY

# MOBILE HOME DUCT ACCESSORIES

## SUPPLY AIR

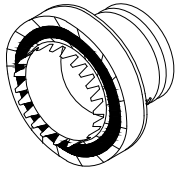

**920 SUPPLY CONNECTOR**  
with GASKET and DAMPER

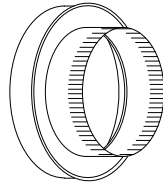

**925 BUSHING**

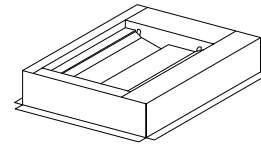

**935 DAMPER SECTION**  
(To fit beneath furnace.  
Top is removable to be used flat.)

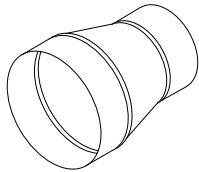

**265 TAPERED REDUCER**

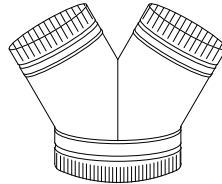

**965 WYE**

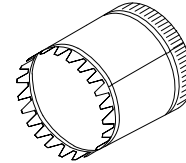

**261-L STARTING COLLAR**  
6" LONG

## RETURN AIR

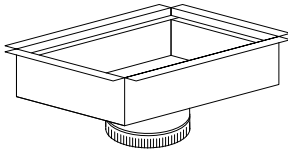

**900 RETURN AIR BOX**  
6" DEEP with RACK for one FILTER

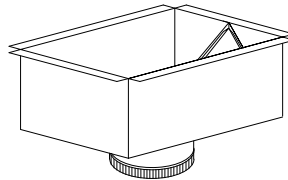

**905 RETURN AIR BOX**  
10" DEEP with "A" RACK for two FILTERS

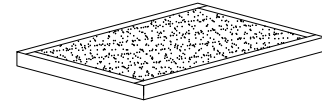

**945 FILTER**

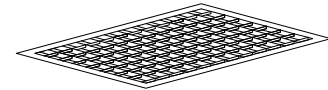

**950 FLOOR GRILLE**

# MOBILE HOME DUCT KITS

**971 SINGLE WIDE DUCT KIT, consisting of:**

- 905 1 ea. R/A Box 12" x 20" - 14" oval
- 950 1 ea. 12" x 20" Floor Grille
- 945 2 ea. 10" x 20" x 1" Filter
- 920 1 ea. 12" Supply Connector

**972 SINGLE WIDE DUCT KIT, consisting of:**

- 905 1 ea. R/A Box 12" x 20" - 12" round
- 950 1 ea. 12" x 20" Floor Grille
- 945 2 ea. 10" x 20" x 1" Filter
- 920 1 ea. 12" Supply Connector

**974 SINGLE WIDE DUCT KIT, consisting of:**

- 905 1 ea. R/A Box 12" x 20" - 14" oval
- 950 1 ea. 12" x 20" Floor Grille
- 945 2 ea. 10" x 20" x 1" Filter
- 261-L 1 ea. 12" Starting Collar





**976 DOUBLE WIDE DUCT KIT, consisting of:**

- 905 1 ea. R/A Box 12" x 20" - 14" oval
- 950 1 ea. 12" x 20" Floor Grille
- 945 2 ea. 10" x 20" x 1" Filter
- 920 2 ea. 10" Supply Connector
- 965 1 ea. 12" x 10" x 10" Wye

# COMMERCIAL DUCT PRODUCTS



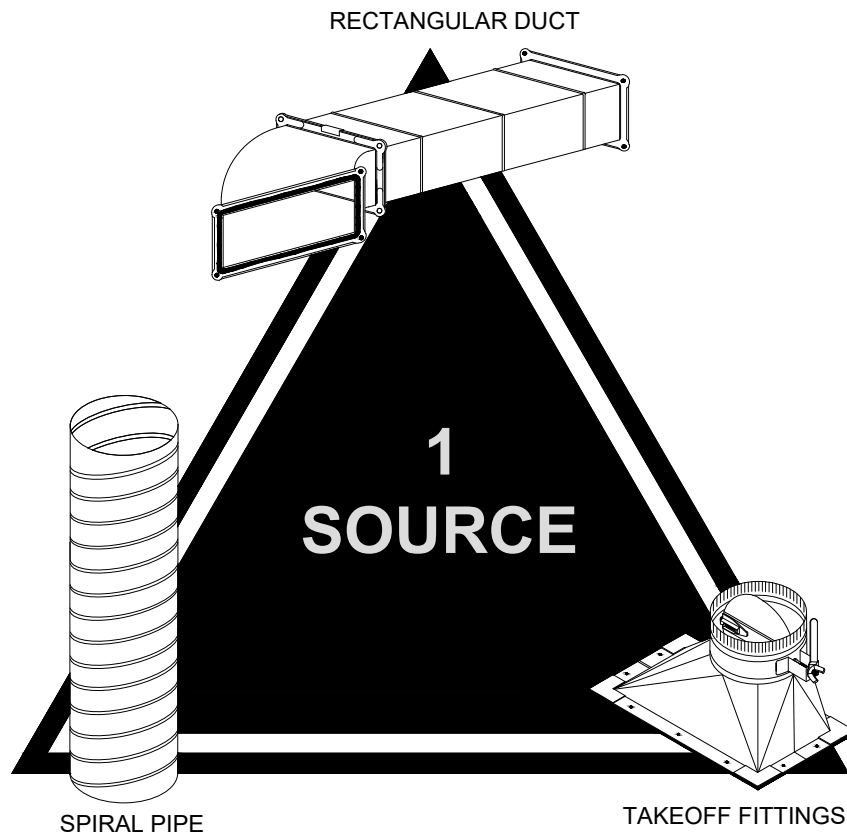

## LET CROWN BE YOUR FULL-SERVICE COMMERCIAL DUCT PROVIDER

### IT'S EASY TO GET GOING

-  You share your blueprints, material list or shop drawings with your Crown distributor.
-  No-cost quotes via Crown's Automated Estimating Program.
-  Job initiated and scheduled per your delivery goal.
-  Job site trailers available for large or multiple shipment jobs.



### QUALITY CONSTRUCTION & CUSTOM SPECIFICATIONS WITH EVERY SHIPMENT

-  Commercial duct work is available in galvanized, paint-grip, and stainless steel.
-  Rectangular duct is available insulated with internal duct liner.
-  Rectangular and round duct is available in custom lengths to accommodate various job conditions.
-  All duct work is labeled for easy identification.

# RECTANGULAR DUCT WORK

## S-LOCK & DRIVE TRANSVERSE CONNECTION

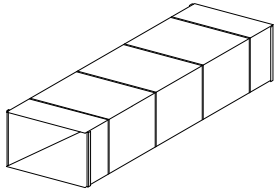

**401 RECTANGULAR DUCT**

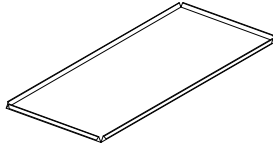

**411 END CAP**

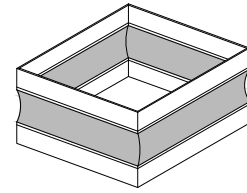

**412 FLEX CONNECTOR**

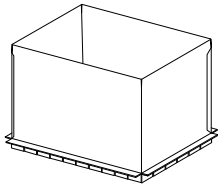

**406 STARTING COLLAR**

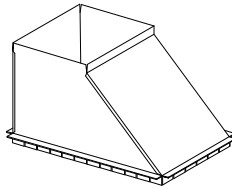

**408 BOOT TAP**

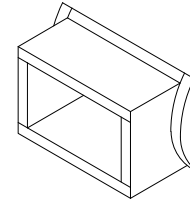

**406-R GRILLE TAP**

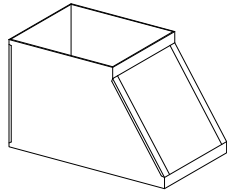

**416 REDUCER**

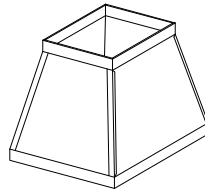

**420 TRANSITION**

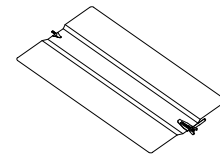

**422 MANUAL VOLUME DAMPER**

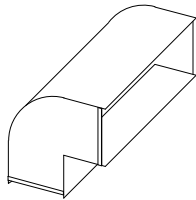

**440 SHORT WAY 90° ELBOW**

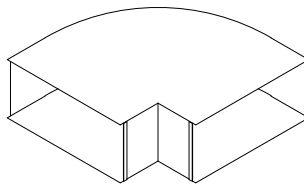

**430 LONG WAY 90° ELBOW**

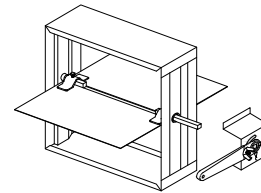

**422-XS MANUAL VOLUME DAMPER**

**445 SHORT WAY 45° ELBOW**  
(NOT SHOWN)

**435 LONG WAY 45° ELBOW**  
(NOT SHOWN)

# RECTANGULAR DUCT TYPE B

## FLANGED BOLT TOGETHER TRANSVERSE CONNECTION

### 800 SERIES TYPE B DUCT

Type B Duct is furnished in half sections ready to assemble.

Type B Duct fittings, reducers, transitions, and elbows are furnished assembled ready to install.

Type B Duct sections are furnished in two standard lengths, 56 ¼" and 44 ¼". Shorter lengths supplied as required.

Type B Duct sections are easily joined by four bolts/nuts (supplied). With the use of butyl gasket (supplied) no fabric and mastic are needed to assure air tight transverse joints.

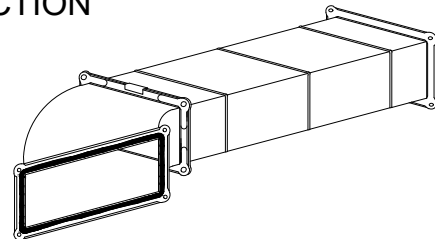

RECTANGULAR DUCT AVAILABLE WITH INTERNAL INSULATION.

CONTACT OUR COMMERCIAL DUCT DIVISION (800-818-7144) FOR PRICING AND AVAILABILITY.

## TURNING VANE & RAIL

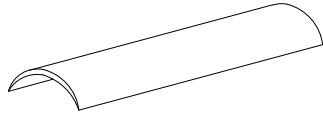

**490 4" TURNING VANE**  
 24 Gauge Double Wall  
 5 1/2" Overall Width  
 10 ft. Sections

**496 2" TURNING VANE**  
 26 Gauge Double Wall  
 10 ft. Sections

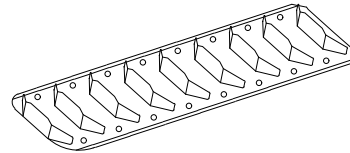

**492 4" VANE RAIL**  
 24 Gauge  
 10 ft. Sections

**498 2" VANE RAIL**  
 24 Gauge  
 10 ft. Sections

No. 496 2" Turning Vane is available on *special order basis*. Allow additional lead time.

## TRANSVERSE DUCT CONNECTORS

AVAILABLE IN 5-ft. OR 10-ft. LENGTHS

PACKAGED 100-ft. PER BUNDLE

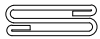

**FLAT S-LOCK**

1028 28 GA.  
 1026 26 GA.  
 1024 24 GA.

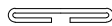

**FLAT DRIVE**

1228 28 GA.  
 1226 26 GA.  
 1224 24 GA.

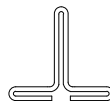

**STANDING DRIVE**

1624 24 GA.  
 1622 22 GA.  
 1620 20 GA.

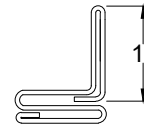

**STANDING S-LOCK**

1126 26 GA.  
 1124 24 GA.

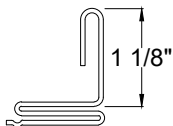

**1" STANDING BAR-LOCK**

1324 24 GA.  
 1322 22 GA.  
 1320 20 GA.

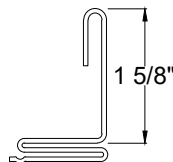

**1 1/2" STANDING BAR-LOCK**



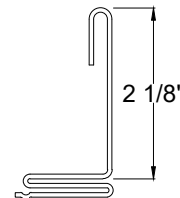



1424 24 GA.  
 1422 22 GA.  
 1420 20 GA.



**2" STANDING BAR-LOCK**

1524 24 GA.  
 1522 22 GA.  
 1520 20 GA.

## SLOT DIFFUSER PLENUMS



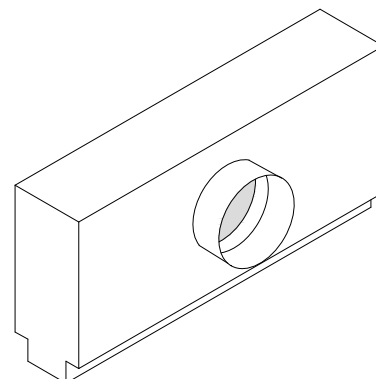

-  26 Gauge Galvanized Steel, Standard
-  1" x 1.5 lb. Density Internal Insulation, Standard
-  10" Standard Height
-  Plenum Length: 5-ft. and under
-  Round Collars Sized 4" through 9" Diameter
-  Oval Collars Sized 10" and Larger Diameter
-  Rectangular End Treatment as Required by Diffuser Spec



**2001 SLOT DIFFUSER PLENUM**

# SINGLE WALL SPIRAL DUCT WORK

## SINGLE WALL SPIRAL PIPE & FITTINGS

-  Standard: Galvanized Steel sheet per ASTM A653, CS Type B.
-  Optional: Galvannealed Steel sheet (paintable) per ASTM A653. Coating designation A40.
-  Optional: Stainless Steel Type 304-2B.
-  Pipe diameters are nominal. Fittings are fabricated  $\frac{1}{8}$ " undersized.

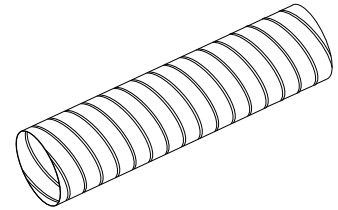

**SP6101 SPIRAL PIPE**  
4" - 48" Diameter  
10 ft. Jts. Standard

**Steel Gauges:**

Diameter	Pipe	Fittings
4" - 14"	26 ga.	24 ga.
16" - 26"	24 ga.	22 ga.
28" - 48"	22 ga.	20 ga.

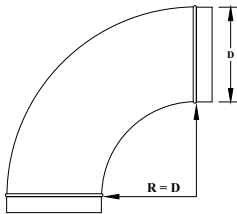

**SP6111 90° ELBOW**  
4" - 12" Die Stamped

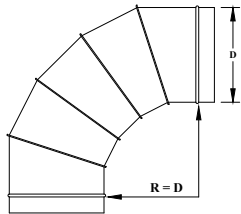

**SP6111 90° ELBOW**  
14" - 48" 5 Piece  
Gorelock

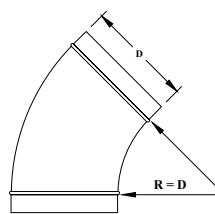

**SP6121 45° ELBOW**  
4" - 12" Die Stamped

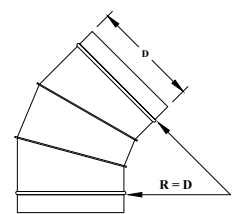

**SP6121 45° ELBOW**  
14" - 48" 3 Piece  
Gorelock

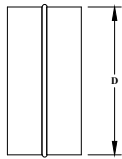

**SP6680 COUPLING**  
6" Long

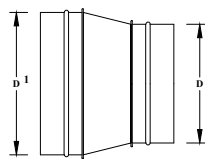

**SP6265 REDUCER**

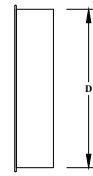

**SP6273 END CAP**

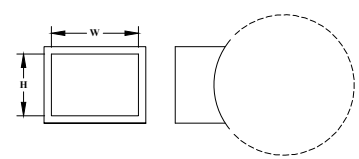

**SP6406 GRILLE TAP**

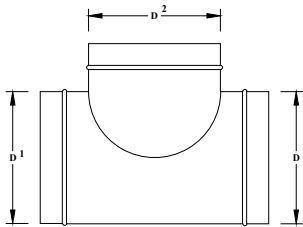

**SP6271 90° TEE**

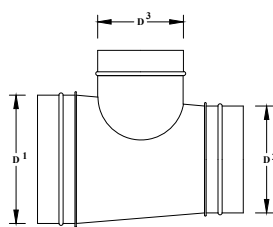

**SP6271R REDUCING  
TEE**

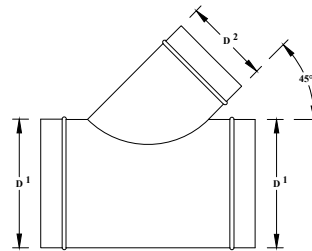

**SP6276 45° LATERAL**

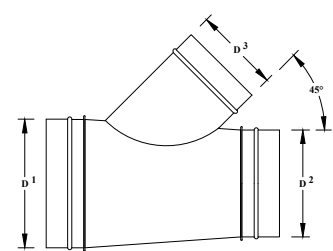

**SP6276R REDUCING  
LATERAL**

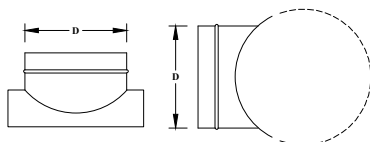

**SP6307 90° SADDLE TAP**

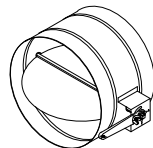

**SP6175 DAMPER SLEEVE**

CONTACT OUR COMMERCIAL DUCT  
DIVISION (800-818-7144) FOR  
SPECIFICATIONS, PRICING AND  
AVAILABILITY.



# SINGLE WALL SPIRAL DUCT WORK with The *EDGE*<sup>®</sup> GASKET SYSTEM

The *EDGE*<sup>®</sup> System eliminates the sealing of all connections in your spiral pipe system. This system will not only provide labor savings for the installer, it is also great for exposed systems.

## FEATURES

All fittings have a factory installed EPDM gasket, which has an operating temperature range of -20° F to 212° F. The smoke and flame spread rating is 0/0.

The gasket construction is machine applied black EPDM wiper base and green EPDM hollow seal that will act as the sealing section.

The *EDGE*<sup>®</sup> System has been tested in accordance to SMACNA's Air Duct Leakage Test Manual and meets SMACNA Class 3 leakage standards.

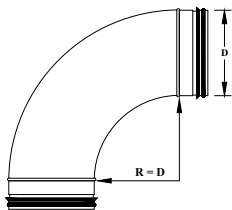

**E6111 90° ELBOW**  
4" - 12" Die Stamped

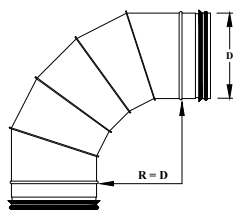

**E6111 90° ELBOW**  
14" - 36" 5 Piece  
Gorelock

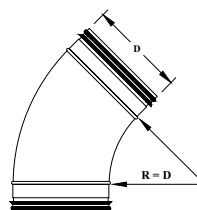

**E6121 45° ELBOW**  
4" - 12" Die Stamped

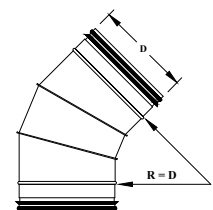

**E6121 45° ELBOW**  
14" - 36" 3 Piece  
Gorelock

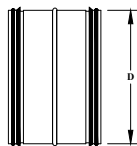

**E6680 COUPLING**

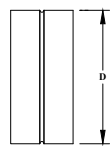

**SP6681 FITTING  
COUPLING**

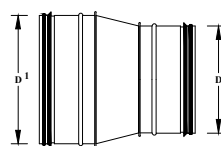

**E6265 REDUCER**

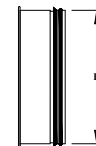

**E6273 END CAP**

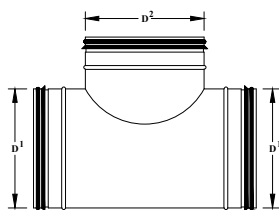

**E6271 90° TEE**

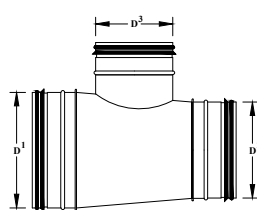

**E6271R REDUCING  
TEE**

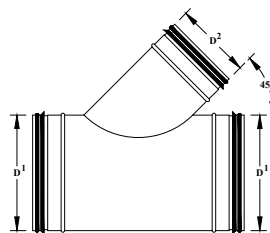

**E6276 45° LATERAL**

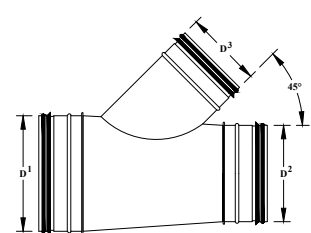

**E6276R REDUCING  
LATERAL**

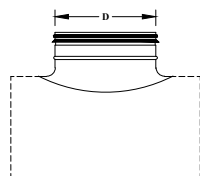

**E6307 SADDLE TAP**

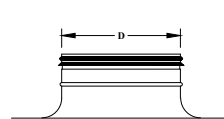

**E3210 BELLMOUTH**

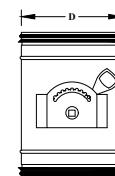



**E6175 DAMPER  
SLEEVE**

CONTACT OUR COMMERCIAL DUCT DIVISION (800-818-7144) FOR PRICING AND AVAILABILITY.

# SINGLE WALL FLAT OVAL SPIRAL DUCT WORK

## SINGLE WALL FLAT OVAL SPIRAL PIPE & FITTINGS

-  Standard: Galvanized Steel sheet per ASTM A653, CS Type B.
-  Optional: Galvannealed Steel sheet (paintable) per ASTM A653. Coating designation A40.
-  Flat Oval Duct is for positive pressure applications only.

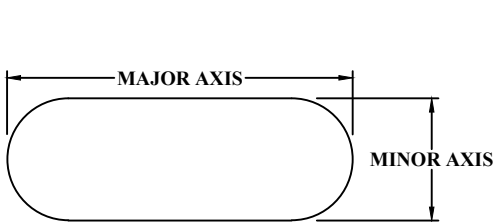

**FO6101** FLAT OVAL PIPE

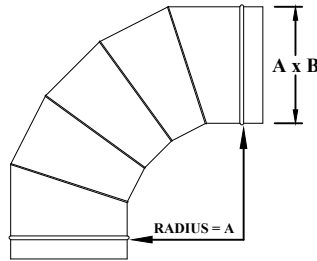

**FO6111** HARD BEND 90° ELBOW

"A" = MAJOR AXIS DIMENSION.  
"B" = MINOR AXIS DIMENSION.

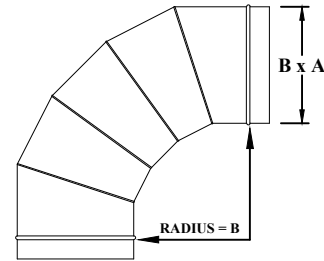

**FO6112** EASY BEND 90° ELBOW

"B" = MINOR AXIS DIMENSION.  
"A" = MAJOR AXIS DIMENSION.

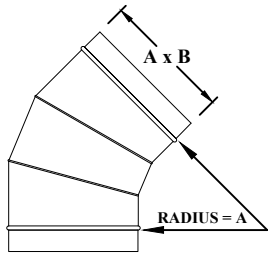

**FO6121** HARD BEND 45° ELBOW

"A" = MAJOR AXIS DIMENSION.  
"B" = MINOR AXIS DIMENSION.

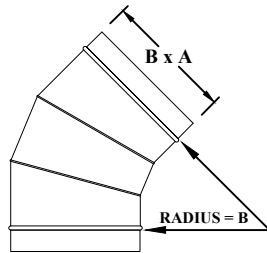

**FO6122** EASY BEND 45° ELBOW

"B" = MINOR AXIS DIMENSION.  
"A" = MAJOR AXIS DIMENSION.

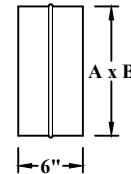

**FO6680** COUPLING

"A" = MAJOR AXIS DIMENSION.  
"B" = MINOR AXIS DIMENSION.

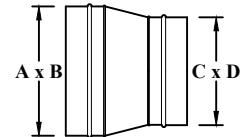

**FO6265** REDUCER

"A" & "C" = MAJOR AXIS DIMENSION.  
"B" & "D" = MINOR AXIS DIMENSION.

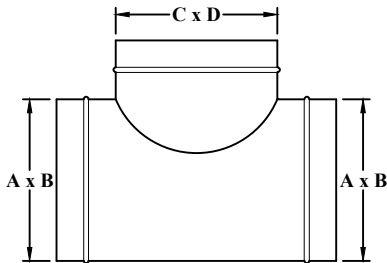

**FO6271** 90° TEE

"A" & "C" = MAJOR AXIS DIMENSION.  
"B" & "D" = MINOR AXIS DIMENSION.

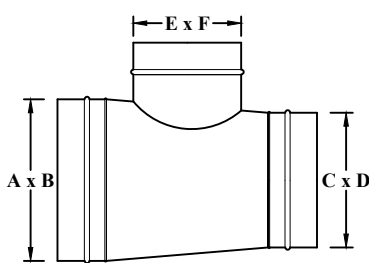

**FO6271R** REDUCING 90° TEE

"A", "C" & "E" = MAJOR AXIS DIMENSION.  
"B", "D" & "F" = MINOR AXIS DIMENSION.

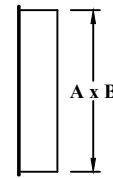

**FO6273** END CAP

"A" = MAJOR AXIS DIMENSION.  
"B" = MINOR AXIS DIMENSION.

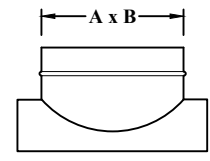

**FO6307** 90° SADDLE TAP

"A" = MAJOR AXIS DIMENSION.  
"B" = MINOR AXIS DIMENSION.

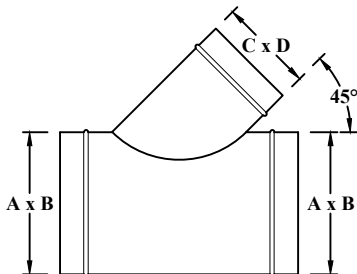

**FO6276** 45° LATERAL

"A" & "C" = MAJOR AXIS DIMENSION.  
"B" & "D" = MINOR AXIS DIMENSION.

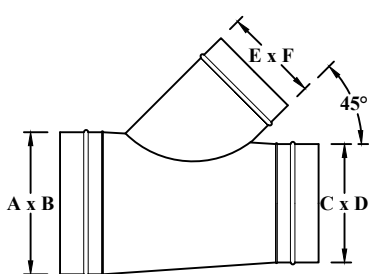

**FO6276R** REDUCING 45° LATERAL

"A", "C" & "E" = MAJOR AXIS DIMENSION.  
"B", "D" & "F" = MINOR AXIS DIMENSION.

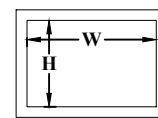

**FO6406** GRILLE TAP



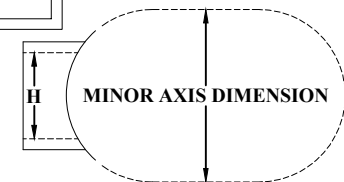



W x H = GRILLE DIMENSIONS.  
TO FIT MINOR AXIS DIMENSION.



CONTACT OUR COMMERCIAL DUCT DIVISION (800-818-7144) FOR SIZES, GAUGES, SPECIFICATIONS, PRICING AND AVAILABILITY.

# DOUBLE WALL SPIRAL DUCT WORK

## DOUBLE WALL SPIRAL PIPE & FITTINGS

-  Outer wall Galvanized Steel sheet per ASTM A653, CS Type B.
-  Outer wall (optional) Galvannealed Steel sheet (paintable) per ASTM A653. Coating designation A40.
-  Outer wall (optional) Stainless Steel Type 304 2B
-  Pipe inner wall Galvanized Perforated Steel.
-  Outboard flange transverse connection.
-  Steel Gauges: (outer wall)
 

Diameter I.D.	Pipe	Fittings
6" - 14"	26 ga.	24 ga.
16" - 26"	24 ga.	22 ga.
28" - 46"	22 ga.	20 ga.

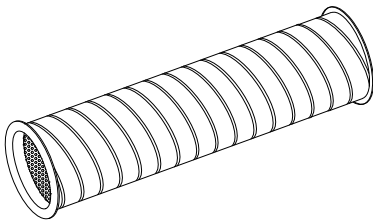

**DW6101 SPIRAL PIPE**  
 6" - 46" Diameter (I.D.)  
 8 ft. Jts. Standard

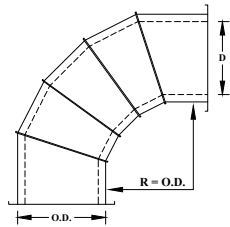

**DW6111 90° ELBOW**  
 5 Piece Gorelock

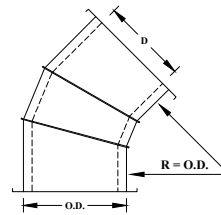

**DW6121 45° ELBOW**  
 3 Piece Gorelock

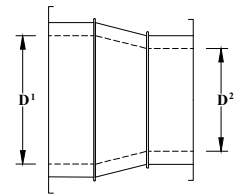

**DW6265 REDUCER**

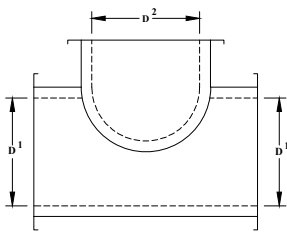

**DW6271 90° TEE**

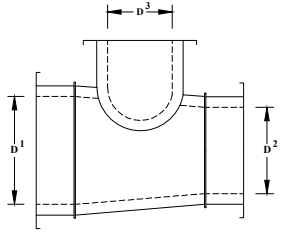

**DW6271R REDUCING 90° TEE**

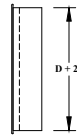

**DW6273 END CAP**

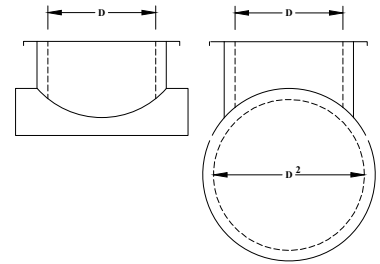

**DW6307 SADDLE TAP**

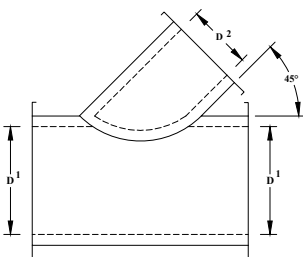

**DW6276 45° LATERAL**

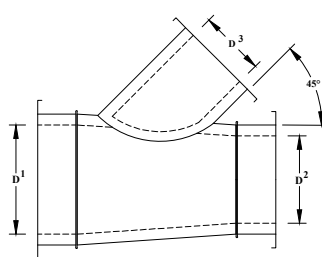

**DW6276R REDUCING 45° LATERAL**

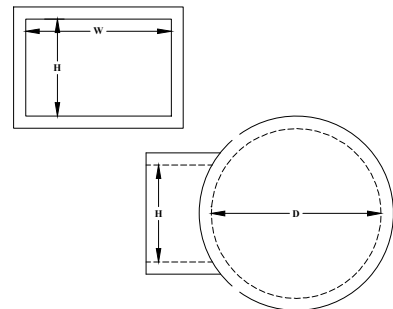

**DW6406 GRILLE TAP**

CONTACT OUR COMMERCIAL DUCT DIVISION (800-818-7144)  
 FOR SPECIFICATIONS, PRICING AND AVAILABILITY.

## UNIVERSAL ACCESS DOOR

- 👑 For Sheet Metal Duct or 1" and 1 ½" Duct Board
- 👑 Door Construction: 24 Gauge Galvanized Steel  
Dovetails are 26 Gauge Galvanized Steel
- 👑 Door Sizes 6" x 6" through 16" x 16" Provided with 2 Cam Locks
- 👑 Larger Sizes Provided with 4 Cam Locks

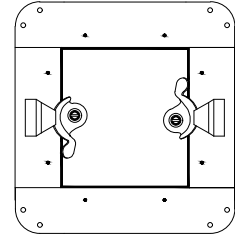

**450 ACCESS DOOR**

## ACCESS DOOR

- 👑 Available Sizes: 6" x 6" - 24" x 24"
- 👑 Removable 24 Gauge Insulated Double Panel Door, 24 Gauge Frame
- 👑 Dual Cam Locks (4 Cam Locks on sizes 16" x 16" & larger)
- 👑 1" Thick Insulation in Door Panel
- 👑 ½" Wide, ⅛" Thick Dual Gasket (Door to Frame / Frame to Duct)

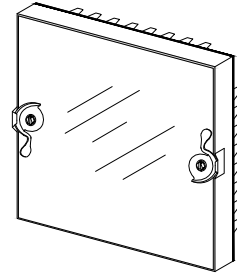

**451 ACCESS DOOR**

## ACCESS DOOR FOR ROUND PIPE

- 👑 1" Flange Contoured to fit Round Sheet Metal Duct
- 👑 Construction: 24 Gauge Galvanized Steel Door  
26 Gauge Galvanized Steel Body
- 👑 Door Sizes 6" x 6" through 16" x 16" Provided with 2 Cam Locks,  
Larger Sizes Provided with 4 Cam Locks
- 👑 Gasket on Door Ensures Air Tight Seal

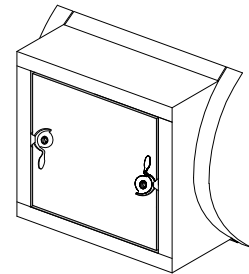

**450-R ACCESS DOOR**

## ACCESS DOORS WITH HINGE

- 👑 For Sheet Metal Duct or 1" and 1 ½" Duct Board
- 👑 Door Construction: 24 Gauge Galvanized Steel  
Dovetails are 26 Gauge Galvanized Steel
- 👑 Hinged Door with Cam Lock
- 👑 Door Sizes Available: 6" x 6" through 24" x 24"

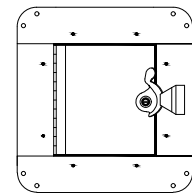

**450-H ACCESS DOOR**

- 👑 Door Sizes Available: 6" x 6" through 24" x 24"
- 👑 24 Gauge Insulated Double Panel Door, 24 Gauge Frame
- 👑 Hinged Door with Cam Lock
- 👑 1" Thick Insulation in Door Panel
- 👑 ½" Wide, ⅛" Thick Dual Gasket (Door to Frame / Frame to Duct)

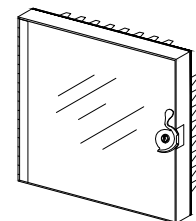

**451-H ACCESS DOOR**

## DAMPER SLEEVES

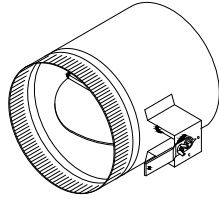

**175-XS1 DAMPER SLEEVE**  
 2" DAMPER HANDLE  
 STANDOFF  
 (SIZES 4" - 12")

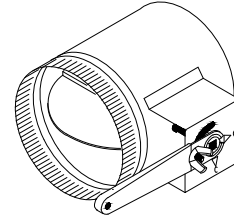



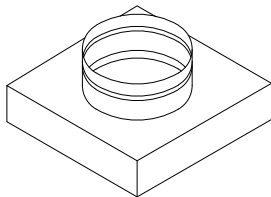

**175-XS2 DAMPER SLEEVE**  
 with  $\frac{3}{8}$ " SOLID ROD AXIS  
 & 2" STANDOFF  
 (4" - 20")

## ADAPTERS





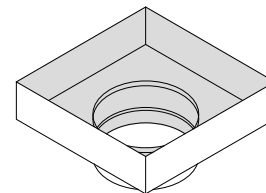

**666 ADAPTER**

-  Rectangular dimension made  $\frac{3}{16}$ " oversize  
 Round Collar dimension made  $\frac{1}{8}$ " undersize
-  Sizes 4" x 4" thru 24" x 24" - 28 gauge  
 Sizes 26" x 26" thru 30" x 30" - 26 gauge
-  3" Deep Rectangular End  
 3" Long Round Collar
-  Oval collars also available







**666-B ADAPTER**  
**BLACK INTERIOR**





-  Rectangular dimension made  $\frac{1}{4}$ " oversize  
 Round Collar dimension made  $\frac{1}{4}$ " undersize
-  All sizes 26 gauge
-  2  $\frac{7}{8}$ " Deep Rectangular End  
 2  $\frac{3}{4}$ " Long Round Collar
-  Black Interior

## NOTES AND FIGURES

# COMMERCIAL TAKEOFF FITTINGS

## 3000 Series Takeoff Fittings for Commercial Duct Installation.

-  Made to meet SMACNA gauge standards. Maximum 2" w.g. Positive Static Pressure. (SMACNA HVAC Duct Construction Standards Metal and Flexible - 2nd Edition 1995)
-  Fabricated with continuous weld longitudinal seam for no air leakage at 2" w.g. static pressure. Eliminates air leaks caused by riveted or spot welded seams.
-  Easy to install, features designed to reduce job installation costs.
-  Specifications:
 

Collar Diameter	Galvanized Steel Gauge
4" through 8"	28 gauge
9" through 14"	26 gauge
16" through 20"	24 gauge
-  Collar length is 5 ½" - all sizes.
-  **"D"** suffix designates fittings with reinforced axis manual volume damper.
  - Sizes 4" through 12" have reinforced damper axis with ¼" regulator.
  - Sizes 14" through 20" have ⅜" square continuous rod damper axis.
-  **"DS"** suffix designates fittings with 2" damper handle standoff for blanket insulation.
  - Sizes 4" through 12" have ¼" continuous rod damper axis, locking regulator and grommets installed at the collar penetrations.
  - Sizes 14" through 20" have ⅜" continuous rod damper axis, locking regulator and grommets installed at the collar penetrations.
-  **"DS2"** suffix designates fittings sized 4" through 12" with 2" damper handle standoff and ⅜" continuous rod damper axis, locking regulator and grommets installed at the collar penetrations.

## NOTES AND FIGURES

## CONICAL TAKEOFF

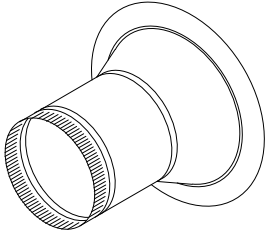

**3210 CONICAL**

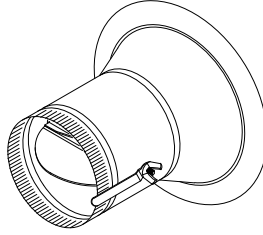

**3210-D CONICAL**  
with DAMPER

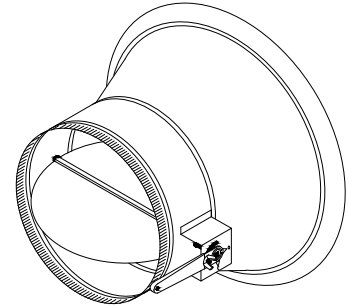

**3210-DS CONICAL**  
with  $\frac{3}{8}$ " SOLID ROD AXIS  
& 2" STANDOFF (14" - 20")

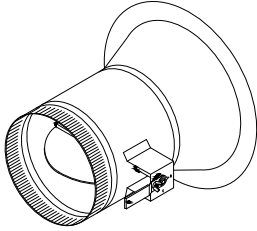

**3210-DS CONICAL**  
with 2" DAMPER HANDLE  
STANDOFF (4" - 12")

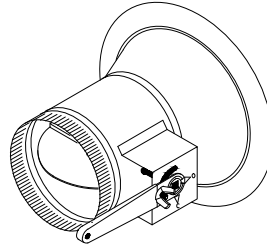

**3210-DS2 CONICAL**  
with  $\frac{3}{8}$ " SOLID ROD AXIS  
& 2" STANDOFF (4" - 12")

THE No. 3210 SERIES TAKEOFFS HAVE 1" WIDE GASKET ON THE OUTBOARD FLANGE.

## CONICAL SPIN-IN TAKEOFF

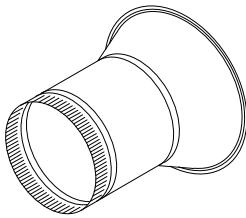

**3200 CONICAL SPIN-IN**

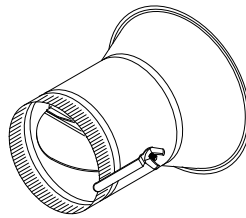

**3200-D CONICAL SPIN-IN**  
with DAMPER

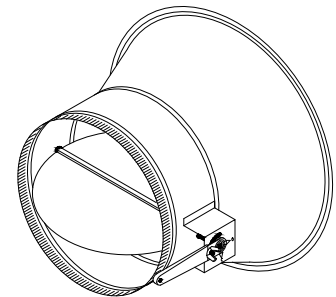

**3200-DS CONICAL SPIN-IN**  
with  $\frac{3}{8}$ " SOLID ROD AXIS  
& 2" STANDOFF (14" - 20")

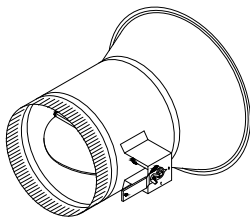

**3200-DS CONICAL SPIN-IN**  
with 2" DAMPER HANDLE  
STANDOFF (4" - 12")

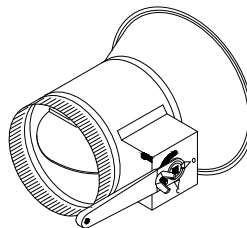

**3200-DS2 CONICAL SPIN-IN**  
with  $\frac{3}{8}$ " SOLID ROD AXIS  
& 2" STANDOFF (4" - 12")

# RECTANGULAR TO ROUND TAKEOFF

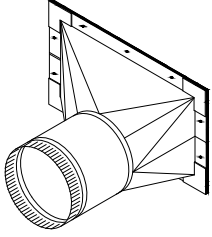

**3300 45° TAKEOFF**

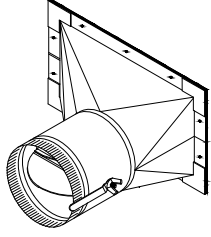

**3300-D 45° TAKEOFF**  
with DAMPER

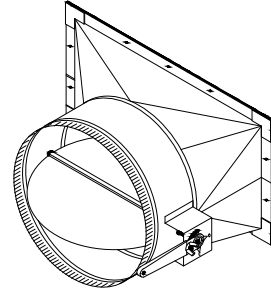

**3300-DS 45° TAKEOFF**  
with  $\frac{3}{8}$ " SOLID ROD AXIS  
& 2" STANDOFF (14" - 20")

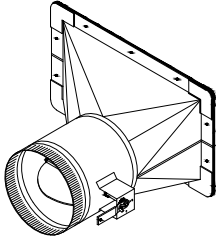

**3300-DS 45° TAKEOFF**  
with 2" DAMPER HANDLE  
STANDOFF (4" - 12")

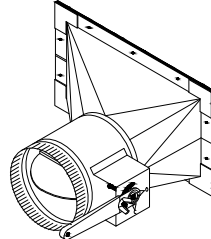

**3300-DS2 45° TAKEOFF**  
with  $\frac{3}{8}$ " SOLID ROD AXIS  
& 2" STANDOFF (4" - 12")

THE No. 3300 SERIES TAKEOFFS HAVE 1" WIDE GASKET ON THE RECTANGULAR OUTBOARD FLANGE.

# 45° TAKEOFF FOR ROUND PIPE

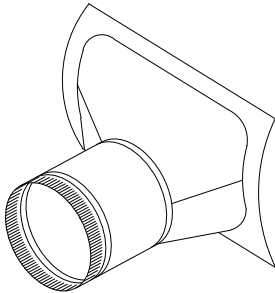

**3305 TAKEOFF**

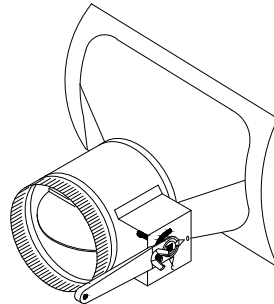

**3305-DS2 TAKEOFF**  
with  $\frac{3}{8}$ " SOLID ROD AXIS  
& 2" STANDOFF (6" - 12")

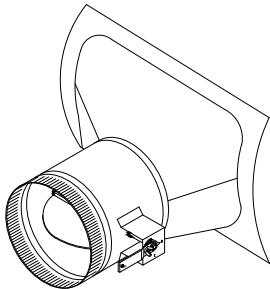

**3305-DS TAKEOFF**  
with 2" DAMPER HANDLE  
STANDOFF (6" - 12")

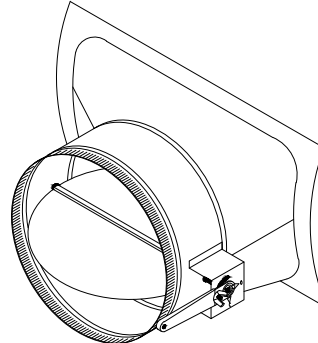

**3305-DS TAKEOFF**  
with  $\frac{3}{8}$ " SOLID ROD AXIS  
& 2" STANDOFF (14" - 20")

THE No. 3305 SERIES TAKEOFFS HAVE 1" WIDE GASKET ON THE RECTANGULAR OUTBOARD FLANGE.



# STRAIGHT TAKEOFF

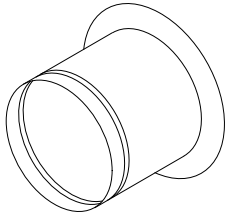

**3710 TAKEOFF**

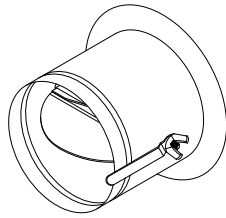

**3710-D TAKEOFF**  
with DAMPER

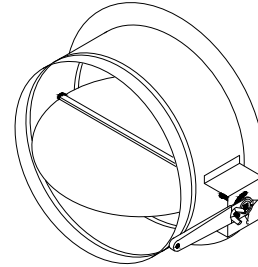

**3710-DS TAKEOFF**  
with  $\frac{3}{8}$ " SOLID ROD AXIS  
& 2" STANDOFF (14" - 20")

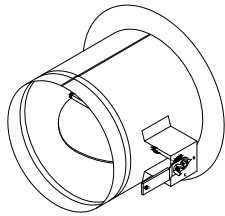

**3710-DS TAKEOFF**  
with 2" DAMPER HANDLE  
STANDOFF (4" - 12")

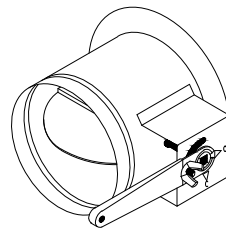

**3710-DS2 TAKEOFF**  
with  $\frac{3}{8}$ " SOLID ROD AXIS  
& 2" STANDOFF (4" - 12")

THE No. 3710 SERIES TAKEOFFS HAVE 1" WIDE GASKET ON THE OUTBOARD FLANGE.

# STRAIGHT SPIN-IN TAKEOFF

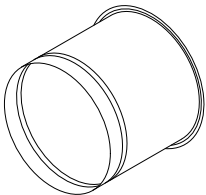

**3720 SPIN-IN TAKEOFF**

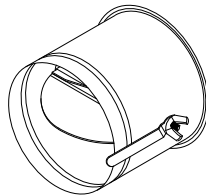

**3720-D SPIN-IN TAKEOFF**  
with DAMPER

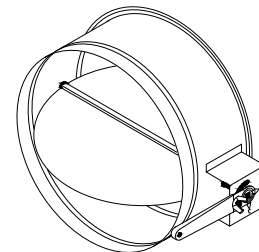

**3720-DS SPIN-IN TAKEOFF**  
with  $\frac{3}{8}$ " SOLID ROD AXIS  
& 2" STANDOFF (14" - 20")

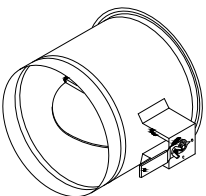

**3720-DS SPIN-IN TAKEOFF**  
with 2" DAMPER HANDLE  
STANDOFF (4" - 12")

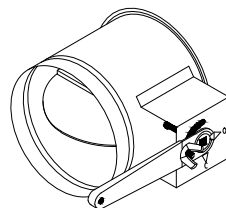

**3720-DS2 SPIN-IN TAKEOFF**  
with  $\frac{3}{8}$ " SOLID ROD AXIS  
& 2" STANDOFF (4" - 12")

**NUMERICAL INDEX**

<b>PART #</b>	<b>DESCRIPTION</b>	<b>PAGE</b>	<b>PART #</b>	<b>DESCRIPTION</b>	<b>PAGE</b>
88	Duct Board Box R-6	4	354	Plaster Frame	3
101 & 100	Snaplock Pipe & Rigid Vent Pipe	1	356	Plaster Frame with Boot	3
105	Flexell Pipe	1	357	Blind Box	3
107	Compressed Flexell Pipe	1	400 Series	S & D Rectangular Duct Work	20
111	Adjustable Elbow 90°	2	412-R	Round Flex Connector	15
121	Adjustable Angle 45°	2	450	Universal Access Door	26
175	Damper Sleeve	8	450-H	Access Door with Hinged Door	26
175-X	Damper Sleeve w/Stand-off	8	450-R	Access Door for Round Pipe	26
175-XS	Commercial Grade No. 175-X	27	451	Access Door	26
201	Wall Stack Duct	17	451-H	Access Door with Hinged Door	26
211	Wall Stack End Cap	17	461	Expand-O-Duct	14
222	Stackhead w/7" Throat	17	465	Expand-O-Duct	14
223	Stackhead w/12" Throat	17	469	Expand-O-Duct	14
230	90° Wall Stack L-W Elbow	17	480	Square-to-Round Transition	15
231	Wall Stack Straight Boot	17	490	4" Turning Vane	21
232	Range Hood Transition	17	492	4" Push-On Vane Rail	21
233	Wall Stack Angle Boot	17	496	2" Turning Vane	21
234	Wall Stack Center End Boot	17	498	2" Push-On Vane Rail	21
235	45° Wall Stack L-W Elbow	17	500	Adjustable Return Air Stand	12
236	Wall Stack Adj. Offset Boot	17	550	Condensing Unit Cover	14
240	90° Wall Stack S-W Elbow	17	554	4" Long Tie Down Bracket	12
241	Straight Register Boot	3	556 (-2)	6" Long Tie Down Bracket	12
242	Framed Register Boot	3	558	8" Long Tie Down Bracket	12
243	90° Angle Register Boot	3	560	Line Cover	14
243-F	Framed 90° Angle Register Boot	3	565	Line Cover with Cap	14
244	Center End Register Boot	3	600	Adjustable Return Air Stand	12
244-F	Framed Center End Boot	3	612	Can Stock	14
245	45° Wall Stack S-W Elbow	17	616 Series	Duct Board Tab Collar	8
246	Adjustable Register Boot	3	619	Inside Ring	8
261 Series	Start Collar - Metal Duct	7	620 Series	Duct Board Spin-Ins	8
265	Tapered Reducer	2	650 Series	Ring Seal Collars for Metal Duct	7
266	Flat Reducer	2	666	Square-to-Round Adapter	27
269	Register Box - Uninsulated	3	666-B	Adapter with Black Interior	27
271	Tee	2	667	Package Unit Adapters	13
273	End Cap for Round Pipe	14	680	Flex Duct Connector Sleeve	7
275	Manual Volume Damper	14	695	Saddle Hanger - Duct Board	16
276	In-line Wye	2	697	Duct Board Hanger Channel	16
277	Bull Nose Wye	2	700 Series	Dryer Box Items	11
278	One Way Adjustable Wye	2	710 Series	Gasket Flange Collars	9
279	Two Way Adjustable Wye	2	711 Series	Peel Off Gasket Flange Collars	9
301	Plenum	15	720 Series	Spin-Ins for Sheet Metal	7
301-CB	Plenum Unit Stand	12	750	Auxiliary Drain Pan	13
301-DB	Metal Framed Duct Board Stand	12	757	Auxiliary Drain Pan with Rails	13
301-R	Radius Back Plenum	13	777	1" x 100' Aluminum Strap	16
301-SM	Plenum Unit Stand	12	778	1" x 200' Aluminum Strap	16
305	Round Take-Off	3	792	Tying Wire	16
306	Adjustable Take-Off	3	793	90° Angle 10 Ft. Long	16
309	Side Take-Off	3	795	Hanger Strap 10 Ft. Long	16
310 Series	Take-Off with Gasket	10	797	1" x 100' Hanger Strap	16
311 Series	Take-Off with Peel-off Paper	10	798	1.5" x 100' Hanger Strap	16
332	Vent Top with Wind Band	17	799	2" x 100' Hanger Strap	16
334	Vent Top	17	800 Series	TDF Rectangular Duct Work	20
336	Roof Flashing	17	900	Return Air Box 6" Deep	18
339	Storm Collar	17	905	Return Air Box 10" Deep	18
341	Roof Jack for Flat Roof	17	920	Supply Connector	18
341-P	Roof Jack for Pitched Roof	17	925	Supply Bushing	18
349 Series	Side Wall Vent	11	935	Back Draft Damper 4" Deep	18
350 Series	Roof Cap	11	945	1" Disposable Air Filter	18
353	Refrigerant Line Roof Jack	17	950	Floor Grille	18

**NUMERICAL INDEX**

<b>PART #</b>	<b>DESCRIPTION</b>	<b>PAGE</b>	<b>PART #</b>	<b>DESCRIPTION</b>	<b>PAGE</b>
965	Wye	18	1520	2" Standing Barlock 20 Ga.	25
971	Single Wide Duct Kit	18	1522	2" Standing Barlock 22 Ga.	25
972	Single Wide Duct Kit	18	1524	2" Standing Barlock 24 Ga.	25
974	Double Wide Duct Kit	18	1565-CRD	Ceiling Radiation Damper Box	6
976	Double Wide Duct Kit	18	1575-CRD	Ceiling Radiation Damper Box	6
1024	Flat S-lock 24 Gauge	21	1575	Insulated Register Box R-6.0	4
1026	Flat S-lock 26 Gauge	21	1575-G	Ins. Reg. Box w/Gasket R-6.0	5
1028	Flat S-lock 28 Gauge	21	1580	Insulated Register Box R-6.0	4
1124	1" Standing S-lock 24 Gauge	21	1580-G	Ins. Reg. Box w/Gasket R-6.0	5
1126	1" Standing S-lock 26 Gauge	21	1592-CRD	DB Box w/ Ceiling Rad. Damper	6
1224	Flat Drive 24 Gauge	21	1620	Standing Drive Cleat 20 Gauge	25
1226	Flat Drive 26 Gauge	21	1622	Standing Drive Cleat 22 Gauge	25
1228	Flat Drive 28 Gauge	21	1624	Standing Drive Cleat 24 Gauge	25
1242	Insulated Tapered Boot R-4.2	4	1780	Insulated Register Box R-8.0	5
1242-FL	Insulated Tapered Boot R-6.0	4	1788	DB Reg. Box R-8.0	5
1243-FL	R-6 Floor Boot	4	1792	DB Register Box R-8.0	5
1244-FL	R-6 Floor Boot	4	1798	DB Box w/Slanted Top R-8.0	5
1250	Mounting Bracket 24 Gauge	16	2001	Slot Diffuser Plenum	21
1250-16	Mounting Bracket 16" long	16	3200 Series	Commercial Conical Spin-Ins	29
1252	Mounting Bracket 26 Gauge	16	3210 Series	Conical Take-Offs w/Gasket	29
1254	Mounting Bracket Screw on	16	3300 Series	45° Take-Offs	30
1260	Mounting Angle	6	3305 Series	45° Take-Offs for Round Pipe	30
1269	Insulated Register Box R-4.2	4	3710 Series	Take-Offs w/Gasketed Ring	31
1269-FL	Insulated Register Box R-6.0	4	3720 Series	Spin-Ins	31
1275	Insulated Register Box R-4.2	4	FHE	Filter Housings	14
1284	DB Reg. Box w/o Flange R-4.2	4	PL 4	4" long Plenum Legs	13
1288	DB Reg. Box w/Flange R-4.2	4	PR	Passive Return Sleeves	16
1288-FL	DB Reg. Box w/Flange R-6.0	5	RAP	Return Air Pathway Kit	16
1288-FLG	R-6 DB Box with Gasket	5	RETRO RAP	Return Air Pathway Kit	16
1292	DB Register Box 11" High R-4.2	4	RED-1	R-6 Small Reducer D.B. Box	13
1292-CRD	DB Box w/ Ceiling Rad. Damper	6	RED-2	R-6 Large Reducer D.B. Box	13
1292-FL	DB Register Box 11" High	5	RED-3	R-6 X-Large Reducer D.B. Box	13
1292-FLG	R-6 DB Box with Gasket	5	RED-4	R-6 Jumbo Reducer D.B. Box	13
1293	R-4.2 Slant Top Box with Collar	4	SK	Silent Knight Return Air Sleeve	16
1293-FL	R-6 Slant Top Box with Collar	4	TRI-S	R-6 Small Triangle D.B. Box	13
1298	DB Box w/Slanted Top R-4.2	4	TRI-M	R-6 Medium Triangle D.B. Box	13
1298-FL	DB Box w/Slanted Top R-6.0	5	TRI-L	R-6 Large Triangle D.B. Box	13
1298-FLG	R-6 DB Box with Gasket	5	TRI-XL	R-6 X-Large Triangle D.B. Box	13
1320	1" Standing Bar Lock 20 Ga.	21		Single Wall Galv. Spiral Duct	22
1322	1" Standing Bar Lock 22 Ga.	21		Single Wall Paint-grip Spiral Duct	22
1324	1" Standing Bar Lock 24 Ga.	21		Single Wall Fitts w/EDGE® Gasket	23
1420	1 ½" Standing Barlock 20 Ga.	21		Single Wall Flat Oval Spiral Duct	24
1422	1 ½" Standing Barlock 22 Ga.	21		Double Wall Galv. Spiral Duct	25
1424	1 ½" Standing Barlock 24 Ga.	21		Double Wall Paint-grip Spiral Duct	25
1480	Square-to-Round Trans R-4.2	15			
1480-FL	Square-to-Round Trans R-6.0	15			

**NOTES AND FIGURES**

Distributed By



**Corporate Office**

6390 Philips Highway  
Jacksonville, FL 32216  
(904) 737-7144  
(800) 683-7144  
(904) 737-3533 fax

**Commercial Duct Division**

3545 New Kings Road  
Jacksonville, FL 32209  
(904) 924-8340  
(800) 818-7144  
(904) 924-0841 fax

[www.crownproductsc.com](http://www.crownproductsc.com)