



DUST FREE[®]

BREATHE THE DIFFERENCE[®]

Shaping the future of IAQ technology.

Explore the products that are driving indoor air quality innovation.

See how millions of ions can clean the air.

Page 4

Clean air is priceless.

- Gregg Burnett, CEO

Founded in 1982, Dust Free® is a family-owned business working toward cleaner indoor air environments, for today, and for the future.

The Dust Free® journey began in 1979 after a tragic mechanical failure in the HVAC system of the Burnett family home resulted in long-lasting health issues and an acute sensitivity to airborne pollutants. Through their determination to regain the health of their family, and a lack of commercially available solutions, the Burnetts developed an innovative electrostatic air filter for their home and saw major improvements in their well-being. With improving health and strength, Dust Free® was born and their mission was clear... share the freedom of clean air with the world.

While continuing to manufacture thousands of electrostatic filters each year, technology and company focus has expanded to providing a wide range of premium, lab-tested products to homeowners, contractors, and market-leading HVAC OEMs alike.

Today, Dust Free® continues to pursue its passion for indoor air quality by developing and manufacturing robust, market-leading products that reduce airborne contaminants, improve HVAC system lifespan, and reduce energy consumption. Whether it's a contractor-friendly HVAC accessory, a custom engineered filtration solution, or a stage gate driven development project, rest assured that you will Breathe The Difference with Dust Free®.

Clean air is our passion.

We are a forward-thinking company, filled with talented individuals who are passionate about clean air, indoor air quality, and the environment.

Dust Free® manufactures a family of IAQ products designed to work together to provide a complete air quality management strategy.

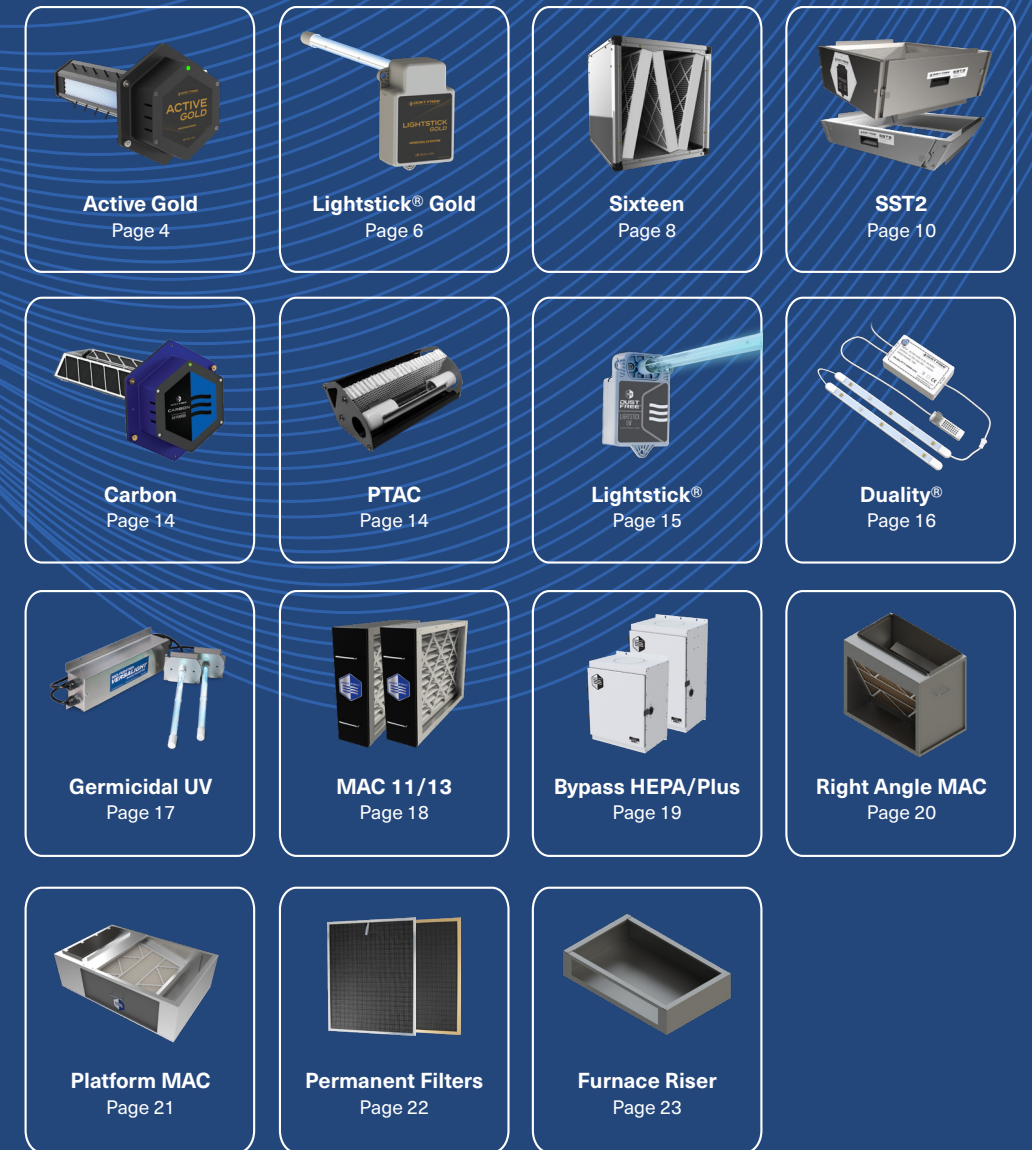

The new Active Gold. 20% more ion production.

Still zero ozone production.

Carbon Fiber Ionizers.

Millions of negatively-charged ions make virus-carrying dust particles clump together and settle out of the air or become large enough to filter.

Germicidal UV Lamp.

UV-C spectrum germicidal light is a powerful tool for microbial inactivation and HVAC disinfection.

Active Photocatalysts.

UV-activated catalysts for breaking down organic pollutants and odors.

RESIDENTIAL AND COMMERCIAL APPLICATIONS

Active Gold

Utilizes a dynamic mix of UV light, carbon fiber ionizers, and active photocatalysts to make our most capable IAQ device ever.

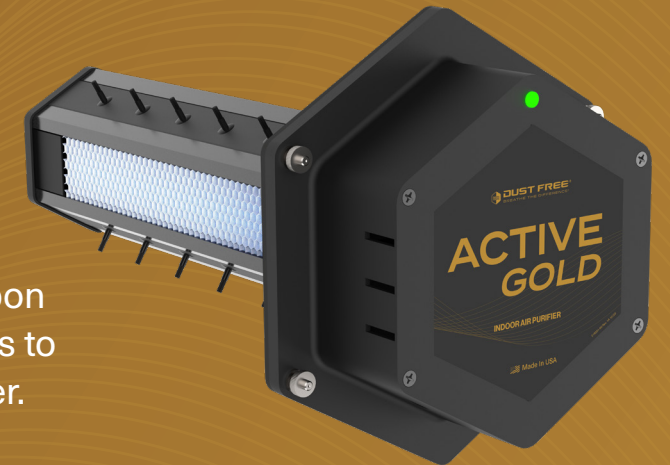

 Meets UL 2998 no ozone standards and is CARB certified.

The Ultimate IAQ Solution

The Active Gold offers airborne particulate control, UV disinfection and odor neutralization in a single unit. Carbon fiber ionizers, robust engineering, and corrosion-resistant materials, make this our highest performing, most dependable, and safest IAQ device ever.

Twist-Lock Power Cord.

Ensures a secure power connection even through vibrations and movements.

Custom Power Supply.

Purpose built for coast-to-coast protection in high humidity, high salt, and high temperature HVAC environments.

Increased Ion Production.

Redesigned ionizers produce more negatively-charged ions and increase ion density.

Reliable Performance.

3000V surge protection and gentle lamp start feature ensure extended durability and prolonged usage.

Mounting Plate.

Gasket-sealed mounting plate for easy installation and service in metal or fiberglass ductwork.

Tech Friendly.

UL, CE, and FCC compliant PCB, to ensure safety and compatibility with your home.

24V Auxiliary Power Port.

Add a Lightstick[®] Gold for HVAC coil disinfection.

Safety.

Power interlock switch keeps operators safe during lamp maintenance.

The new Lightstick[®] Gold. Category-Defining Germicidal UV.



Demand more from your UV-C platform.

- New cord design allows access panel interlocking and meets UL60335-2-40 safety standards. (Magnetic safety interlock included.)
- FCC Part 15B EMI compliance ensures stable performance without interference and potential disruptions. Perfect for tech friendly homes with electronic devices like WiFi.
- Revolutionary thermal protection with improved heat resistance and thermal auto-restart for reliability in the hottest attics.
- 3000V surge protection and wide voltage range ensures consistent and stable UV operation.
- Pre-heated UV lamp reaches optimum UV light emissions faster and extends lamp service life.
- Sine wave current input with Power Factor Correction (PFC) technology to maximize electrical efficiency and reduce load on transformers.

GERMICIDAL UV

Lightstick[®] Gold

The new standard for microbial inactivation and HVAC surface disinfection.

- Meets UL 2998 no ozone standards.
- Meets California ozone emissions limit: CARB certified.
- Meets UL60335-2-40 standards.
- Meets FCC Part 15B EMI compliance.
- Meets UL 1598 - 5th ed. standards.



Maximum UV Performance and Safety

The Lightstick[®] Gold employs our most advanced technologies to deliver optimized germicidal UV performance, while also ensuring maximum safety compliance with unmatched operational stability.

New Cord Design.

Separate cords for power and safety interlock allows integration with access panels for improved safety during maintenance.

Ozone Free and Safety Compliant.

Not only ozone free, but one of the most heavily compliant UV systems available.

Lamp Failure Indicator.

Built-in lamp failure indicator circuitry allows for proactive maintenance by detecting a failed lamp.

Dual Install Options.

Detachable lamp design for optimum UV exposure in direct connect or remote mount configurations.

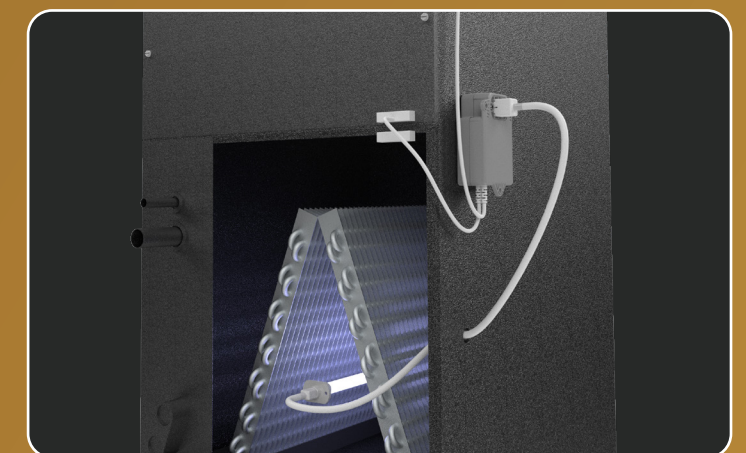

Includes all necessary safety accessories, including magnetic safety interlock, to meet the new UL60335-2-40 standards.

The new Sixteen. Peak airflow.

Premium high MERV filtration that meets restrictive SEER 2 requirements.

The 2.5" thick, glue bead, mini pleat filter combined with optimized pleat geometry and a huge surface area of up to 280 ft², allows for a MERV 16 filtration system with the flow resistance of a typical MERV 8 filter.

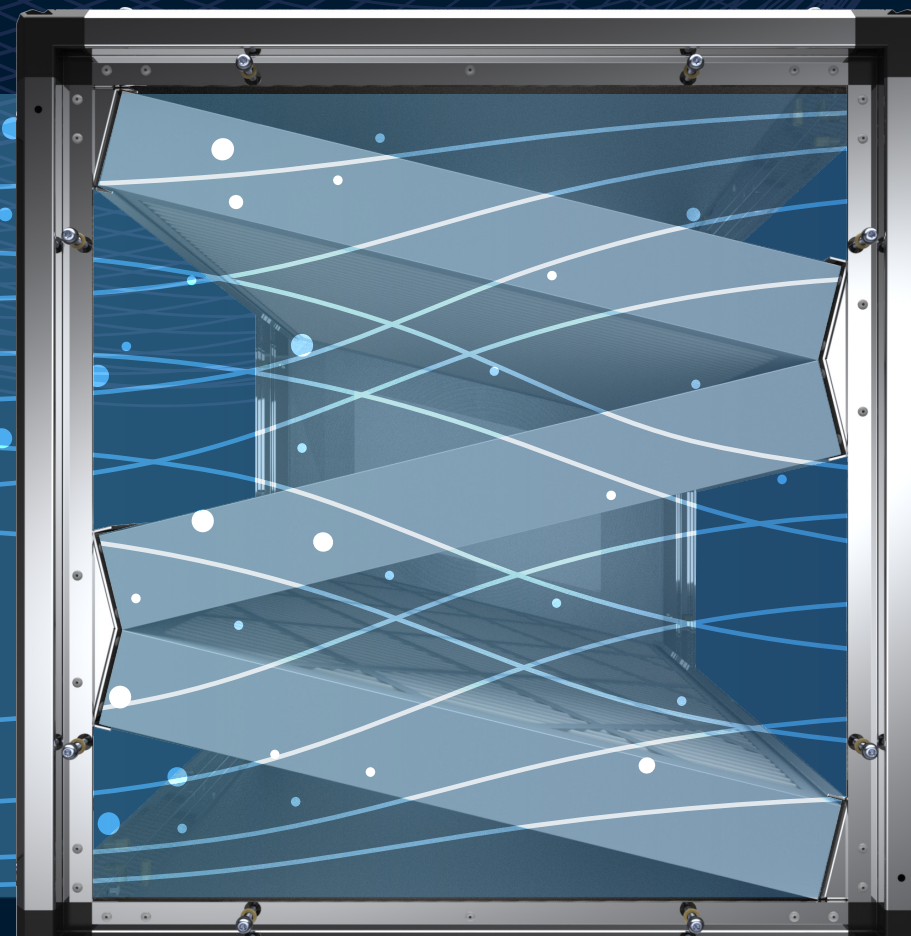

MEDIA AIR CLEANER

Sixteen

Whole home filtration with best in class airflow, filter life, and space-saving design.

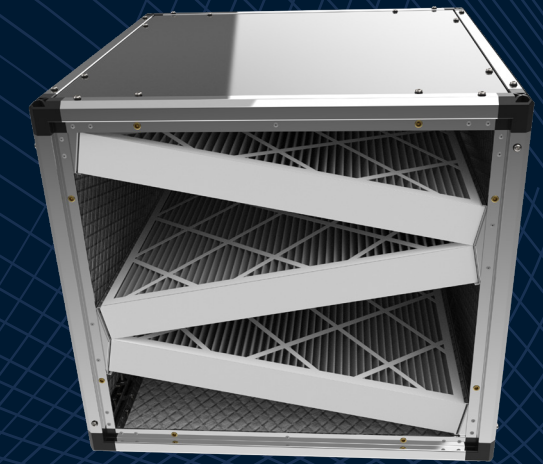

Initial Resistance	3-Ton Model	5-Ton Model
	0.13" H ₂ O @ 1200 CFM.	0.18" H ₂ O @ 2000 CFM.

The Peak of MERV 16 Filtration

The Dust Free[®] Sixteen is a high-efficiency, low-resistance MERV 16 media air cleaner with a remarkable filter life of up to three years. Multiple pleated media filters arranged in an optimized airflow geometry provide up to a whopping 280 ft² of long-lasting media surface area with a pressure drop that rivals significantly less efficient MERV 8 filters.

High Efficiency.

Superior in capturing household allergens, as well as fine smoke particles and bacteria as small as 0.3 microns.

Multi-Year Filter Life.

A huge pleated media surface area with high dust holding capacity delivers a long-lasting filter life of up to 3 years.

Low Resistance.

Best performing pressure drop for lower energy consumption, and longer equipment life. SEER 2 compliant.

Built To Outlast HVAC Systems.

Constructed of corrosion-resistant materials, 6063-T6 aluminum cabinet, ABS plastic frame corners, and aluminum filter rails.

Space-Saving Design.

Ships in a partially assembled, knock-down format for easy carry and field assembles in minutes.

Less Maintenance.

Extended filter life means longer interval between replacement filter maintenance service.

Multiple Applications.

Seamlessly integrates into the return air flow stream of upflow, horizontal, attic, and basement HVAC systems.

The SST2. More than a transition.

The future of HVAC maintenance and servicing.

Extra-large service door opening saves time on routine visits and service maintenance agreements.

100% airflow transition for optimized SEER performance.

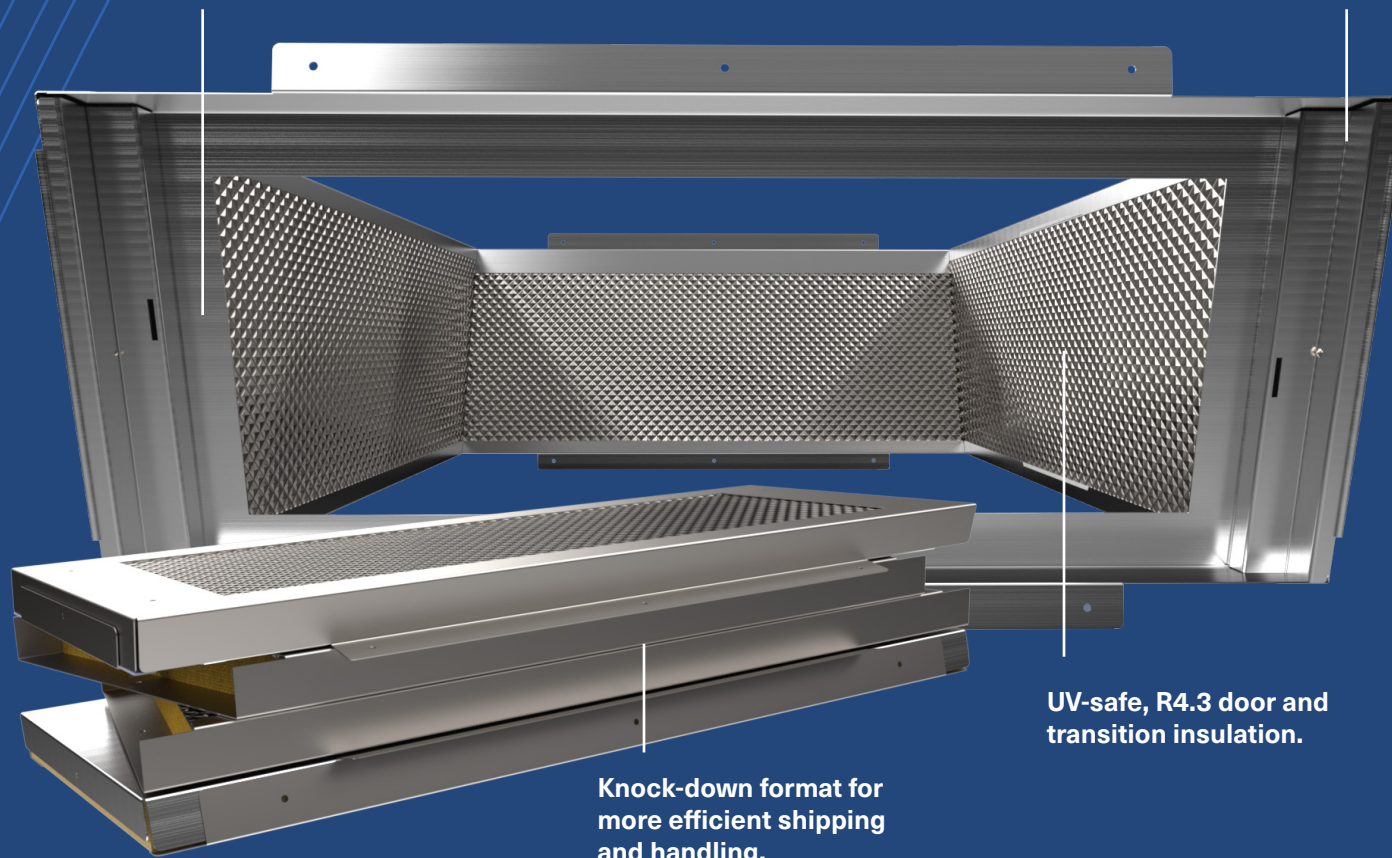

Knock-down format for more efficient shipping and handling.

UV-safe, R4.3 door and transition insulation.

SYSTEM SERVICE TRANSITION

SST2

The SST2™ system service transition allows for quick and efficient HVAC system service while providing optimal SEER performance with 100% airflow.



Side Access Series and Closet Series.

Optimized SEER Performance + Easy Service

The industry's only compact, knock-down, system transition with a true access door, large enough to allow for proper inspections and maintenance, without dismantling the system. Meets 2023 SEER standards and is pre-fabricated for use with a variety of Dust Free[®] IAQ products.

Optimized SEER Performance.

The SST2 improves air flow distribution without block-offs or restrictions. Compatible with 2023 SEER2 standards.

Extra-Large Door.

True access to coil/ heat exchanger for inspections, cleaning, leak detection, heat exchanger inspection, and system checks.

Fully Insulated Door.

Door and panels come lined with foil-backed, UV-safe, R4.3 insulation. Meets standards and code compliance for HVAC accessories.

Multiple Applications.

Available in Side Access Series and Closet Series for upflow, horizontal, attic, closet, and basement applications.



The SST2 installs between the furnace and the coil to provide more efficient airflow between different-sized components.

These products are your first line of defense when smoke is causing air quality issues.

Unfortunately, as wildfires become more normal in our daily lives, we are forced to deal with poor air quality outdoors as well as indoors.

Did you know that poor outdoor air quality can cause the air inside your home to be unhealthy to breathe?

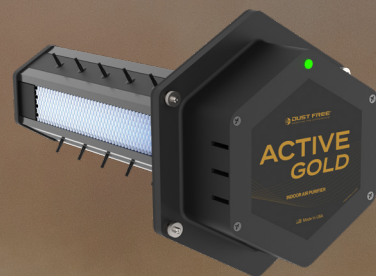

Active Gold
Page 4



Bypass HEPA
Page 19



Bypass HEPA Plus
Page 19

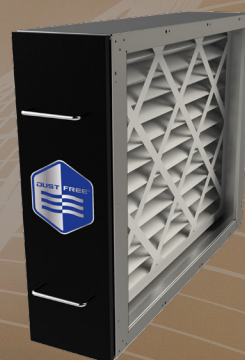

MAC 11
Page 18



MAC 13
Page 18

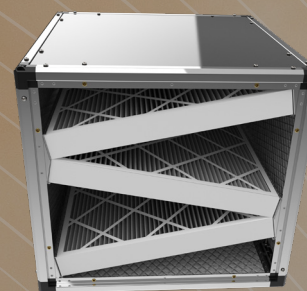

Sixteen
Page 8

RESIDENTIAL AND COMMERCIAL APPLICATIONS

Carbon

The Dust Free[®] Carbon improves indoor air with a unique Carbon/UV Light technology that specifically targets Formaldehyde and uses UV energy to shine in the interior surfaces of the HVAC system.

 Meets UL 2998 no ozone standards and is CARB certified.

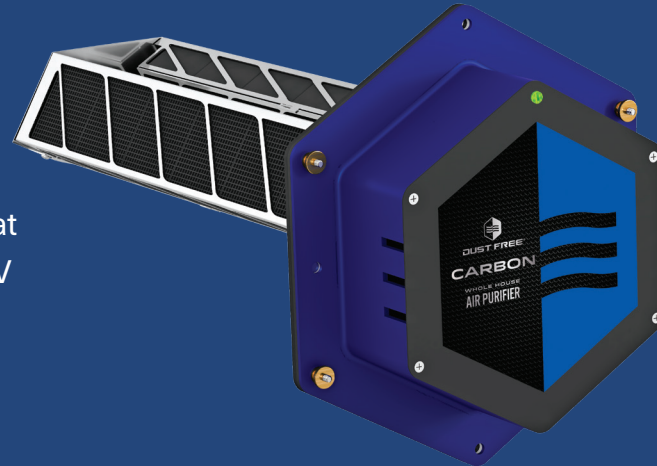

- **Formaldehyde.** Proprietary Carbon/UV-C Light multi-stage technology effective at reducing Formaldehyde.
- **Ozone Free.** Meets and surpasses UL 2998 no ozone standards. CARB certified.
- **High Performance.** 2.5X more effective at removing Formaldehyde than the nearest competitor.
- **Reliability.** Expanded range (20V-32V) ballast and 3000V surge protection for increased electrical reliability.
- **Laboratory Tested.** Laboratory tested and effective against Formaldehyde.
- **IAQ Expandable.** Includes an auxiliary power port to easily install an additional 24V germicidal UV-C light to any HVAC system.

HOSPITALITY APPLICATIONS

PTAC

The Dust Free[®] PTAC Air Purifier brings advanced air purification technology to PTAC/ETAC, ductless mini-split, and other space limited HVAC applications.

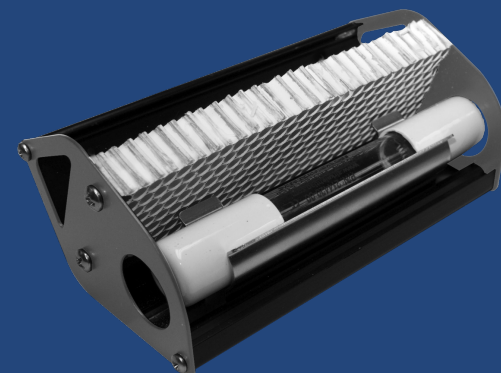

GERMICIDAL UV

Lightstick[®]

Engineered to dose interior HVAC surfaces where the light shines.

 Meets UL 2998 no ozone standards and is CARB certified.

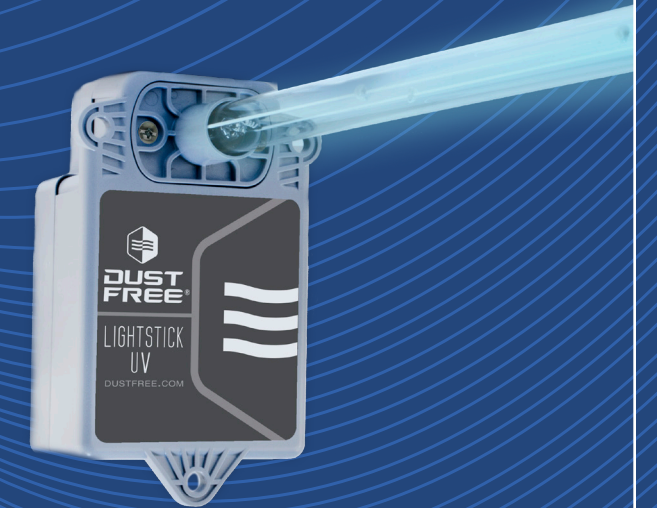

High-Output Germicidal UV

The Lightstick[®] is a development collaboration between Dust Free[®] and the leading UV lamp manufacturer in Europe. When properly installed in the HVAC system, the improved germicidal UV-C output of the Lightstick[®] models to reduce specific targeted bacteria, mold, and viruses where the light shines.

- **Ozone Free.** Meets and surpasses UL 2998 no ozone standards. CARB certified.
- **Low Mercury.** Uses low mercury lamps that are better for the environment and provide high ambient temperature operation.
- **Power Stability.** Expanded range ballast operates over a range of 20V to 32V and offers 3000V surge protection.
- **Durability.** Highest quality components engineered for the toughest HVAC environments.
- **Direct Connect.** Custom design allows lamp to be installed directly in A-coil delta plate for optimal UV exposure.
- **Remote Mount.** Custom bracket offers remote mount capability.
- **Easy Maintenance.** Quick disconnect lamp connection enables easy lamp replacement.
- **Highly Accelerated Life Testing.** Comprehensive HALT testing for improved reliability.

FOR DUCTLESS OR MINI-SPLIT SYSTEMS

Duality®

The Dust Free® Duality® is the highest quality UV light designed for confined spaces such as ductless or mini-split systems.

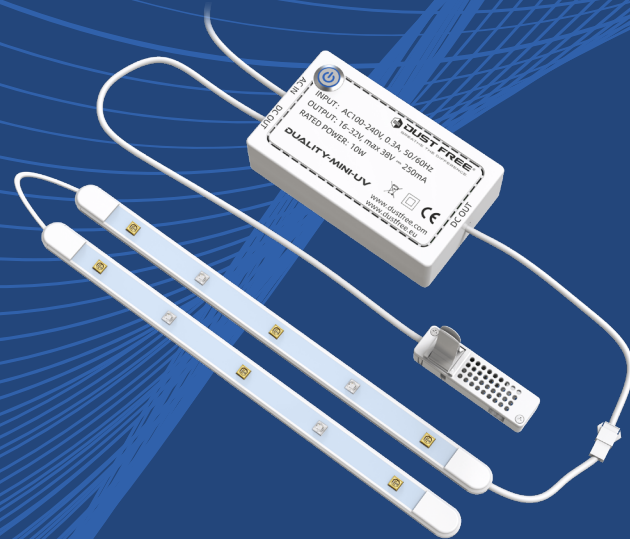

The Solution For Mini-Split Systems

The Dust Free® Duality® is mini in size, and huge in capability. Dual-spectrum UV maximize sanitized surface areas. While dual UV LED arrays, plus VOC filter, double the sanitizing options. The Dust Free® Duality® UV is designed to fit and function in compact areas of HVAC components. Germicidal ultraviolet (UVGI) helps inactivate viruses and bacteria¹ on damp surfaces ensuring the optimal efficiency of your system.

- **Dual UV LED Arrays.** Dual, mercury free, UV LED arrays maximize UV surface exposure.
- **Dual UV Spectrums.** UV-A and UV-C irradiation.
- **Dual Voltage.** Dual input voltage, 120VAC or 230VAC.
- **Dual Options.** Dual sanitizing options, VOC filter and UV coil scrubbing.
- **Ozone Free.** Zero ozone emissions.
- **Air Sensing.** Easy clip-on airflow sensor automatically and proactively powers unit on/off.
- **Tested and Qualified.** Electromagnetic Compatibility(EMC) and Low Voltage Directive(LVD) tested and qualified safe for indoor applications.
- **Easy Installation.** Easy installation and low maintenance.



Ultra-Flex

The Ultra-Flex offers more value and choice than ever before. Offering compact size and remote-lamp capability, the Ultra-Flex provides a first-class UV system for even the tightest spaces.

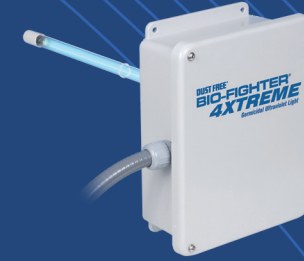

4Xtreme

The 4Xtreme rooftop UV-C fixture, equipped with a UL listed NEMA 4X interlocked enclosure, can handle the harshest of HVAC environments.



VersaLight

The VersaLight utilizes patent pending, safety interlocked, remote-mounted lamp capability that allows placement of one, or two, high-output UV-C lamps anywhere within 6 feet of the VersaLight's chassis.

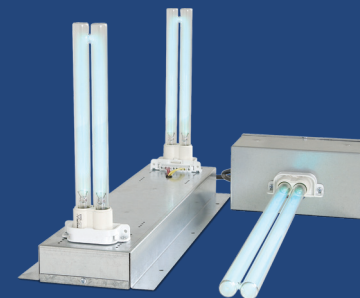

Nomad & Nomad 2

Surface mounted UV-C applications demand installation flexibility and the Nomad delivers one of the most flexible chassis designs available.



XL

XL is uniquely qualified for extra large applications with lamp lengths up to five feet and a class leading reflector surface area to cost effectively apply a high dose of UV-C energy. Magnetic mounting brackets simplify installation.

MEDIA AIR CLEANER

MAC 13
MAC 11

MERV-rated filter technology to capture a significant amount of airborne particles, including sub-micron particles.



MAC 11

MAC 13

Best Balance of Filtration and Air Flow

The Dust Free[®] Media Air Cleaners utilize best in class filters, up to MERV 13, with increased filtration surface that reduces air flow restriction, leading to reduced HVAC equipment lifespan, higher energy consumption, and poor heating and cooling performance.

High Efficiency.

Up to MERV 13 performance captures dust, dander, smoke, pollen, and mold spores.

Sub-Micron Performance.

Filter technology captures fine particles missed by standard filters.

Low Resistance.

Lowest pressure drop MERV 13 filter at 0.24" w.c. (MAC 13)

High Capacity.

4" thick pleated media filter design for greater capacity than non-pleated filters.

Sealed Door.

Two-stage cabinet door seal and quadruple redundant strike and latch system minimizes air leakage.

Easy Maintenance.

Easy filter size identification and quick filter media replacement.

Durability.

Painted, 22ga., galvanized steel cabinet and door construction for lasting durability. (Unpainted cabinet on MAC 11.)

HEPA AIR CLEANER

Bypass HEPA/
Bypass HEPA Plus

Air cleaners with advanced filtration and purification features.

 Meets UL 2998 no ozone standards.



BYPASS HEPA

BYPASS HEPA PLUS

A Multi-Stage Solution for Improved Indoor Air Quality

The Dust Free[®] Bypass HEPA and Bypass HEPA Plus offer residential HEPA-grade filtration without added air resistance. The self-ventilated cabinet is prefabricated to quickly mount either directly to a return plenum, or through a remote collar configuration.

HEPA Efficiency.

HEPA filters capture 99.97% of airborne particles as small as 0.3 microns.

Multi-Stage Filtration.

Carbon, Merv 8, and HEPA. Also, germicidal UV-C and PCO filtration on Bypass HEPA Plus models.

Ozone Free.

Meets and surpasses UL 2998 no ozone standards.

Zero Added Static Pressure.

High-output fan delivers 400 CFM of HEPA-grade air for no added strain on the HVAC system.

Fully Insulated.

360° thermal insulation to maximize efficiency.

Installation.

Simplified installation with no added duct installs.

Mounting Options.

Remote collar or return duct mounting supports.

Safety.

Door safety interlock prevents unit operation when door is open.

NEW FOR 2024

Right Angle MAC

Provides a simple, combination duct transition and media air cleaner for vertical installation furnaces.



Benefits Your Whole House

The Dust Free[®] Right Angle Media Air Cleaner is the solution for media air cleaners that normally require a 90° transition to fit vertical furnace installations. The media air cleaner includes a MERV 11 filter that traps significantly more airborne particles than traditional disposable fiberglass filters.

High Efficiency.

MERV 11 performance captures dust, dander, smoke, pollen, and mold spores. MERV 13 filters available.

Spacing-Saving Design.

Integrated 90° duct transition. No separate transition required for vertical installations.

Adaptable Duct Inlet.

Includes adapter plate to fit different duct and equipment opening sizes to suit almost any application.

Reversible Door Design.

The filter access door is easily reversible to fit left-sided or right-sided return applications.

Improved Static Pressure.

Compatible with Dust Free[®] Furnace Riser for improved static pressure.

Construction.

High quality 22-gauge painted steel cabinet.

Easy Maintenance.

Easy filter size identification and quick filter media replacement.

NEW FOR 2024

Platform MAC

A two-in-one filtration and transition solution for space-constrained vertical up flow applications.

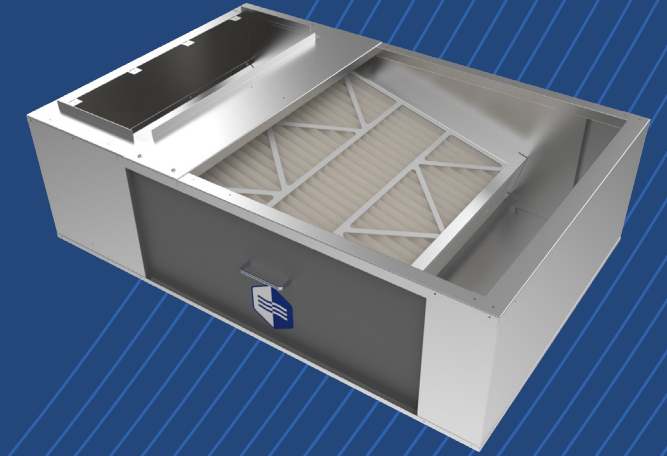

Filtration + Transition Solution

The Dust Free[®] Platform MAC provides a simple, space-saving, filtration and 90° transition to the furnace or air handler in vertical, bottom air-return installations. Saves both time and space for side drop and up flow applications that need air filtration.

High Efficiency.

MERV 11 performance captures dust, dander, smoke, pollen, and mold spores. MERV 13 filters available.

Space-Constrained Applications.

Space-saving 90° duct transition to the furnace or air handler in vertical, bottom air-return installations.

Adaptable Duct Inlet.

Includes adapter plate to fit different duct and equipment opening sizes to suit almost any application.

Reversible Door Design.

The filter access door is easily reversible to fit left-sided or right-sided return applications.

Saves Installation Time.

No separate transition installation is required.

Construction.

Sturdy 22-gauge painted steel cabinet and door.

Easy Maintenance.

Easy filter access simplifies maintenance.

Minimized Duct Leakage.

Sealed design and quality construction minimizes gaps and leaks.

PERMANENT AIR FILTERS

Permanent air filters offer a wise investment for protecting the home from everyday pollutants.

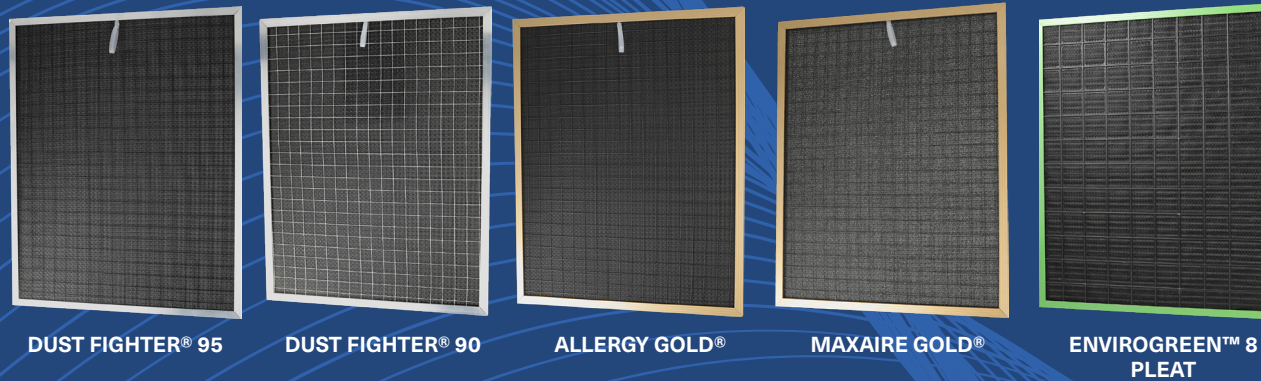

A Lifetime of Cleaner Air In Your Home

The Dust Free[®] permanent air filter uses self-charging electrostatic filtration media to reduce indoor air pollutants as the air circulates through the HVAC system. Regular cleaning with water and household detergent will keep them operating at peak efficiency for a lifetime.

- **Environmentally Friendly.** 100% washable and reusable. No more throwaway filters contributing to landfill.
- **Lifetime Warranty.** High-strength extruded aluminum frame and durable filtration media.
- **Designed For Convenience.** Integrated pull tabs for easy removal and drain holes for faster drying after cleaning.
- **Electrostatic Technology.** Multiple alternate polarity, self-charging layers of media
- **Made in the USA.** Manufactured with precise manufacturing techniques and attention to detail.
- **Easy To Clean.** Regular cleaning with water and household detergent will the air filter operating at peak efficiency.
- **Multiple Sizes.** Available in 40* standard sizes in 1" or 2" frames. Custom and adjustable sizes available.

*EnviroGreen 8 Pleat available in 33 standard sizes.

NEW FOR 2024

Furnace Riser

Helps increase the effective area of filtration by expanding the air inlet opening into the furnace.

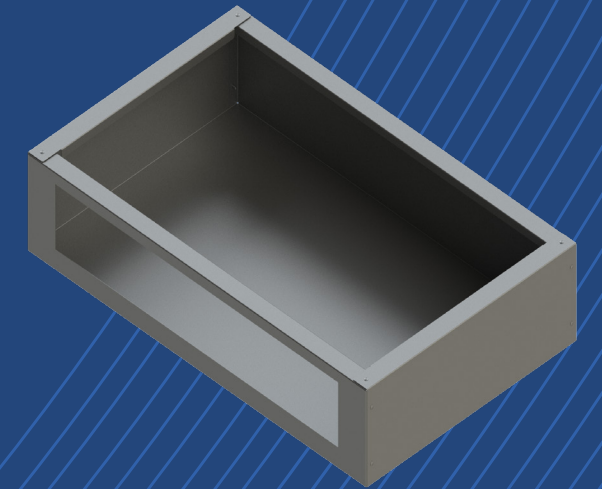

Maximizes Your Airflow

The Dust Free[®] Furnace Riser increases the total area of filtered airflow by lifting the furnace off the floor and allowing air to flow through both the bottom and side returns of the unit.

<p>Dual Returns. Lifts the furnace off the floor allowing airflow through both bottom and side returns.</p>	<p>MERV Expansion. Designed to accommodate larger filter cabinets and allow for higher MERV ratings without sacrificing flow resistance.</p>	<p>Airflow Volume. Increases the total area of filtered airflow into the system in vertical installations.</p>	<p>Pressure Drop. Helps reduce pressure drop in the system.</p>
<p>Construction. Sturdy 22-gauge painted steel construction to support the weight of the furnace and other accessories.</p>	<p>Match Fit. Available in four models to properly match furnace sizes.</p>		

AIR PURIFIERS

Active Gold
#13071

Sizes and Weight	Unit 8"H x 7"W x 9.5"L	Weight 3 lbs.
	Mounting Plate 8"H x 7"W	
Electrical	24VAC (Expanded range ballast: 20V-32V), 50/60Hz, 1.4A. 3000V surge protection.	
Ozone	UL 2998 validated no ozone. Meets California ozone emissions limit: CARB certified.	
Lamp	12", 18,000 hour lamp life.	
Lifespan	Core: 4 years. Lamp: 2 years.	
Warranty	7-yr power supply. 4-yr core. 2-yr lamp.	

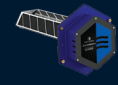
Carbon 14"
#13052

Sizes and Weight	Unit 8"H x 7"W x 16.5"L	Weight 3 lbs
	Mounting Plate 8"H x 7"W	
Electrical	24VAC (Expanded range ballast: 20V-32V), 50/60Hz, 1.4A. 3000V surge protection.	
Ozone	UL 2998 validated no ozone. Meets California ozone emissions limit: CARB certified.	
Lamp	Water-resistant, 18,000 hour lamp.	
Warranty	7-yr power supply. 2-yr lamp.	

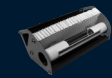

PTAC 230V
#10021-DF **PTAC 265V**
#10022-DF

Suitable for PTAC/ETAC models up to 500 CFM.

Size and Weight	Unit 2.25"H x 1.5"W x 5.9"L	Weight ~1 lb.
Electrical	230V and 265V options.	
Warranty	2-yr power supply. 2-yr core/lamp.	

HIGH EFFICIENCY AIR CLEANERS

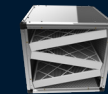
All air cleaners carry a cabinet-only limited warranty.

Sixteen 3-Ton
#08611 **Sixteen 5-Ton**
#08610

Sizes (DxHxW)	27.75" x 23.125" x 24.75"	27.75" x 23.25" x 30.75"
Weight	42 lbs.	49 lbs.
Resistance	0.13" H ₂ O @ 1200 CFM.	0.18" H ₂ O @ 2000 CFM.
Efficiency	MERV 16 at 0.3 microns.	
Filter Qty	3	4
Construction	Modular alloy Aluminum chassis, high-strength ABS frame corners, 3003 Aluminum filter rails, painted galvanized steel access panels.	

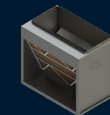
Right Angle MAC

MERV 11 filter standard. MERV 13 available.

Sizes (DxHxW)	#20060 - 16"x25" 26" x 16.25" x 18.5"	#20061 - 20"x25" 26" x 16.25" x 22"
	Filter Size: 15.6875" x 24.6875" x 4.375"	Filter Size: 15.6875" x 24.6875" x 4.375"
Construction	22 ga. painted steel. Ducane grey.	

Platform MAC

MERV 11 filter standard. MERV 13 available.

Sizes (DxHxW)	#12140 - 22" x 32" 32" x 13.5" x 22.5" Filter: 20" x 20" x 4.375"	#12142 - 28" x 33" 33" x 13.5" x 28.5" Filter: 20" x 25" x 4.375"
	#12141 - 22" x 40" 40" x 13.5" x 22.5" Filter: 20" x 25" x 4.375"	#12143 - 28" x 43" 43" x 13.5" x 28.5" Filter: 20" x 25" x 4.375"
Construction	22 ga. painted steel.	

Bypass HEPA
DFHPA #19850 **Bypass HEPA Plus**
DFHPAUV #19851

Sizes and Weight	Unit 17"L x 13"W x 23.9"H	Unit 17"L x 13"W x 29"H
	Weight 33 lbs.	Weight 36 lbs
Electrical	120VAC, 60Hz, 1.6A.	120VAC, 60Hz, 1.9A.
Mounts	Round Collar: 8" Direct Plenum: 16" x 4"	
Air Speed	400 CFM	
HEPA Filter	12" x 16" x 2.5" HEPA	
Pre/Carbon Filter	12" x 16" x 2" MERV 8 with Carbon	
PCO Filter	15" x 5.325" x 0.625". Bypass HEPA Plus only.	
UVGI	Dual-tube UV-C Lamp. Bypass HEPA Plus only.	
Listings	Safety Listed to UL 705 and CSA C22.2 #13. Bypass HEPA Plus is UL 2998 zero-ozone validated.	

HIGH EFFICIENCY AIR CLEANERS

All air cleaners carry a cabinet-only limited warranty.

MAC 11

w/Standard Filter	Without Filter
14"x25" - #12590	14"x25" - #09200
16"x25" - #12580	16"x25" - #09201
20"x20" - #12581	20"x20" - #09203
20"x25" - #12582	20"x25" - #09204
17"x22" - #12583	17"x22" - #09202
21"x22" - #12584	21"x22" - #09205
25"x22" - #12585	25"x22" - #09206

Cabinet Dimensions (DxH)	Filter Size
14" x 25" - 15.04" x 27.51"	14" x 25"
16" x 25" - 17.03" x 27.51"	16" x 25"
20" x 20" - 21.03" x 22.51"	20" x 20"
20" x 25" - 21.03" x 27.51"	20" x 25"
17" x 22" - 17.03" x 22.51"	16" x 20"
21" x 22" - 21.03" x 22.51"	20" x 20"
25" x 22" - 26.03" x 22.51"	20" x 25"

Performance MERV 11

Construction 22 gauge, unpainted, galvanized steel cabinet. Painted door.

Application Dust Free[®] media filter cabinets can be installed in all forced warm air furnaces and cooling systems up to 5 tons (2000 CFM).

Temperature Rating -40° to 140° F (-40° to 60° F).

MAC 13

w/Carbon Filter	w/Standard Filter	Without Filter
14"x25" - #12598	16"x25" - #11086	14"x25" - #09207
16"x25" - #11080	20"x20" - #11087	16"x25" - #09208
20"x20" - #11081	20"x25" - #11088	20"x20" - #09210
20"x25" - #11082	17"x22" - #11079	20"x25" - #09211
17"x22" - #11083	25"x22" - #11078	17"x22" - #09209
21"x22" - #11084		21"x22" - #09212
25"x22" - #11085		25"x22" - #09213

Cabinet Dimensions (DxH)	Filter Size
14" x 25" - 15.04" x 27.51"	14" x 25"
16" x 25" - 17.03" x 27.51"	16" x 25"
20" x 20" - 21.03" x 22.51"	20" x 20"
20" x 25" - 21.03" x 27.51"	20" x 25"
17" x 22" - 17.03" x 22.51"	16" x 20"
21" x 22" - 21.03" x 22.51"	20" x 20"
25" x 22" - 26.03" x 22.51"	20" x 25"

Performance MERV 13 @ 0.24" w.c.

Construction 22 gauge, painted, galvanized steel cabinet and door.

Application Dust Free[®] media filter cabinets can be installed in all forced warm air furnaces and cooling systems up to 5 tons (2000 CFM).

Temperature Rating -40° to 140° F (-40° to 60° F).

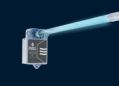
GERMICIDAL UV

Lightstick[®] #19300

Lightstick[®] Gold #19301

Sizes	Unit: 4.75"L x 3.16"W x 1.75"H Weight: 2.5 lbs. Mounting Bracket: 3.5"L x 2.25"W x 3.5"H	Mounting Bracket (Magnetic): 3.5"L x 2.25"W x 3.5"H Lightstick [®] Gold only.
Electrical	24VAC (Expanded range ballast: 20V-32V), 50/60Hz, 1.0A. 3000V surge protection. 3-ft power cord. 4-ft lamp cord.	
Ozone	UL 2998 validated no ozone. Meets California ozone emissions limit: CARB certified.	
Safety Interlock	None.	Magnetic. (Included.)
Lamp	High humidity, water-resistant, 15" lamp length. Filter Shield option (Lightstick [®] Gold only.)	
Lamp Life	9,000 hour.	18,000 hour.
Warranty	4-yr power module. 1-yr lamp.	7-yr power module. 2-yr lamp.

Duality[®] #19200

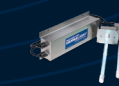
Size and Weight	Unit: 4"L x 2.3"W x 1"H LED Arrays: 8.8"L x 0.4"W VOC Filter: 7.8"L x 2.3"W x 0.1"H Weight: 1.1 lbs.
Electrical	90VAC - 240VAC
Ozone	Zero ozone emissions.
LED	50,000 hour lifespan.
Warranty	5-yr.

VersaLight

Single Lamp 1SVL16 - #06153 1SVL00 - #06208	Dual Lamp 2SVL16 - #06154 2SVL00 - #06209
---	---

Sizes and Weight	Unit: 13"L x 4.5"W x 2.625" H Remote Housing: 13"L x 4.5"W x 2.625"H Weight: 1S - 5.75 lbs. 2S - 6 lbs.
Electrical	120V-240V, 50/60Hz, multi-voltage electronic ballast. Full load amps: 120V - 0.9 amps. 240V - 0.5 amps. 3 amp 250V fuse. 120V, 3-prong, 6 ft., detachable power cord.
Ozone	None with standard bulbs. Ozone generating bulbs available as an option.
Lamp Life	9,000 hours.
Temperature Rating	45° to 150° F (Outside of duct).
Warranty	3-yr limited. 1-yr lamp.

Ultra-Flex

Single Lamp 1S14 - #09000 1S16 - #09001	Dual Lamp 2S14 - #09006 2S16 - #09007
---	---

Sizes and Weight	Unit: 9.25"L x 4"W x 2"H Remote Housing: 3.6"L x 3"W x 1.25"H Weight: ~4 lbs.
Electrical	120V-240V, 50/60Hz, multi-voltage electronic ballast. 3 amp 250V fuse. 6 ft. power cord.
Ozone	None.
Lamp Life	9,000 hours.
Temperature Rating	45° to 150° F (Outside of duct).
Warranty	5-yr limited. 1-yr lamp.

GERMICIDAL UV

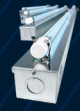

XL	120V	230V	277V
	XL 21" #06170	XL 21" #06178	XL 21" #06171
	XL 33" #06172	XL 33" #06179	XL 33" #06173
	XL 45" #06174	XL 45" #06188	XL 45" #06175
	XL 61" #06176	XL 61" #06189	XL 61" #06177

Size and Weight	Unit: XL 21": 3.375"H x 2.5"W x 24"L XL 33": 3.375"H x 2.5"W x 36"L XL 45": 3.375"H x 2.5"W x 48"L XL 61": 3.375"H x 2.5"W x 64"L Weight: XL 21": 3.9 lbs. XL 33": 4.6lbs. XL 45": 6.4 lbs. XL 61": 8.3 lbs.
------------------------	---

Electrical	120V, 50/60Hz, 1PH. Optional 230V. Optional 277V, 50/60Hz, 1PH.
-------------------	---

Ozone	UL 2998 validated no ozone. Meets California ozone emissions limit: CARB certified.
--------------	---

Temperature Rating	45° to 150° F (Outside of duct).
---------------------------	----------------------------------

Lamp Life	9,000 hours.
------------------	--------------

Warranty	3-yr limited. 1-yr lamp.
-----------------	--------------------------



4Xtreme	21"	33"	45"
	#06159	#06160	#06158

Lamp Length	20"	32"	44"
--------------------	-----	-----	-----

Size and Weight	Enclosure: 11.56"H x 8"W x 4.25"L Weight: 8.2 lbs.
------------------------	---

Electrical	120V-240V, 50/60 Hz, multi-voltage electronic ballast. Full load amps: 120V – 0.9 amps. 240V – 0.5 amps. 3 amp, 250V, inline fuse.
-------------------	--

Temperature Rating	-45° to 150° F (Outside of duct).
---------------------------	-----------------------------------

Lamp Life	9,000 hours.
------------------	--------------

Warranty	3-yr limited. 1-yr lamp.
-----------------	--------------------------

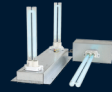

Nomad	Nomad 2
Standard Power Cord Nomad 9D – #04400MV Nomad 16D – #04401MV	Standard Power Cord Nomad 2D9 – #04966MV Nomad 2D16 – #04967MV
Whip-type Power Cord Nomad 9D – #06304 Nomad 16D – #06305	Whip-type Power Cord Nomad 2D9 – #06306 Nomad 2D16 – #06307

Sizes and Weight	Single Lamp Unit: 7"L x 3.5"W x 3.125"H Weight: Nomad 9D: 2.125 lbs. Nomad 16D: 3.75 lbs. Nomad 2D9: 5.33 lbs. Nomad 2D16 – 7.625 lbs.	Dual Lamp Unit: 17"L x 5.93"W x 1.5"H
-------------------------	--	---

Electrical	120V-240V, 50/60Hz, 1PH. 3 amp 250v fuse.
-------------------	---

Ozone	None with standard bulbs. Ozone generating bulbs available as an option.
--------------	--





Lamp Life	9,000 hours.
------------------	--------------

Temperature Rating	45° to 150° F (Outside of duct).
---------------------------	----------------------------------

Warranty	5-yr limited. 1-yr lamp.
-----------------	--------------------------

PERMANENT AIR FILTERS

Except where noted, all filters are available in 40 standard sizes. 1", 2", and adjustable sizes. Custom sizes available. Limited lifetime warranty.

Models	Efficiency†	Resistance††	Media	Frame
 Dust Fighter® 95	95%	0.15"	5 Layers	Aluminum
 Dust Fighter® 90	90%	0.12"	3 Layers	Aluminum
 Allergy Gold®	90%	0.12"	3 Layers	Gold-anodized Aluminum. 1" sizes only.
 Maxaire Gold®	81%	0.08"	3 Layers	Gold-anodized Aluminum. 1" sizes only.
 Envirogreen™ 8 Pleated	MERV 8	--	Pleated V-Core	Green-anodized Aluminum. 1" sizes only. 33 standard sizes. Custom sizes up to 600 sq in.

†Except for Envirogreen 8 pleat, efficiency represents peak arrestance as tested to ASHRAE 52-76 test procedures. †† Initial resistance @ 1200 CFM.

PERFORMANCE

All air cleaners carry a cabinet-only limited warranty.



SST2

21" Side Access Series Sizes			
Part #	Dim A / B	Cabinet	
#19830	14" / 14.25"	A Furnace to A Coil	
#19831	14.25" / 17.75"	A Furnace to B Coil	
#19832	14.25" / 21.25"	A Furnace to C Coil	
#19833	17.5" / 17.75"	B Furnace to B Coil	
#19834	17.75" / 21.25"	B Furnace to C Coil	
#19835	17.75" / 24.75"	B Furnace to D Coil	
#19836	21" / 21.25"	C Furnace to C Coil	
#19837	21.25" / 24.75"	C Furnace to D Coil	
#19838	24.5" / 24.75"	D Furnace to D Coil	

21" Closet Series Sizes			
Part #	Dim A / B	Cabinet	
#19840	14" / 14.25"	A Furnace to A Coil	
#19841	14.25" / 17.75"	A Furnace to B Coil	
#19842	14.25" / 21.25"	A Furnace to C Coil	
#19843	17.5" / 17.75"	B Furnace to B Coil	
#19844	17.75" / 21.25"	B Furnace to C Coil	
#19845	17.75" / 24.75"	B Furnace to D Coil	
#19846	21" / 21.25"	C Furnace to C Coil	
#19847	21.25" / 24.75"	C Furnace to D Coil	



Furnace Riser

MERV 11 filter standard. MERV 13 available.

Sizes (DxHxW)	#20070 - A-Width	#20072 - C-Width
	14" x 5.83" x 28.25"	21" x 5.83" x 28.25"
Construction	#20071 - B-Width	#20073 - D-Width
	17.5" x 5.83" x 28.25"	24.5" x 5.83" x 28.25"

Construction 22-ga. painted steel.

SERVICES

End-To-End Innovation.

Dust Free[®] offers a complete range of services to manage everything from the inception of an idea, the manufacturing process, to final distribution through its sales force and training programs.

- **Product Development and Research.**

R&D facilities and full-time engineering team offer comprehensive support, from establishing project deliverables, 3D CAD modeling, CFD flow analysis, prototyping, packaging design, lab testing, and preparation for full-scale production and fabrication.

- **Manufacturing, Production, and Shipping.**

Full manufacturing capabilities for multiple assembly lines, multiple automated and robotic fabrication systems, electronics assembly, and photocatalyst laboratory. Strong carrier relationships allows Dust Free[®] to meet global shipping demands from a single component, to LTL shipments, and full-container loads.

- **Sales and Training.**

Expand sales and business development as needed with Dust Free[®]'s nationwide sales network, proven training programs, and extensive marketing support capabilities.



FACTS AT A GLANCE

40+

40+ years making air cleaner to breathe.

130K

Over 130,000 square feet of manufacturing space. And growing.

10K

10,000 sheet metal components produced daily.

100+

Over 100 independent North American sales reps.

10K+

Over 10,000 square feet of product development, research, and testing facilities.

500+

Distributors worldwide.

Environmental Initiative

Dust Free[®] recycles 1.7 million pounds of corrugation, steel, and aluminum annually.

Dust Free[®] is proud to design and manufacture American made products in Royse City, Texas.

Dust Free[®] offers full product development services with capabilities that include automated sheet metal fabrication, multi-line manufacturing, ISO 9001 quality assurance, stage gate driven OEM projects, and a nationwide distribution, marketing, and training network.

DUST FREE[®] CLEAR[™] IAQ ADVISOR PROGRAM

Get Certified!

The Dust Free[®] Clear[™] IAQ training program is designed to provide the knowledge needed to execute proper IAQ solution strategies and build IAQ strategies.

- Become an expert in Indoor Air Quality and learn the benefits of Dust Free[®] IAQ solutions.
- Dust Free[®]'s product training on filtration, germicidal UV, air purification, and performance efficiency.
- How to sell products and increase revenue and profitability with your HVAC business.



For full program details and to get started, visit us online.

<https://dustfree.com/dust-free-clear-iaq-training-program/>



BUILD YOUR BUSINESS

Ask about our private label program.

Dust Free[®], LP

1112 Industrial Drive
PO Box 519, Royse City, TX 75189
Toll Free: 1-800-441-1107
Website: www.dustfree.com

EPA Establishment No. 73316-TX-1

Dust Free[®] uses independent labs and universities for product testing.
Visit <http://www.dustfree.com/testing>.

The product and technologies described are not medical devices, and are not intended to diagnose, treat, cure, or prevent any disease or illness.

1. All third-party laboratory testing paid for by Dust Free[®].

U.S. Patent Nos. 5,334,347, 5,817,276, 6,245,293, 6,267,924, 6,280,686, 6,313,470, 6,627,000, 6,539,727, 6,932,494, 6,550,257.

Professional installation required.

All specifications subject to change without notice.