

SPECIFICATIONS

Capacity		
@ 80°F/60% RH	80 ppd	
@ 73°F/60% RH	65 ppd	
Energy Factor		
@ 80°F/60% RH	2.8 L/KW-h	
@ 73°F/60% RH	2.35 L/KW-h	
Airflow @ varying E.S.P. (external static pressure - dry coil)		
0.0" w.c.	185 CFM	
0.2" w.c.	135 CFM	
0.4" w.c.	85 CFM	
Voltage, phase, frequency		
120VAC, 1 phase, 60 Hz		
Current draw⁽¹⁾		
5.1 Amps		
Noise		
45 dBA ducted		
Dimensions: (cabinet only)⁽²⁾		
Width 14"		
Height 15"		
Length 26"		
Unit Weight		
63 lbs.		
Shipping Weight		
81 lbs.		
Inlet air operating conditions during		
-Dehumidification:	50°F-104°F, 40°F dew point min.	
-Ventilation:	40°F-140°F, 0%-99% RH (non-condensing)	

⁽¹⁾Rated capacity, energy factor and current draw measured at 80°F/60% RH inlet air at 0.0 ESP.

⁽²⁾Height does not include adjustable feet. The width excludes the filter doors and length excludes the duct collars.

FEATURES

Control⁽³⁾	Built-in digital control with display
Control mounting option	Top or front-mounting options
Cabinet insulation	½" EPS
Air discharge orientation	Top or end
Inlet/Outlet duct collars	10" dia.
Backdraft damper at outlet	Included
Filter	Washable MERV 8 (Part Number 5881)
Refrigerant	R410A
Coil type	Corrosion-resistant aluminum
8' Power cord⁽⁴⁾	Plug type (E080 only)
Hardwire option	Yes, field-configurable
Discharge air temperature rise	10°F-30°F
Drain connection⁽⁵⁾	¾" MNPT Threaded
Warranty	5 Years

⁽³⁾Built-in automatic control capable to be set up for dehumidification and ventilation or zoning.

⁽⁴⁾Model E080H is a hardwired unit and doesn't ship with a power cord.

⁽⁵⁾Adapters for threaded connection or plastic hose included.



MODELS:

E080: Includes 8 ft. power cord

E080H: Terminal connection for hardwiring

PRINCIPLE OF OPERATION

The Aprilaire E080 Dehumidifiers are designed to dehumidify the air coming into the unit by passing the incoming air over an evaporator coil to drop the air temperature below the dew point of the air. Moisture is removed from the air and drained out of the unit to a common floor or waste drain. The air is then reheated in the condenser coil and exits the unit.

Dehumidification occurs until the set point is reached, then shuts off until periodic sampling determines a need for operation.

APPLICATION

The E080 Dehumidifiers are perfect for a wide range of applications, including whole-home dehumidification and control of moisture in basements and crawl spaces.

CIRCULATION

The E080 can also be programmed to circulate the air within a crawl space. This evens out relative humidity levels and temperature in the space, eliminating variations in the environment.

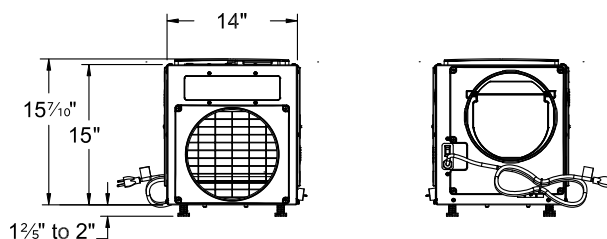
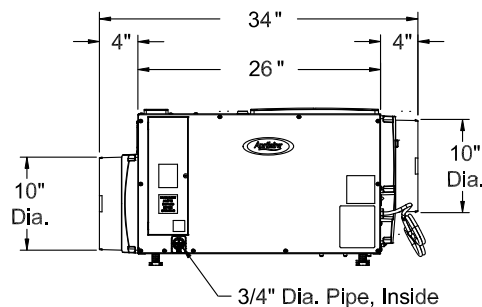

INSTALLATION OPTIONS FOR THE APRILAIRE E080 DEHUMIDIFIERS

Shown in horizontal applications, can be installed in vertical applications as well.

Main Return to Main Return - RECOMMENDED

- This application can be used when a supply duct is not available.
- Air is pulled from the return duct, dehumidified, and returned to the return duct.
- Assures that the dehumidified air is mixed with rest of the air in the duct before it re-enters the house.
- This application is for whole-home dehumidification.

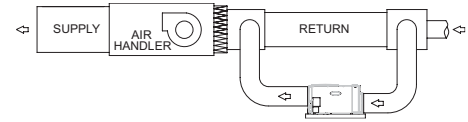

Dedicated Return to Main Supply or Dedicated Return to A/C Return

- This application can be used when a return or supply duct is not available.
- Air is pulled through a dedicated return grille, dehumidified, and returned to the supply plenum or return.
- This application is for whole-home dehumidification.

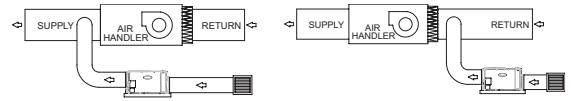

Inlet and Outlet ducted to dedicated grilles

- For homes without duct work. Use of the Model 5546 Living Space Duct Kit recommended.
- Dries a specific area that has a moisture issue (basements, crawl spaces, sealed attics, etc.).
- Dehumidifier can be located in a closet, mechanical room or unfinished area and ducted into a finished room.

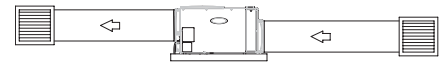

Main Return to Main Supply

- Air is pulled from the return duct, dehumidified, and returned to the supply plenum.
- This application is for whole-home dehumidification.

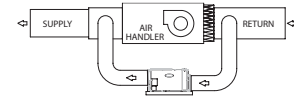

Optional Accessories



Model 5822 Hanging Kit

27" W x 3" H x 38" L
Weight: 18 lbs.
Working Load: 400 lbs.

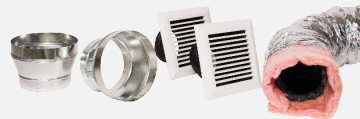

Model 5546 Living Space Duct Kit

See dedicated grilles installation example above.

Optional Wall-Mount Controls



Model 8620/8620W with IAQ Control

- Universal 2H/2C or 4H/2C HP
- Event-Based™ Air Cleaning
- Humidity or Ventilation
- Touch screen
- Wi-Fi (8620W only)



Model 76 Wall Mount Dehumidifier Control

- On, Off buttons
- Wall-mounted living space control
- Displays RH and controls to an RH value
- Remote control for crawl space applications and sealed attics



Model 8910/8910W with IAQ Control

- Universal 3H/3C or 4H/2C HP
- Event-Based™ Air Cleaning
- Humidity and Ventilation
- 2-Part 3-Wire design
- Touch screen
- Wi-Fi (8910W only)



Model 8920W with IAQ Control

- Universal 3H/3C or 4H/2C HP
- Event-Based™ Air Cleaning
- Humidity and Ventilation
- 2-Part 3-Wire design
- Full-color touch screen
- Wi-Fi

MODEL 76 SPECIFICATIONS

Electrical	External	Remote
Input voltage and current	Voltage: 24VAC +/-20% Current: 25mA (nominal), 50mA (max.) at 24VAC	Voltage: 35VDC (supplied by dehumidifier control board)
Output	Dry contact, normally open	Communication (RS485)
Control	External	Remote
Control range	40% 80% RH	1 (less dry)-7 (more dry) 65°F-40°F dew point
Accuracy	+/-5% RH	See dehumidifier specifications
Differential	3% RH	
Low limit	40°F dew point	50°F dry bulb, 40°F dew point min.
High limit	99°F dry bulb	105°F dry bulb