

User's Information Manual

**▲ WARNING**

If the information in this manual is not followed exactly, a fire or explosion may result, causing property damage, personal injury or loss of life.

Do not store or use gasoline or other flammable vapors and liquids in the vicinity of this or any other appliance.

— WHAT TO DO IF YOU SMELL GAS —

- Do not try to light any appliance.
- Do not touch any electrical switch; do not use any telephone in your building.
- Immediately call your gas supplier from a neighbor's telephone. Follow the gas supplier's instructions.
- If you cannot reach your gas supplier, call the fire department.

Installation & service must be performed by a qualified installer, service technician or the gas supplier.



How to use this manual . . .

To . . .	Read/use . . .	See pages . . .
Learn precautions	Warnings and definitions	1 – 3
Prevent air contamination	Read the list of air contaminants you must avoid. If found, either remove the products permanently, or have your installer relocate boiler vent and air terminations to an uncontaminated area.	4
Maintain the boiler	Maintain the boiler using the schedule in this manual. Schedule an annual start-up by a qualified service technician before every heating season.	5 – 8
Start or shutdown the boiler	Use the OPERATING INSTRUCTIONS	9
Boiler components & the U-Control display	These illustrations and callouts will show you the location of main components and use of the U-Control display.	10 – 11

Hazard definitions

The following defined terms are used throughout this manual to bring attention to the presence of hazards of various risk levels or to important information concerning the life of the product.

- ▲ DANGER** Indicates presence of hazards that will cause severe personal injury, death or substantial property damage.
- ▲ WARNING** Indicates presence of hazards that can cause severe personal injury, death or substantial property damage.
- ▲ CAUTION** Indicates presence of hazards that will or can cause minor personal injury or property damage.
- NOTICE** Indicates special instructions on installation, operation or maintenance that are important but not related to personal injury or property damage.

Boiler service and maintenance

▲ WARNING The Boiler manual is for use only by a qualified heating installer/service technician. Refer only to this User’s Information Manual for your reference. Improper installation, adjustment, alteration, service or maintenance can cause property damage, personal injury (exposure to hazardous materials) or loss of life. Installation and service must be performed by a qualified installer, service agency or the gas supplier (who must read and follow the supplied instructions before installing, servicing, or removing this boiler. This boiler contains materials that have been identified as carcinogenic, or possibly carcinogenic, to humans).

NOTICE When calling or writing about the boiler— Please have the boiler model number from the boiler rating label and the CP number from the boiler jacket.

STOP! READ THIS BEFORE PROCEEDING . . .

▲WARNING Failure to adhere to the guidelines on this page can result in severe personal injury, death or substantial property damage.

Boiler service and maintenance —

- To avoid electric shock, disconnect electrical supply before performing maintenance.
- To avoid severe burns, allow boiler to cool before performing maintenance.
- You must maintain the boiler as outlined in this manual and have the boiler started up and serviced at least annually by a qualified service technician to ensure boiler/system reliability.

Boiler operation —

- Do not block flow of combustion or ventilation air to boiler. This boiler is equipped with a control which will automatically shut down the boiler should air or vent be blocked. If vent or air blockage is easily accessible and removable, remove it. The boiler should attempt to restart. If blockage is not obvious or cannot be removed, have the boiler and system checked by a qualified service technician.
- Do not allow contaminated air to enter the boiler air inlet pipe. See page 4 for details.
- Should overheating occur or gas supply fail to shut off, do not turn off or disconnect electrical supply to boiler. Instead, shut off the gas supply at a location external to the appliance.
- Do not use this boiler if any part has been under water. Immediately call a qualified service technician to inspect the boiler and to replace any part of the control system and any gas control, which has been under water.

Boiler water —

- Have boiler water chemistry checked at least annually by a qualified service technician.
- DO NOT use petroleum-based cleaning or sealing compounds in boiler system. Gaskets and seals in the system may be damaged. This can result in substantial property damage.
- DO NOT use “homemade cures” or “boiler patent medicines”. Serious damage to boiler, personnel and/or property may result.
- Continual fresh makeup water will reduce boiler life. Mineral build-up in boiler heat exchanger reduces heat transfer, overheats the metal, and causes heat exchanger failure. Addition of oxygen can cause internal corrosion in system components. Leaks in boiler or piping must be repaired at once to prevent makeup water.
- Do not add cold water to hot boiler. Thermal shock can cause boiler heat exchanger to crack.



Prevent combustion air contamination

⚠️ WARNING If the boiler combustion air inlet is located in any area likely to cause contamination, or if products which would contaminate the air cannot be removed, you must have the combustion air and vent re-piped and terminated to another location. Contaminated combustion air will damage the boiler, resulting in possible severe personal injury, death or substantial property damage.

Do not operate an Ultra boiler if its combustion air inlet is located in a laundry room or pool facility, for example. These areas will always contain hazardous contaminants.

Pool and laundry products and common household and hobby products often contain fluorine or chlorine compounds. When these chemicals pass through the boiler, they can form strong acids. The acid can eat through the boiler wall, causing serious damage and presenting a possible threat of flue gas spillage or boiler water leakage into the building.

Please read the information listed below. If contaminating chemicals will be present near the location of the boiler combustion air inlet, have your installer pipe the boiler combustion air and vent to another location, per the Boiler manual.

Products to avoid	Areas likely to have contaminants
Spray cans containing chloro/fluorocarbons	Dry cleaning/laundry areas and establishments
Permanent wave solutions	Swimming pools
Chlorinated waxes/cleaners	Metal fabrication plants
Chlorine-based swimming pool chemicals	Beauty salons
Calcium chloride used for thawing	Refrigeration repair shops
Sodium chloride used for water softening	Photo processing plants
Refrigerant leaks	Auto body shops
Paint or varnish removers	Plastic manufacturing plants
Hydrochloric acid/muriatic acid	Furniture refinishing areas and establishments
Cements and glues	New building construction
Antistatic fabric softeners used in clothes dryers	Remodeling areas
Chlorine-type bleaches, detergents, and cleaning solvents found in household laundry rooms	Garages with workshops
Adhesives used to fasten building products and other similar products	



Annual startup and general maintenance

Figure 1 Service and maintenance schedules

OWNER MAINTENANCE (see the following pages for instructions)	
BEGINNING OF SEASON	Contact your boiler service technician to inspect, service and start up your boiler. You must have an annual start-up performed by a qualified service technician to ensure reliable operation of the boiler and system.
DAILY	<ul style="list-style-type: none"> Check boiler area Check air openings Check pressure/temperature gauge Verify boiler front door is secure
MONTHLY	<ul style="list-style-type: none"> Check vent piping Check air piping Check relief valve Check condensate drain system Check automatic air vents (if used)
PERIODICALLY	<ul style="list-style-type: none"> Test low water cutoff (if used) Check time and date on the U-Control display
EVERY 6 MONTHS	<ul style="list-style-type: none"> Check boiler piping (gas and water) Operate relief valve
END OF SEASON	Shut boiler down (unless boiler used for domestic water)

⚠ WARNING Follow the service and maintenance procedures given throughout this manual and in component literature shipped with the boiler. Failure to perform the service and maintenance could result in damage to the boiler or system. Failure to follow the directions in this manual and component literature could result in severe personal injury, death or substantial property damage.



Maintenance procedures — DAILY

The boiler must be serviced & maintained

WARNING The boiler must be inspected and started annually, at the beginning of the heating season, by a qualified service technician. In addition, the maintenance and care of the boiler designated on page 5 and explained on pages 6 through 9 must be performed to assure maximum boiler efficiency and reliability. Failure to service and maintain the boiler and system could result in equipment failure, causing possible severe personal injury, death or substantial property damage.

NOTICE The following information provides detailed instructions for completing the maintenance items listed in the maintenance schedule, page 5.

In addition to this maintenance, the boiler must be serviced and started up at the beginning of each heating season by a qualified service technician.

Check boiler area

WARNING To prevent potential of severe personal injury, death or substantial property damage, eliminate all materials discussed below from the boiler vicinity and the vicinity of boiler combustion air inlet. If contaminants are found:

- Remove products immediately from the area. If they have been there for an extended period, call a qualified service technician to inspect the boiler for possible damage from acid corrosion.
- If products cannot be removed, immediately call a qualified service technician to re-pipe vent and air piping and locate vent termination/air intake away from contaminated areas.

Combustible/flammable materials — Do not store combustible materials, gasoline or any other flammable vapors or liquids near the boiler. Remove immediately if found.

Air contaminants — Products containing chlorine or fluorine, if allowed to contaminate the boiler intake air, will cause acidic condensate in the boiler. This will cause significant damage to the boiler if allowed to continue. Read the list of potential materials listed on page 4 of this manual. If any of these products are in the room from which the boiler takes its combustion air, they must be removed immediately or the boiler combustion air (and vent termination) must be relocated to another area.

Check air openings

1. Verify that combustion and ventilation air openings to the boiler room and/or building are open and unobstructed.
2. Verify that boiler vent discharge and air intake are clean and free of obstructions.
3. Remove any debris on the air intake or flue exhaust openings.
4. If removing the debris does not allow the boiler to operate correctly afterwards, contact your qualified service technician to inspect the boiler and vent/air systems.

Check the pressure/temperature gauge

1. Make sure the pressure reading on the pressure/temperature gauge does not exceed 25 psig.
2. Contact a qualified service technician if problem persists.

Verify boiler front door is secure

1. Visually inspect boiler front door to be sure it is sealed all around its perimeter. Verify that the two lower thumb screws are tight.

WARNING Reinstall the jacket front door after servicing. The boiler front door must be securely fastened to the boiler to prevent boiler from drawing air from inside the boiler room. This is particularly important if the boiler is located in the same room as other appliances. Failure to keep the door securely fastened could result in severe personal injury or death. Contact your installer or technician immediately if the front door does not correctly in place or if the door gaskets are damaged.



Maintenance procedures — MONTHLY

Check vent piping

1. Visually inspect the flue gas vent piping for any signs of blockage, leakage or deterioration of the piping. Notify your qualified service technician at once if you find any problem.

⚠WARNING Failure to inspect the vent system as noted above and have it repaired by a qualified service technician can result in vent system failure, causing severe personal injury or death.

Check air piping

1. Visually inspect the air inlet to be sure it is unobstructed. Inspect entire length of air piping to ensure piping is intact and all joints are properly sealed.
2. Call your qualified service technician if you notice any problems.

Check the relief valve

1. Inspect the boiler relief valve and the relief valve discharge pipe for signs of weeping or leakage.
2. If the relief valve often weeps, the expansion tank may not be working properly. Immediately contact your qualified service technician to inspect the boiler and system.

Check the condensate drain system

1. While the boiler is running, check the discharge end of the condensate drain tubing and the open top of the condensate tee at the boiler (see Figure 3, page 10 for locations). Make sure no flue gas is escaping from the condensate drain tubing or tee by holding your fingers in front of the opening.

2. If you notice flue gas escaping, this indicates a dry condensate drain trap. See step 4 for procedure to fill trap. Call your qualified service technician to inspect the boiler and condensate line and refill the condensate trap if problem persists regularly.

⚠WARNING Under some circumstances an Ultra vent system may not produce enough condensate to keep the condensate trap full of liquid. If the trap is not full, small amounts of flue products can be emitted into the boiler room through the condensate drain line or tee. Follow procedure below to fill trap.

3. Verify that the condensate drain line is unobstructed by slowly pouring water into the top of the PVC tee on the side of the boiler. The water should run out the end of the condensate drain line. If the water does not run out, call your qualified service technician to inspect the boiler and clean or replace the condensate drain line.
4. To fill the condensate trap, if necessary, temporarily plug the end of the condensate drain line. Then slowly pour water into the ½ inch plastic tee on boiler right side. Pour until water fills drain line, then overflows into the boiler trap tubing. When water fills up to top of ½ inch tee, stop filling. Remove temporary plug from end of condensate drain line.

Check automatic air vents *(if used)*

1. See illustration at right.
2. Remove the cap from any automatic air vent in the system and check operation by depressing valve "B" slightly with the tip of a screwdriver.
3. If the air vent valve appears to be working freely and not leaking, replace cap "A", twisting all the way on.
4. Loosen cap "A" one turn to allow vent to operate.
5. Have vent replaced if it does not operate correctly.

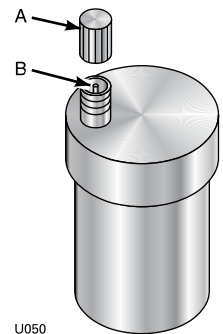

Maintenance procedures — PERIODICALLY

Test the low water cutoff *(if installed)*

1. If the system is equipped with a low water cutoff, test the low water cutoff periodically during the heating season. Follow the low water cutoff manufacturer's instructions.
2. Reset the boiler control after testing.

Check U-Control date and time

1. Check the time shown on the U-Control display.
2. If time is incorrect, set the correct date and time as shown on pages 10 and 11.



Maintenance procedures — EVERY 6 MONTHS

Check the boiler piping

1. Remove boiler front access door and perform gas leak inspection per steps 1 through 7, Operating Instructions, page 9. If gas odor or leak is detected, immediately shut down boiler following procedures on page 9. Call a qualified service technician.
2. Visually inspect for leaks around internal water piping. Also inspect external water piping, circulators, relief valve and fittings. Immediately call a qualified service technician to repair any leaks.

▲WARNING Have leaks fixed at once by a qualified service technician. Failure to comply could result in severe personal injury, death or substantial property damage.

Operate relief valve

1. Reinstall door securely after inspections.

▲WARNING Reinstall the jacket front door after servicing. The boiler front door must be securely fastened to the boiler to prevent boiler from drawing air from inside the boiler room. This is particularly important if the boiler is located in the same room as other appliances. Failure to keep the door securely fastened could result in severe personal injury or death. Contact your installer or technician immediately if the front door does not correctly in place or if the door gaskets are damaged.

2. Before proceeding, verify that the relief valve outlet has been piped to a safe place of discharge, avoiding any possibility of scalding from hot water.

▲WARNING

To avoid water damage or scalding due to valve operation, a metal discharge line must be connected to relief valve outlet and run to a safe place of disposal. This discharge line must be installed by a qualified heating installer or service technician in accordance with the instructions in the Ultra Boiler Manual. The discharge line must be terminated so as to eliminate possibility of severe burns or property damage should the valve discharge.

3. Read the pressure/temperature gauge to make sure the system is pressurized. Lift the relief valve top lever slightly, allowing water to relieve through the valve and discharge piping.
4. If water flows freely, release the lever and allow the valve to seat. Watch the end of the relief valve discharge pipe to ensure that the valve does not weep after the line has had time to drain. If the valve weeps, lift the seat again to attempt to clean the valve seat. If the valve continues to weep afterwards, contact your qualified service technician to inspect the valve and system.
5. If water does not flow from the valve when you lift the lever completely, the valve or discharge line may be blocked. Immediately shut down the boiler, following the operating instructions on page 9. Call your qualified service technician to inspect the boiler and system.

Maintenance procedures — END OF SEASON

1. Follow “TO TURN OFF GAS TO APPLIANCE” on page 9 of this manual.
2. Do not drain system unless exposure to freezing temperatures will occur.
3. Do not drain the system if it is filled with an antifreeze solution.
4. DO NOT shut down boilers used for domestic water heating. They must operate year-round.



OPERATING INSTRUCTIONS

Figure 2 Operating instructions

**FOR YOUR SAFETY
READ BEFORE OPERATING**

⚠ WARNING If you do not follow these instructions exactly, a fire or explosion may result causing property damage, personal injury or loss of life.

A. This appliance does not have a pilot. It is equipped with an ignition device which automatically lights the burner. Do not try to light the burner by hand.

B. Before OPERATING, smell all around the appliance area for gas. Be sure to smell next to the floor because some gas is heavier than air and will settle on the floor. See below.

C. Use only your hand to toggle the power switch and/or turn the manual gas valve. If the switch or valve will not turn by hand, don't try to repair it, call a qualified service technician. Force or attempted repair may result in a fire or explosion.

D. Do not use this appliance if any part has been under water. Immediately call a qualified service technician to inspect the appliance and to replace any part of the control system and any gas control, which has been under water.

WHAT TO DO IF YOU SMELL GAS

- Do not try to light any appliance.
- Immediately call your gas supplier from a neighbor's phone. Follow the gas supplier's instructions.
- Do not touch any electric switch; do not use any phone in your building.
- If you cannot reach your gas supplier, call the fire department.

OPERATING INSTRUCTIONS

1. **STOP!** Read the safety information at left on this label. This appliance is equipped with an ignition device which automatically lights the burner. Do not try to light the burner by hand.
2. Set room thermostat(s) to lowest setting.
3. Turn OFF all electrical power to the appliance.
4. Toggle the power switch located on Boiler to "off" position.
5. Locate boiler manual gas valve (in the gas piping connected to the boiler).
6. Turn boiler manual gas valve knob counterclockwise ↶ to open gas supply.
7. Wait five (5) minutes to clear out any gas. Then smell for gas, including near the floor.
8. If you smell gas, **STOP!** Turn the boiler manual gas valve to OFF. Then follow WHAT TO DO IF YOU SMELL GAS. If you don't smell gas, go to step 9, below.
9. Turn ON all electrical power to the appliance including the power switch located on Boiler.
10. Set thermostat(s) to desired setting.
11. The boiler display will show symbols and/or text describing the status of the boiler as it proceeds through its operating sequence. "Standby" status means the burner is off.
12. If the appliance will not operate when there is a call for heat and piping is not hot, follow the instructions "To Turn Off Gas To Appliance" below and call your service technician or gas supplier.



(ON Position Shown)

Gas valve CLOSED



Gas valve OPEN

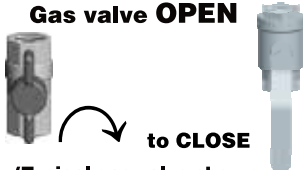

(Typical gas valve shown; Actual valve may vary)

TO TURN OFF GAS TO THE APPLIANCE

1. Set room thermostats to lowest setting.
3. Close external manual gas cock (valve handle perpendicular to gas piping). Turn gas valve knob clockwise ↷ to close gas supply.
2. Turn OFF all electrical power to the appliance including the power switch located on Boiler.
4. Replace boiler access door.



550-101-272 (0617)



Boiler components & the U-Control display

Figure 3 Ultra component locations

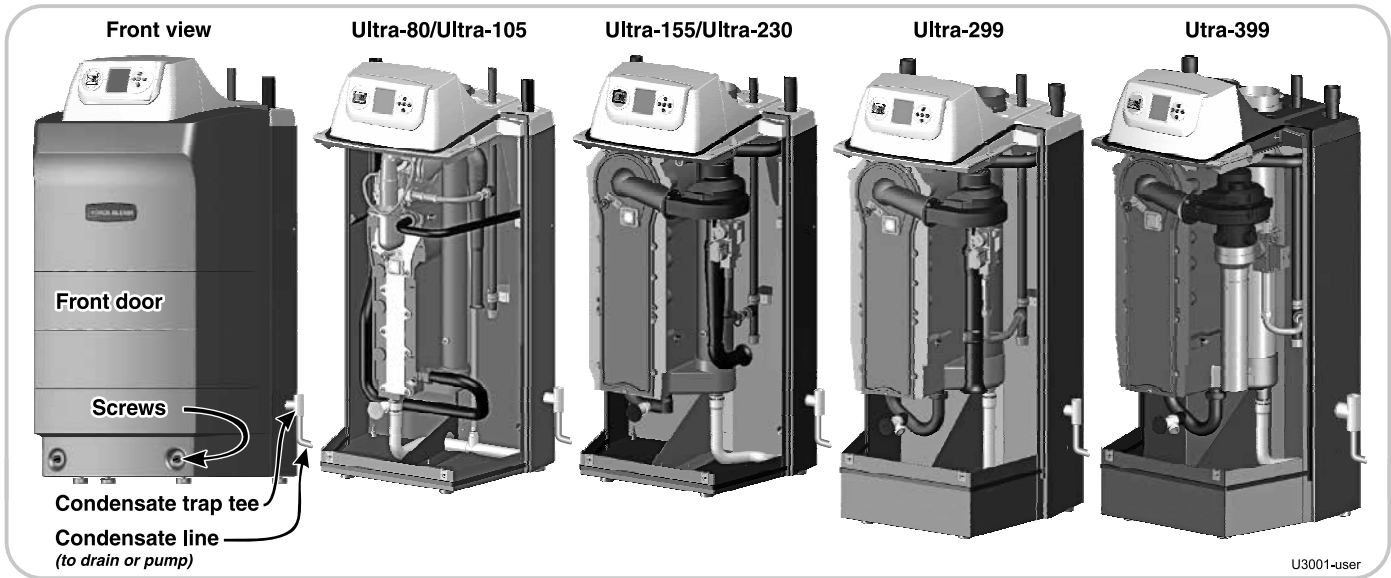

Figure 4 U-Control display turns red when boiler locks out — select MANUAL RESET to reset boiler as shown below.

NOTICE: Screen background color alternates from RED to no backlight (gray screen).

3 ALTERNATING SCREENS

Select **MANUAL RESET** to reset condition. Make sure to correct the cause of the problem if possible.

```

MAINTENANCE
NAME : #####
PHONE : ### - ### - ###
MODEL : ULTRA #####
CP # : #####
INSTALLED : DD / MM / YY
LAST DATE : DD / MM / YY
NEXT DATE : DD / MM / YY
INTERVAL SETTINGS
RESET REMINDER
◀PREVIOUS      ENTER ■
    
```

```

—Alternating Date/Time & Error Info Here—
STATUS : #####
MODULATION : [ ]
TARGET :      ## ° F
SUPPLY :      ## ° F
RETURN :      ## ° F
OUTDOOR :     ## ° F
DEMAND : ###  ##  ##
PUMPS : #    #    #
ADD'L HEAT DEMAND : ##
SETTINGS
MANUAL RESET
SELECT ▲▼
◀PREVIOUS      ENTER ■
    
```



Boiler components & the U-Control display *(continued)*

Figure 5 Ultra boiler’s U-Control display

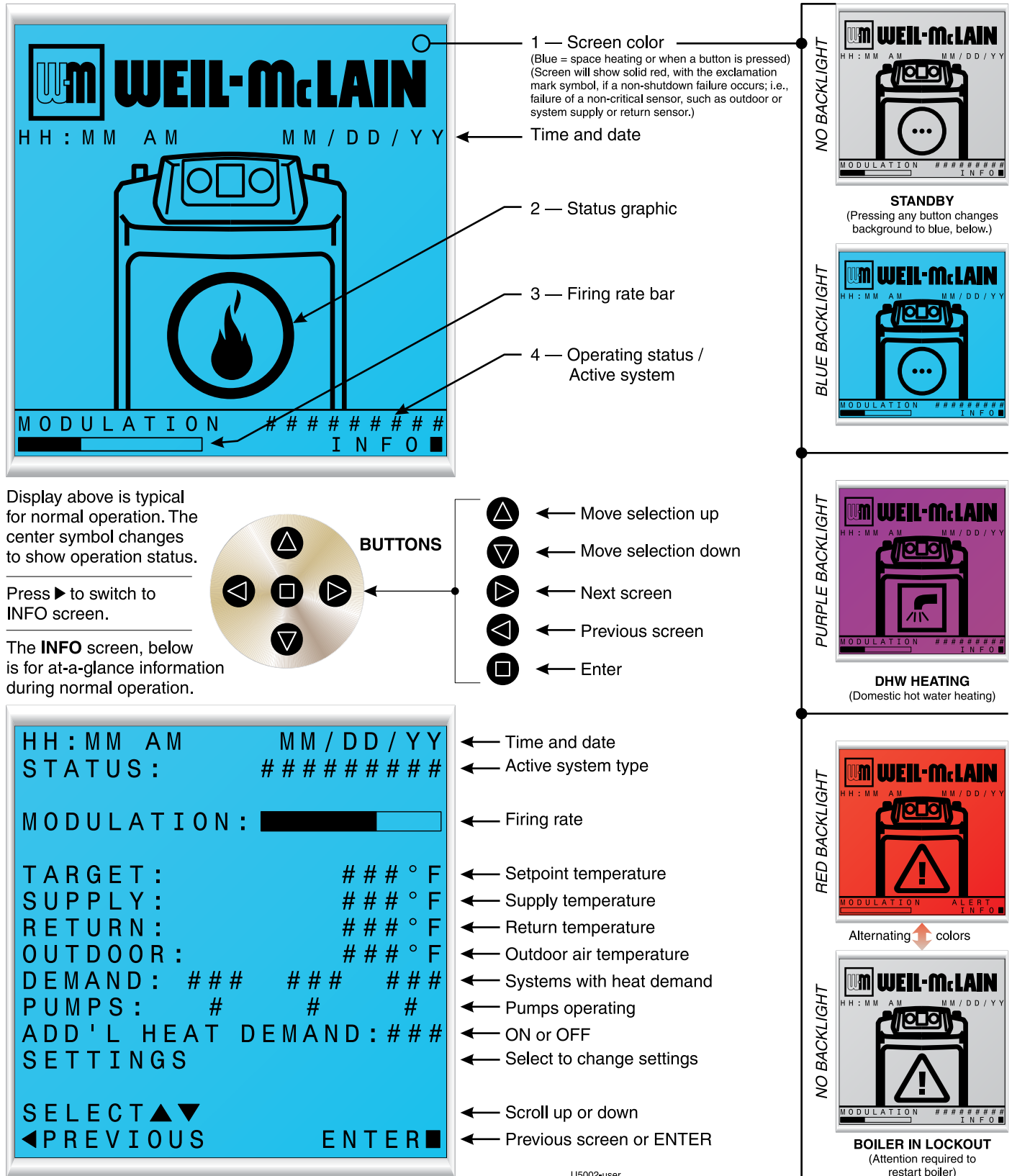

U5002-user



Weil-McLain
500 Blaine Street
Michigan City, IN 46360-2388
weil-mclain.com