

Technical Data Manual

Model Nos. and pricing : See Price List

VIESSMANN®

VITOROND® 100

Hot water heating boiler 91 to 245 MBH
27 to 72 kW



Product may not be exactly as illustrated.

Vitorond 100

VR1 Series

Oil-Fired Boiler of cast iron sectional construction for hydronic heating systems with modulating boiler water temperatures

Heating input: 91 to 245 MBH
27 to 72 kW



Vitorond 100

A genuine triple-pass boiler of cast iron sectional design. The high-quality construction and innovative oil heating technology of this boiler provides a high level of operational reliability, high-efficiency operation and reduced emissions.

Benefits at a glance:

- Get the most out of your fuel dollar! Maximum heat extraction with triple-pass design.
A.F.U.E.: up to 87.1%.
- Extremely durable cast iron heat exchanger for maximum reliability and service life.
- Clean combustion with Beckett or Riello burners.
- Integrated stainless steel combustion chamber insert for clean and efficient combustion.
- Thick 3 ½" insulation for extremely low standby losses and fuel savings.
- Easy access. Full-swing left-hinged or right-hinged combustion chamber door.
- Low maintenance cost with service-friendly burner and easy-to-clean flue gas passageways.
- Spacious, wet-base water walls prevent deposits, reduce stress and increase boiler life.
- Direct vent option (for VR1 22, 27, 33, 91, 105, 140) eliminates the need for a chimney and combustion air supply opening.
- Multiple control options: Choose from a standard 24VAC room thermostat or Vitotronic control options for additional energy savings.
- Additional energy savings and reduced emissions with modulating boiler water temperatures when using Vitotronic control options.
- Boiler return injector available with Vitotronic controls protects against formation of condensation and enables safe lower-temperature operation for increased efficiency.

Cutaway Section

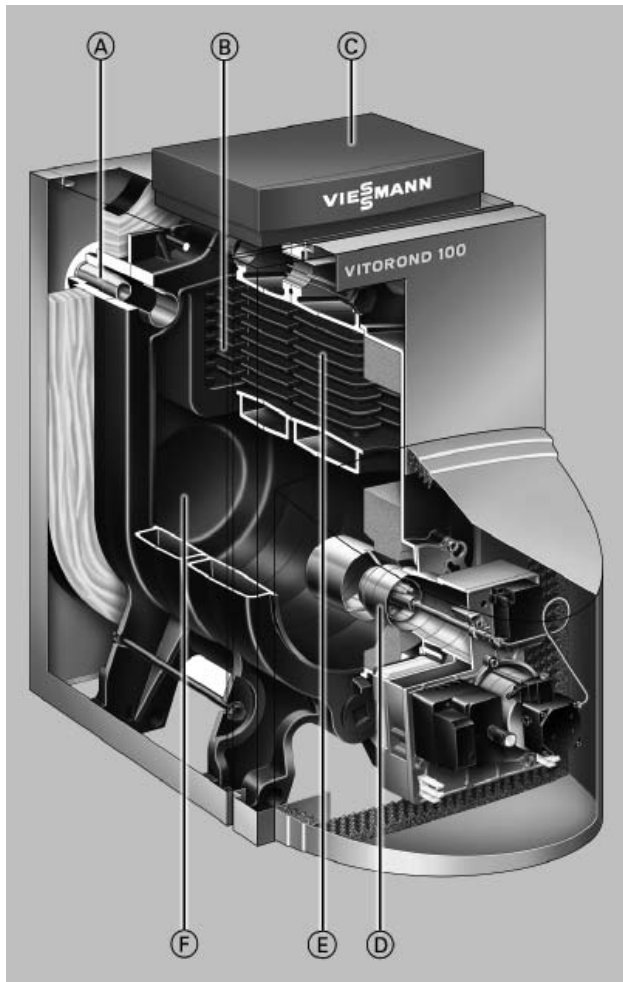

- Ⓐ Special return water flow control injector
- Ⓑ Eutectoplex heat exchanger surface of special homogeneous gray cast iron
- Ⓒ Vitotronic 100 - indoor/outdoor digital boiler and heating system control
- Ⓓ Oil burner
- Ⓔ Third pass
- Ⓕ Combustion chamber*1

*1 Stainless steel combustion chamber insert not shown.
Boiler/burner and controls combination may not be exactly as illustrated.

Technical Data

Boiler Model No.		VR1 22, 91	VR1 27, 105	VR1 33, 140	VR1 40, 161	VR1 50, 196	VR1 63, 245
CSA Input *1	MBH	91	105	140	161	196	245
	(kW)	27	31	41	47	57	72
	GPH	0.65	0.75	1.0	1.15	1.4	1.75
CSA Output	MBH	80	92	122	140	172	215
	(kW)	23	27	36	41	50	63
Net AHRI rating	MBH	70	80	106	122	150	187
	(kW)	21	23	31	36	44	55
A.F.U.E.	%	87	87	87	87	87.1	87.1
Boiler Dimensions							
Depth (without burner)	inches	25 ½	31	31	24 ½	29 ½	34 ½
	(mm)	(650)	(790)	(790)	(583)	(710)	(837)
Width	inches	15 ½	15 ½	15 ½	20	20	20
	(mm)	(391)	(391)	(391)	(512)	(512)	(512)
Height	inches	30 ½	30 ½	30 ½	37	37	37
	(mm)	(775)	(775)	(775)	(935)	(935)	(935)
Overall dimensions (with jacket)							
Total depth (includes burner)	inches	38 ½	44	44	36	37 ½	42 ½
	(mm)	(976)	(1116)	(1116)	(914)	(956)	(1081)
Total width	inches	19 ¾	19 ¾	19 ¾	22 ½	22 ½	22 ½
	(mm)	(500)	(500)	(500)	(565)	(565)	(565)
Total height (without Vitotronic)	inches	33	33	33	39 ¾	39 ¾	39 ¾
	(mm)	(840)	(840)	(840)	(1010)	(1010)	(1010)
- Height 1 (control unit in position for operation and programming)	inches	43 7/8	43 7/8	43 7/8	50 ½	50 ½	50 ½
	(mm)	(1115)	(1115)	(1115)	(1285)	(1285)	(1285)
- Height 2 (control unit in position for servicing)	inches	52 ¾	52 ¾	52 ¾	59 ½	59 ½	59 ½
	(mm)	(1340)	(1340)	(1340)	(1510)	(1510)	(1510)
Height of boiler stand	inches	9 ¾	9 ¾	9 ¾	9 ¾	9 ¾	9 ¾
	(mm)	(250)	(250)	(250)	(250)	(250)	(250)
Weight boiler block	lb	265	335	337	410	522	635
	(kg)	(120)	(152)	(153)	(186)	(237)	(288)
Total weight, boiler with insulation, burner and boiler control	lb	363	445	447	492	608	725
	(kg)	(165)	(202)	(203)	(223)	(276)	(329)
Boiler water content	USG	9.2	11.6	11.6	12.7	16.1	19.3
	(L)	(35)	(44)	(44)	(48)	(61)	(73)
Max. operating pressure *2	psig	30	30	30	30	30	30
	(kPa)	(207)	(207)	(207)	(207)	(207)	(207)
Boiler water connections							
Supply and return	in.	1 ½	1 ½	1 ½	2	2	2
Safety supply	in.	1 ½	1 ½	1 ½	2	2	2
Drain valve	in.	1 ½	1 ½	1 ½	2	2	2
Gross flue gas temperature *3 at							
- 104° F (40° C) boiler water temp.	°F	311	311	311	311	311	311
	(°C)	(155)	(155)	(155)	(155)	(155)	(155)
- 167° F (75° C) boiler water temp.	°F	356	356	356	356	356	356
	(°C)	(180)	(180)	(180)	(180)	(180)	(180)
Boiler vent connection *4	outer Ø in.	5	5	5	6	6	6
Required flue draft	"w.c.	-0.02	-0.02	-0.02	-0.02	-0.02	-0.02

*1 Combustion results are based on 11.0% to 13.5% CO₂ with fuel oil #2 and a hot water heating system supply temperature of 167° F (75°C), return 140°F (60°C).

*2 Max. operating pressure is 45 psig (310 kPa) in all Canadian provinces where a CRN is not required, and in the U.S.A.

*3 Measured flue gas temperature with combustion air temperature of 68°F (20°C).

*4 A 5" vent pipe adaptor is shipped with boiler VR1 models 22 to 33 and 91 to 140. The vent pipe adaptor is not supplied with boiler VR1 models 40 to 63 and 161 to 245.

■ For information regarding direct vent applications, please refer to Direct Vent Systems Installation Instruction Supplement.

■ For information regarding other Viessmann System Technology componentry, please reference documentation of the respective product.

Vitorond 100

Vitorond 100 with Aquastat or Hydrostat

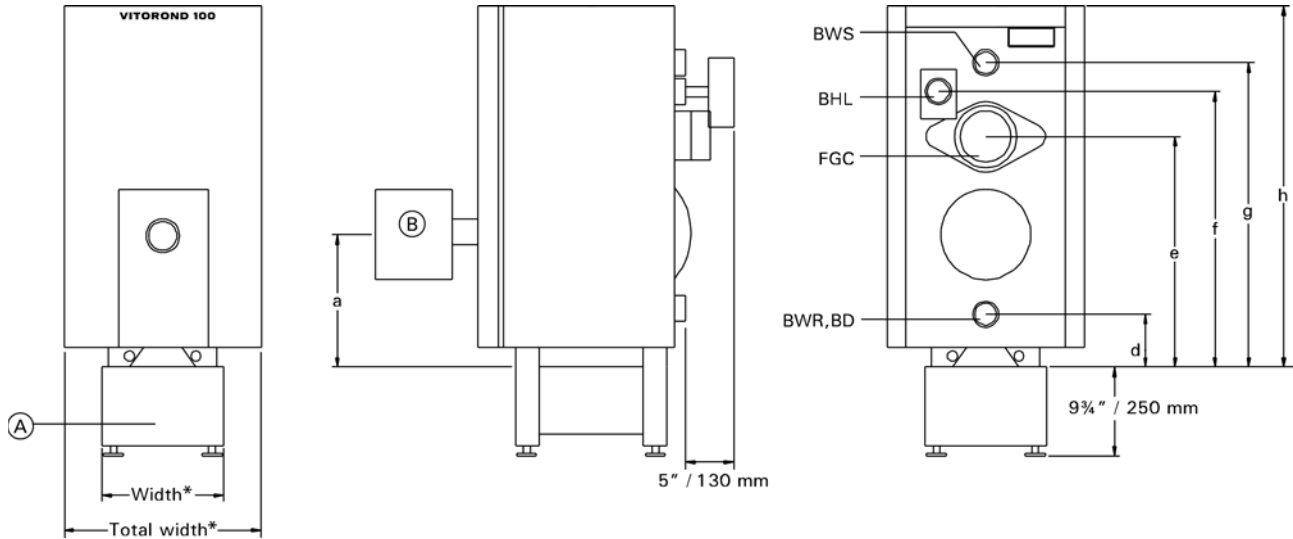

* See page 4

Legend

- BD Boiler Drain
- BTS Boiler Temperature Sensor
- BWR Boiler Water Return
- BWS Boiler Water Supply
- FGC Flue Gas Collar
- BHL Boiler High Limit
(with outdoor reset module)
- (A) Boiler Stand
- (B) Beckett or Riello Burner
- BWR (DHW) Boiler water return
from from the indirect - fired
DHW tank

Dimensions

Boiler Model	VR1	22, 91	27, 105	33, 140	40, 161	50, 196	63, 245
a	in. 13 1/4 (mm) (338)	13 1/4 (338)	13 1/4 (338)	13 1/4 (338)	13 3/4 (347)	13 3/4 (347)	13 3/4 (347)
b	in. 3 (mm) (75)	3 (75)	3 (75)	3 (75)	3 (75)	3 (75)	3 (75)
c	in. 12 1/2 (mm) (312)	12 1/2 (312)	12 1/2 (312)	12 1/2 (312)	12 1/2 (312)	9 1/2 (247)	9 1/2 (247)
d	in. 5 1/2 (mm) (137)	5 1/2 (137)	5 1/2 (137)	5 1/2 (137)	4 1/4 (107)	4 1/4 (107)	4 1/4 (107)
e	in. 23 (mm) (585)	23 (585)	23 (585)	23 (585)	27 3/4 (702)	27 3/4 (702)	27 3/4 (702)
f	in. 26 1/4 (mm) (667)	26 1/4 (667)	26 1/4 (667)	26 1/4 (667)	32 1/4 (822)	32 1/4 (822)	32 1/4 (822)
g	in. 28 1/2 (mm) (726)	28 1/2 (726)	28 1/2 (726)	28 1/2 (726)	34 3/4 (882)	34 3/4 (882)	34 3/4 (882)
h	in. 33 (mm) (840)	33 (840)	33 (840)	33 (840)	39 3/4 (1010)	39 3/4 (1010)	39 3/4 (1010)
k	in. 5 1/2 (mm) (138)	5 1/2 (138)	5 1/2 (138)	5 1/2 (138)	6 1/2 (166)	6 1/2 (166)	6 1/2 (166)

Vitorond 100 with Vitotronic Control

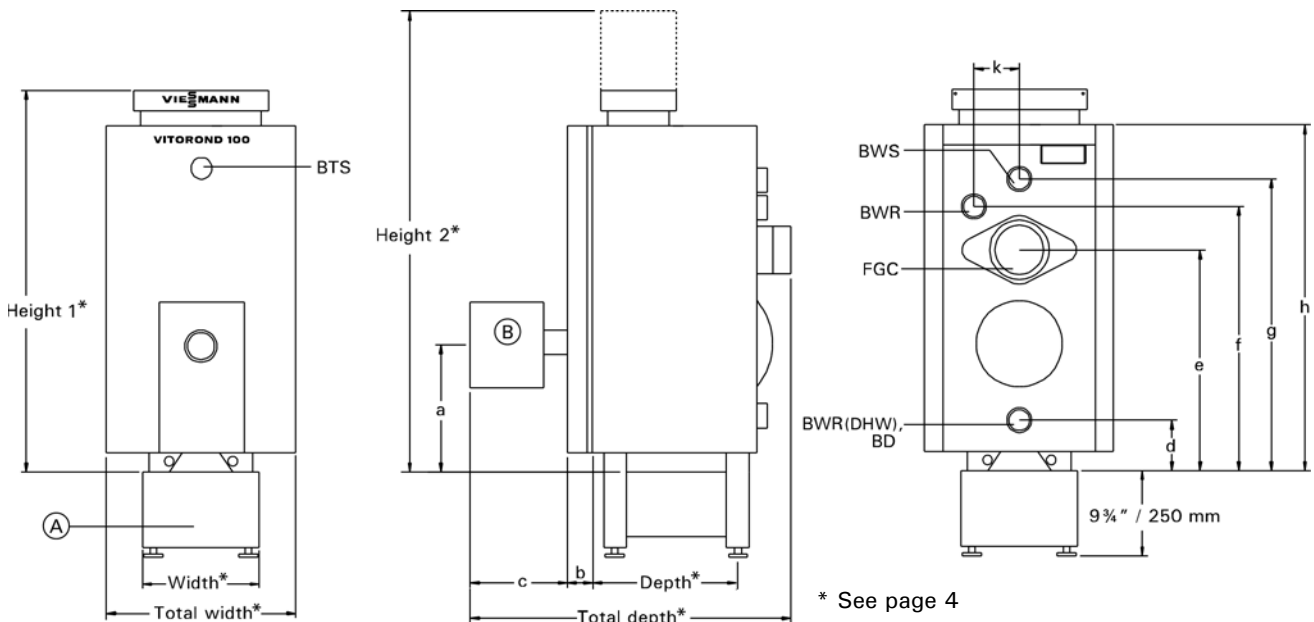

* See page 4

Clearances

Minimum Clearances to Combustibles

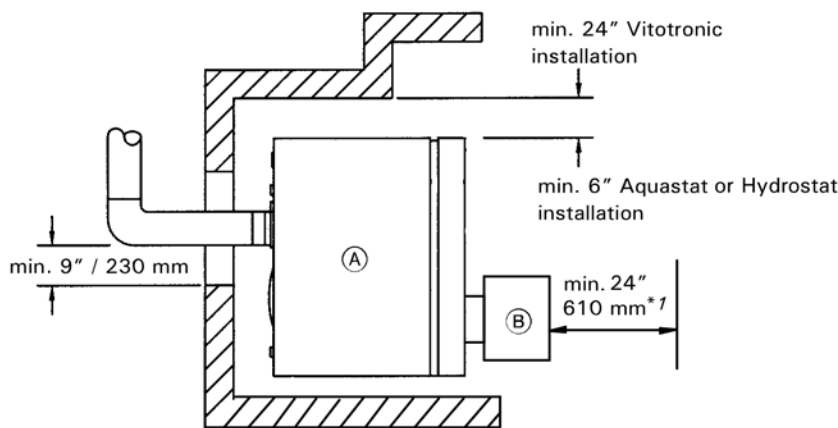
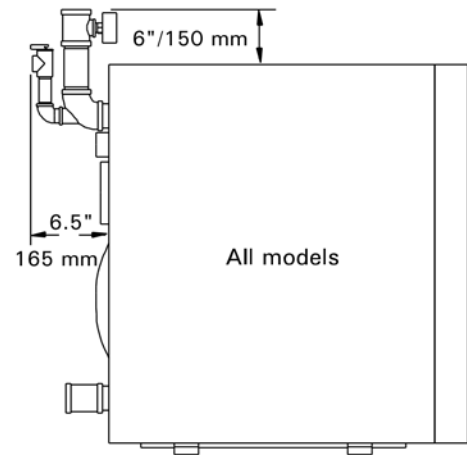
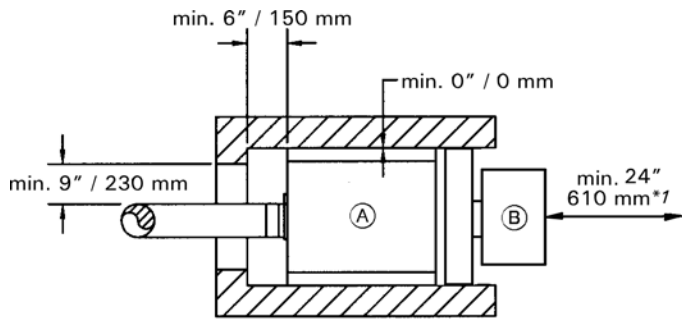

Standard installation

Boiler Model	VR1	22, 91	27, 105	33, 140	40, 161	50, 196	63, 245
Rear	inches (mm)	6 (150)	6 (150)	6 (150)	6 (150)	6 (150)	6 (150)
Sides	inches (mm)	0 (0)	0 (0)	0 (0)	0 (0)	0 (0)	0 (0)
Flue	inches (mm)	9 (230)	9 (230)	9 (230)	9 (230)	9 (230)	9 (230)
Floor	Combustibles						

Alcove installation

Boiler Model	VR1	22, 91	27, 105	33, 140	40, 161	50, 196	63, 245
Rear	inches (mm)	6 (150)	6 (150)	6 (150)	6 (150)	6 (150)	6 (150)
Sides	inches (mm)	0 (0)	0 (0)	0 (0)	0 (0)	0 (0)	0 (0)
Flue	inches (mm)	9 (230)	9 (230)	9 (230)	9 (230)	9 (230)	9 (230)
Top*2	inches (mm)	6 (150)	6 (150)	6 (150)	6 (150)	6 (150)	6 (150)
Floor	Combustibles						

*1 Front service clearance.

*2 24" with Vitotronic control.

Dimensions

Beckett burner (chimney and direct vent*1 application)

Boiler Model No.		VR122, 91*	VR1 27, 105*	VR1 33, 140*	VR1 40, 161	VR1 50, 196	VR1 63, 245
Burner model	Beckett	NX-VI 701	NX-VI 702	NX-VI 703	NX-VI 704	AFG-VI 801	AFG-VI 801
Fuel type	oil	No. 2 fuel oil					
Pump pressure	psig (kPa)	175 (1207)	175 (1207)	175 (1207)	175 (1207)	175 (1207)	175 (1207)
Oil nozzle	Danfoss	n.a.	0.60x60°AS	n.a.	0.85x60°AH	n.a.	n.a.
	Delavan	0.50x60°B	n.a.	0.75x60°A/W	0.85x60°A	1.10x45°W	1.35x60°W
	Hago	0.50x60°B	0.60x60°B	n.a.	n.a.	1.10x45°W	1.35x60°B
Oil nozzle flow rate	GPH@psig	0.65@175	0.75@175	1.00@175	1.15@175	1.40@175	1.75@175
Air tube length	inches (mm)	7 (178)	7 (178)	7 (178)	7 (178)	9 (229)	9 (229)
Air tube insertion	inches (mm)	3¼ (83)	3¼ (83)	3⅝ (92)	4⅞ (124)	7¼ (184)	7¼ (184)

*1 Direct vent burners available only for sizes VR1 22, 27, 33, 91, 105, 140

For information regarding direct vent applications, please refer to Direct Vent Systems Installation Instructions.

Riello burner (chimney vent application)

Boiler Model No.		VR1 22, 91*	VR1 27, 105*	VR1 33, 140*	VR1 40, 161	VR1 50, 196	VR1 63, 245
Burner model	Riello 40 Series	F3	F3	F5	F5	F5	F10
Fuel type	oil	No. 2 fuel oil					
Pump pressure	psig (kPa)	175 (1207)	175 (1207)	175 (1207)	175 (1207)	175 (1207)	175 (1207)
Oil nozzle	Danfoss	0.50x60°AS	0.60x60°AS	0.75x60°AS	0.85x60°AH	1.10x60°AH	1.35x60°AH
	Delavan	0.50x60°SS	0.60x60°W	0.75x60°A 0.75x60°W	0.85x60°A 0.85x60°W	1.10x60°A	1.35x60°A 1.35x60°W
	Hago	0.50x60°SS	0.60x60°ES	n.a.	0.85x60°H	1.10x60°H 1.10x60°SS	1.35x45°SS
Oil nozzle flow rate	GPH@psig	0.65@175	0.75@175	1.00@175	1.15@175	1.40@175	1.75@175
Air tube length	inches (mm)	7 (178)	7 (178)	6 ⁵ / ₁₆ (160)	6 ⁵ / ₁₆ (160)	6 ⁵ / ₁₆ (160)	7 (178)
Air tube insertion	inches (mm)	4 ⁵ / ₈ (118)	4 ⁵ / ₈ (118)	4¼ (108)	4¼ (108)	4¼ (108)	4¾ (121)
Turbulator setting		0.0	2.0	0.8	1.0	3.0	2.0
Air gate setting		3.1	3.4	2.9	3.5	3.6	2.8

■ Boiler standard working pressure: 30 psig; maximum working pressure: 45 psig.

■ Wherever possible, vertically vent the boiler with a properly sized chimney which meets all local and national codes.

■ Draft at the breech is typically -0.02 to -0.08 "w.c.

Dimensions *(continued)*

Riello burner (direct vent application)

Boiler Model No.		VR1 22, 91	VR1 27, 105*1	VR1 33, 140
Burner model	Riello 40 Series	BF3	BF3*1	BF5
Fuel type	oil	No. 2 fuel oil		
Pump pressure	psig (kPa)	175 (1207)	175 (1207)	140 (965)
Oil nozzle	Danfoss	n.a.	n.a.	n.a.
	Delavan	0.50x60°SS	0.60x60°W*3	0.85x60°W*2
	Hago	n.a.	n.a.	n.a.
Oil nozzle flow rate	GPH@psig	0.65@175	0.75@175	1.00@140
Air tube length	inches (mm)	7 (178)	7 (178)	6 ⁵ / ₁₆ (160)
Air tube insertion	inches (mm)	4 ⁵ / ₈ (118)	4 ⁵ / ₈ (118)	4 ¹ / ₄ (108)
Turbulator setting		0.0	1.0	1.0
Air gate setting		3.7	5.0	4.0

IMPORTANT

***1** For VR1-27, 105 boiler, replace installed nozzle with nozzle packaged with Riello burner. Riello oil burners are factory set for Vitorond 100, VR1 22, 33, 91 and 105 boilers and should only require minor adjustments. Install appropriate nozzle and set the burner for model VR1 27, 105

***2** Factory-installed nozzle.

***3** Nozzles must be installed by installer.

Boiler control alternatives

Hydrostat control model 3250-Plus

- High Limit
- with low water cut-off

Vitotronic 100, KW10B

enhanced boiler control for modulating temperature heating systems with indoor/outdoor system control

Vitotronic 200, KW2

for multiple temperature heating systems with or without a mixing valve with indoor/outdoor digital boiler and heating system control

Standard Boiler Equipment

Note: Boiler with controls and burners are purchased separately. Please see Price List for details.

- Boiler shell (insulation preinstalled for VR1 22 to 33 and 91 to 140)
- 30 psig pressure relief valve
- Drain valve

The Boiler Stand must be ordered separately.

- Installation fittings
- Tridicator
- Beckett burner c/w Viessmann specified oil nozzle
- Riello burner c/w Viessmann specified oil nozzle

Dimensions *(continued)***Carlin burner (chimney vent application)**

Boiler Model No.		VR1 22, 91	VR1 27, 105*1	VR1 33, 140
Burner model	Carlin	EZ-LF	EZ-1-HP	EZ-1-HP
Fuel type	oil	No. 2 fuel oil		
Pump pressure	psig	170	155	175
Oil nozzle	Danfoss	0.50x60 ⁰ AS	0.60x60 ⁰ AS	0.75x60 ⁰ AS
	Delavan	--	--	--
	Hago	--	--	--
Oil nozzle flow rate	GPH@psig	0.65@170	0.75@155	1.00@175
Air tube length	inches	9	9	9
	mm	(228.6)	(228.6)	(228.6)
Air tube insertion	inches	5	5	5
	mm	(127)	(127)	(127)
Air tube combination		51192	51192	51192
Head setting		0.50	0.60/0.65	0.75
Air setting		35%	0.65	1.15
Fuel pump c/w solenoid valve		SUNTEC	SUNTEC	SUNTEC
Flange (4 hole, black)		51181	51181	51181

Carlin burner (chimney vent application)

Boiler Model No.		VR1 40, 161	VR1 50, 196	VR1 63, 245
Burner model	Carlin	EZ-1-HP	EZ-66	EZ-66
Fuel type	oil	No. 2 fuel oil		
Pump pressure	psig	185	200	140
Oil nozzle	Danfoss	0.85x70 ⁰ AH	1.00x70 ⁰ B	--
	Delavan	--	--	--
	Hago	--	--	1.50x60 ⁰ SS
Oil nozzle flow rate	GPH@psig	1.15@185	1.40@200	1.75@140
Air tube length	inches	9	9	9
	mm	(228.6)	(228.6)	(228.6)
Air tube insertion	inches	5	5	5
	mm	(127)	(127)	(127)
Air tube combination		51192	51193	51193
Head setting		0.75	3.0	6.0
Air setting		35%	0.65	1.15
Fuel pump c/w solenoid valve		SUNTEC	SUNTEC	SUNTEC
Flange (4 hole, black)		51181	51183	51183

Carlin burner (direct vent application)

Boiler Model No.		VR1 22, 91	VR1 27, 105*1	VR1 33, 140
Burner model	Carlin	EZ-LF	EZ-1HP	EZ-1HP
Fuel type	oil	No. 2 fuel oil		
Pump pressure	psig	170	155	175
Oil nozzle	Danfoss	--	--	--
	Delavan	--	0.60 x 60 ⁰ B	--
	Hago	0.50 x 60 ⁰ B DFN	--	0.75 x 60 ⁰ B
Oil nozzle flow rate	GPH@psig	0.65	0.75	1.00
Air tube length	inches	9 (12D)	9 (EZ-1)	9 (EZ-1)
Air tube insertion	inches	5	5	5
Head setting		0.50	0.50	0.75
Air band setting		45%	0.65	1.20
Fuel pump c/w solenoid valve		SUNTEC	SUNTEC	SUNTEC
Flange (4 hole, black)		51181	51181	51181

System Design Considerations

Chimney

For proper operation of the Vitorond boiler, all products of combustion must be safely vented to the outdoors, while ensuring that flue gases do not cool prematurely.

It is critical that the chimney system be properly designed to handle the flue gas temperatures which the Vitorond boiler produces.

Flue gases which cool too quickly and produce condensation lead to damages if the chimney diameter is too large and the chimney system is not well insulated. If a calculated chimney diameter lies between two values, the larger diameter should be selected.

Intermediate section

The intermediate (vertical and horizontal) section of venting between the boiler vent pipe collar and the chimney must be of the identical diameter as the vent connection of the boiler. Use the shortest possible path between the boiler and the chimney. A maximum of two elbows may be installed in the intermediate section. Avoid the use of two level 90° elbows.

The intermediate section must be sealed pressure tight at the boiler vent pipe collar and at the chimney connection. Ensure any test port for combustion values is sealed as well. The chimney connection length between the boiler vent pipe collar and the chimney may be installed with insulation. We recommend consulting a reputable chimney installer for advice in project-specific circumstances. Barometric damper must be used!

Note: Direct Vent exhaust system operates under a positive pressure developed by the burner. Make sure all vent connections and observation ports on the boiler are sealed air tight by tightening screws and using high temperature silicone sealant if necessary.

The vent components must be supplied without any alteration except for the length of the flex pipe which can be cut to the desired length.

Warranty

Our warranty does not cover damages resulting from the following:

- installation or service by unqualified and not licensed personnel
- corrosion caused by flue gas condensation due to low boiler water and/or return water temperatures
- operation with contaminated fill and supplementary feed water

For detailed warranty information, please read warranty sheet supplied with product.

Combustion air supply

The boiler must not be located in areas or rooms where chemicals containing chlorine, bromine, fluorine, or other corrosive chemicals are stored. Examples include refrigerants, bleach, paint, paint thinner, hair spray, cleaning solvents, water softener salt, etc.

The combustion air must not be contaminated with the above mentioned, or other aggressive or corrosive chemicals.

Boiler should never be installed in areas where excessive dust, high humidity, or risk of frost exist. Ensure adequate ventilation and supply of fresh combustion air.

Consult Viessmann with uncertainties in regard to a suitable boiler installation location.

This boiler/burner unit needs clean fresh air for safe operation and must be installed so that there are provisions for adequate combustion and ventilation air.

For oil-fired boilers, use the "Installation Code for Oil Burning Equipment CAN/CSA-B139" (Canada), or NFPA 31 (USA) and/or provisions of local codes.

The sizing methods outlined in the above codes should be used when installing a round duct to supply combustion air from the outside. Observe local jurisdictional requirements.

System layout

The boiler water temperature limit is factory set to 167° F (75° C) (VitoTronic only).

The boiler water temperature limit can be increased by altering the adjustable high limit to increase the supply water temperature.

To minimize piping losses of the system however, we recommend that the radiation and domestic hot water production in the system be designed for a 158° F (70° C) boiler supply water temperature (new systems).

System Design Considerations *(continued)*

Water quality

Treatment for boiler feed water should be considered in areas of known problems, such as where a high mineral content and hardness exist. In areas where freezing might occur, an antifreeze may be added to the system water to protect the system. Please adhere to the specifications given by the antifreeze manufacturer. Do not use automotive silicate based antifreeze. Please observe that an antifreeze/water mixture may require a backflow preventer within the automatic water feed and influence components such as diaphragm expansion tanks, radiation, etc. A 40% antifreeze content will provide freeze-up protection to -10° F (-23° C). Do not use antifreeze other than specifically made for hot water heating systems. System also may contain components which might be negatively affected by antifreeze. Check total system frequently when filled with antifreeze. Advise system operator/ultimate owner that system is filled with a glycol mix. The heating contractor must provide an MSDS (Material Safety Data Sheet) for the antifreeze used to the system operator/ultimate owner.

Oxygen diffusion barrier underfloor tubing

The boiler warranty does not cover leaks resulting from corrosion caused by the use of underfloor plastic tubing without an oxygen diffusion barrier. Such systems must have the non-oxygen diffusion barrier tubing separated from the boiler with a heat exchanger. Viessmann recommends the use of underfloor plastic tubing with an oxygen diffusion barrier.

Low water cut-off

A low water cut-off may be required by local codes. If boiler is installed above the radiation level, a low water cut-off device of approved type must be installed in all instances. An approved type low water cut-off device must be provided by the heating contractor. Do not install an isolation valve between the boiler and the low water cut-off. Hydrostat control model 3250 PLUS is equipped with low water cut-off.

Waterside flow

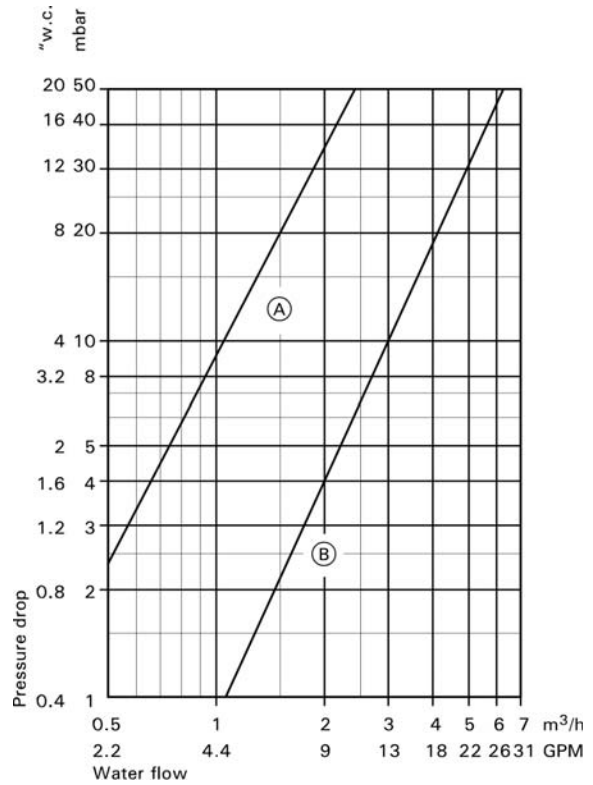

Legend

- Ⓐ VR1 22 to 140
- Ⓑ VR1 40 to 245

Flow rates

The relationship between boiler flow rate and temperature rise is according to the formula:

$$\text{Boiler output (Btu/h)} = 500 \times \text{flow (USGPM)} \times \text{Rise (°F)}$$

The following chart lists typical flow rates for the Vitorond boiler:

Boiler Model	VR1	22, 91	27, 105	33, 140
20° F rise	USGPM	8	9.2	12.2
30° F rise	USGPM	5.3	6.1	8.1

Boiler Model	VR1	40, 161	50, 196	63, 245
20° F rise	USGPM	14	17.2	21.5
30° F rise	USGPM	9.3	11.5	14.3

General

The schematics on the following pages are to be seen as guidelines only. They further do not display all system varieties, safety devices, or concepts possible. Specific system layouts may be further discussed with the local Viessmann sales representative office.

Clearances

A minimum of 2" circumferential clearance from non-insulated hot water pipes to combustible construction must be maintained. In cases where the pipes are insulated with pipe insulation of appropriate and sufficient thickness and insulation values, the above clearance may be reduced to 0".

Installation Examples - Hydrostat

Boiler in a heating/cooling application

Cooling season starts: close valve v1 and open valve v2
 Heating season starts: close valve v2 and open valve v1

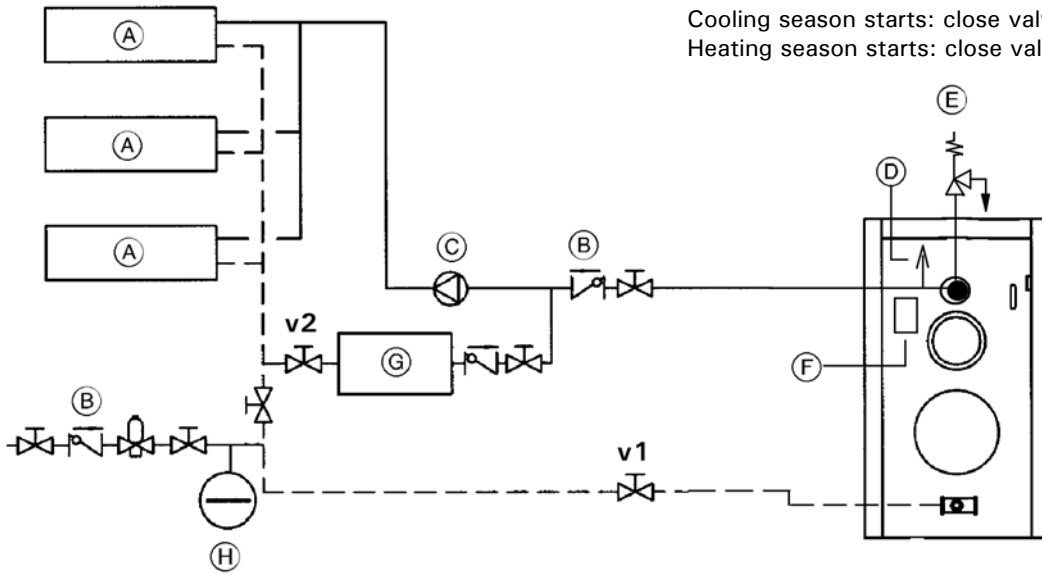

Legend

- (A) Heating/Cooling unit
- (B) Spring-loaded flow check valve
- (C) Circulation pump
- (D) Automatic air vent,
- (E) Pressure relief valve
- (F) Hydrostat 3250-Plus (with low water cut-off)
- (G) Water chiller
- (H) Expansion tank

IMPORTANT

We strongly suggest that the valves be labelled "v1" and v2."

Description

Hydrostat model 3250-Plus is equipped with a low water cut-off feature in combination with 'electro well' sensor well. The function can be set to operate in automatic (default) or manual reset mode. Do not disable this function it may be required by local codes.

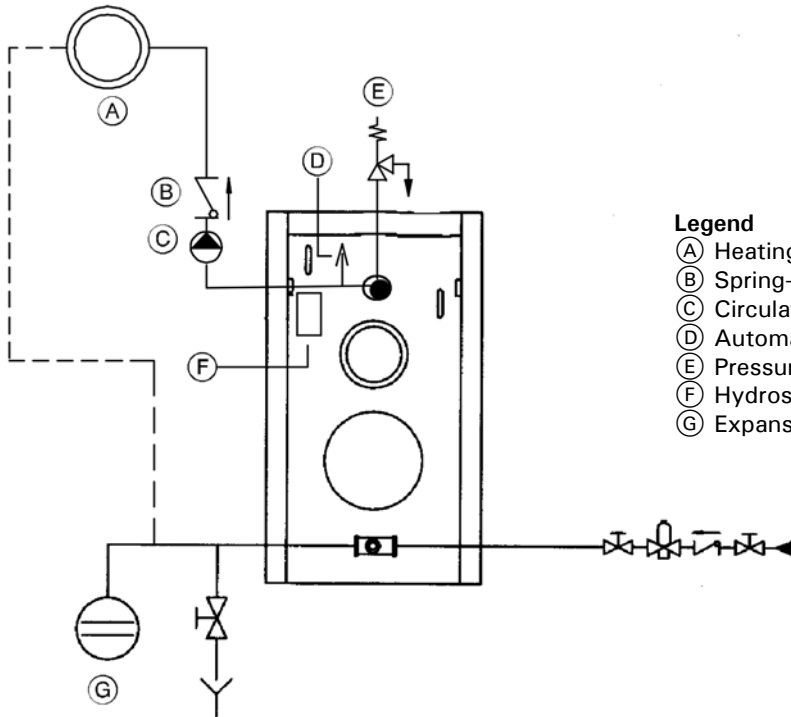

Legend

- (A) Heating circuit
- (B) Spring-loaded flow check valve
- (C) Circulation pump
- (D) Automatic air vent,
- (E) Pressure relief valve
- (F) Hydrostat 3250-Plus (with low water cut-off)
- (G) Expansion tank

Installation Examples - Vitotronic

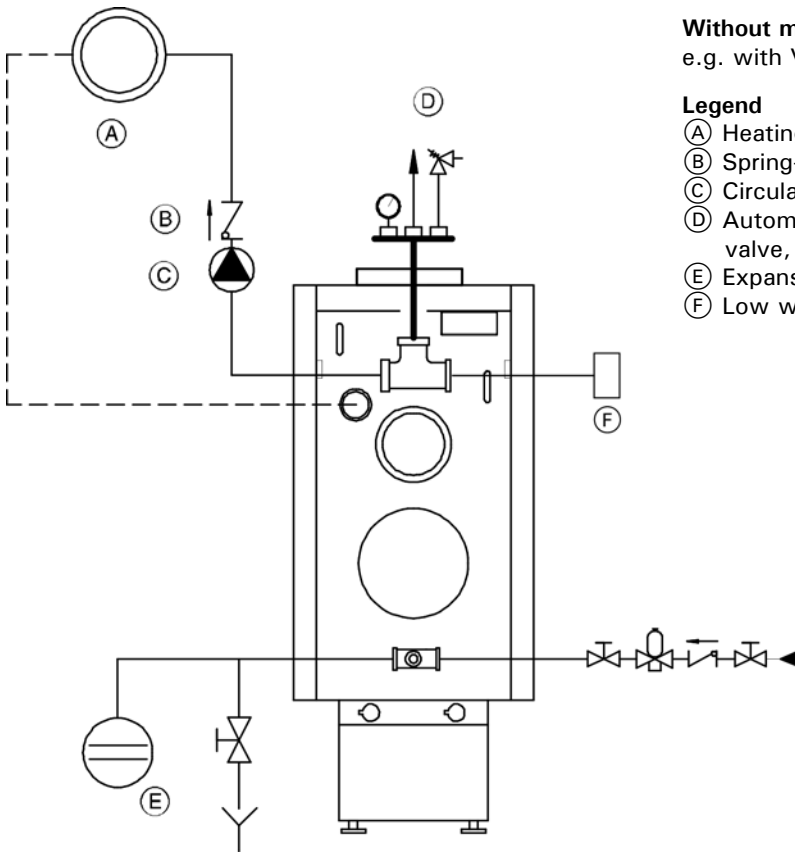

Without mixing valve

e.g. with Vitotronic 100, Model KW10B

Legend

- Ⓐ Heating circuit
- Ⓑ Spring-loaded flow check valve
- Ⓒ Circulation pump
- Ⓓ Automatic air vent, (field supplied), pressure relief valve, and temperature pressure gage
- Ⓔ Expansion tank
- Ⓕ Low water cut-off (if required)

Without mixing valve and with DHW

e.g. with Vitotronic 100, KW10B

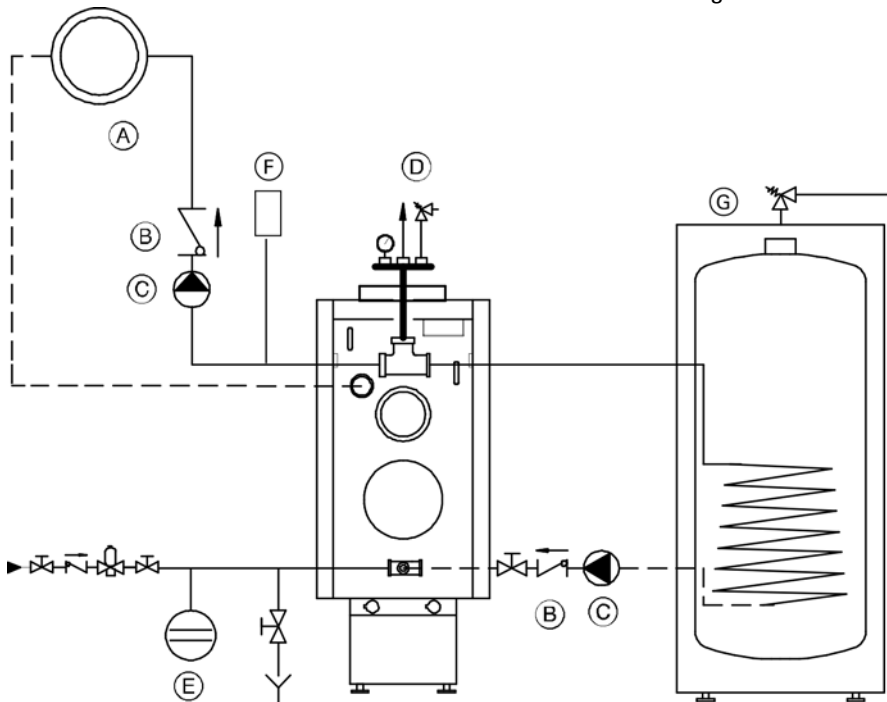

Legend

- Ⓐ Heating circuit
- Ⓑ Spring-loaded flow check valve
- Ⓒ Circulation pump
- Ⓓ Automatic air vent, (field supplied), pressure relief valve, and temperature pressure gage
- Ⓔ Expansion tank
- Ⓕ Domestic hot water storage tank (indirect-fired)
- Ⓖ Low water cut-off (if required)
- Ⓗ DHW storage tank indirect fire

Installation Examples - Vitotronic *(continued)*

With one low-temperature circuit with 4-way mixing valve, and with domestic hot water production.

e.g. with Vitotronic 200, Model KW2 combined with one mixing valve actuator accessory kit

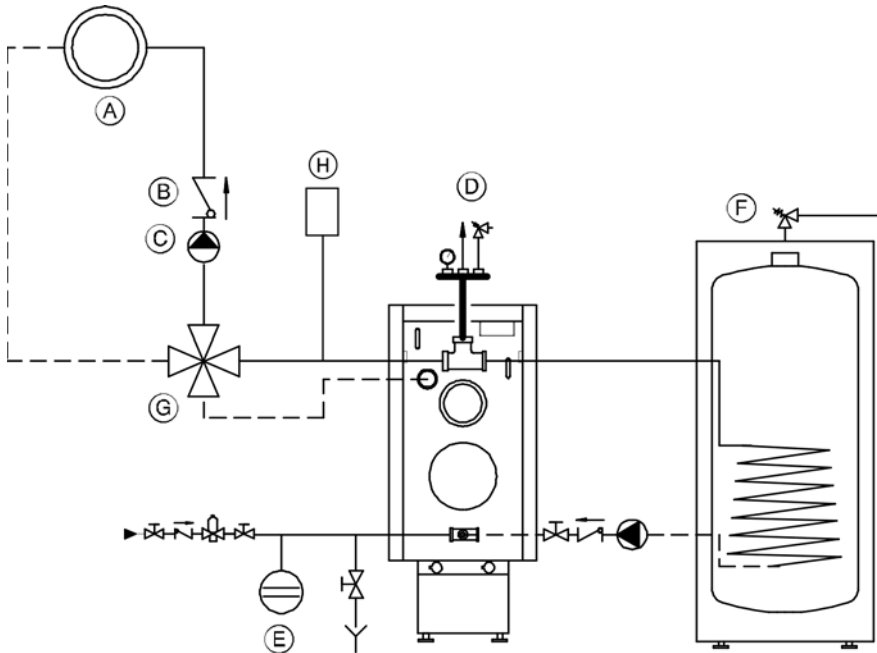

Legend

- Ⓐ Heating circuit
- Ⓑ Spring-loaded flow check valve
- Ⓒ Circulation pump
- Ⓓ Automatic air vent, (field supplied), pressure relief valve, and temperature pressure gage
- Ⓔ Expansion tank
- Ⓕ Domestic hot water storage tank (indirect-fired)
- Ⓖ 4-Way mixing valve
- Ⓗ Low water cut-off (if required)

Installation Examples - Vitotronic *(continued)*

With one low-temperature circuit with 4-way mixing valve, one high temperature circuit, and with domestic hot water production.

e.g. with Vitotronic 200, Model KW2 combined with one mixing valve actuator accessory kit

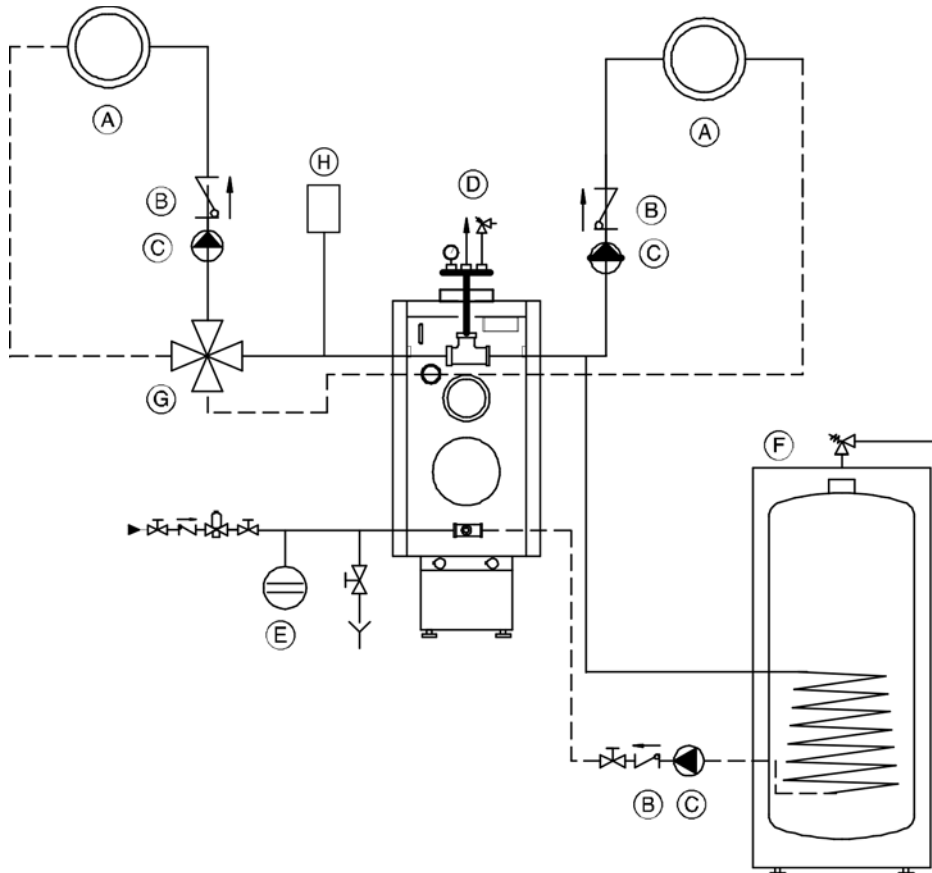

Legend

- (A) Heating circuit
- (B) Spring-loaded flow check valve
- (C) Circulation pump
- (D) Automatic air vent, (field supplied),
pressure relief valve, and temperature pressure gage
- (E) Expansion tank
- (F) Domestic hot water storage tank (indirect-fired)
- (G) 4-Way mixing valve
- (H) Low water cut-off (if required)

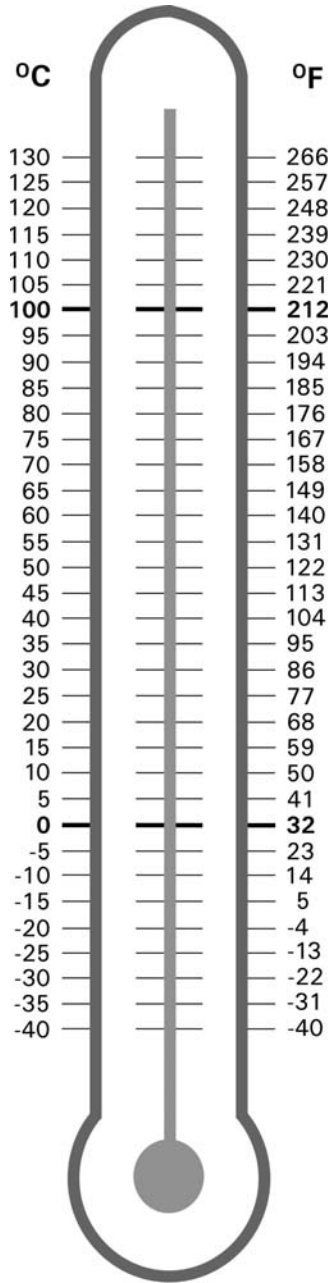

Printed on environmentally friendly
(recycled and recyclable) paper.



Technical information subject to change without notice.

Viessmann Manufacturing Company Inc.
750 McMurray Road
Waterloo, Ontario • N2V 2G5 • Canada
TechInfo Line 1-888-484-8643
1-800-387-7373 • Fax (519) 885-0887
www.viessmann.ca • info@viessmann.ca

Viessmann Manufacturing Company (U.S.) Inc.
45 Access Road
Warwick, Rhode Island • 02886 • USA
TechInfo Line 1-888-484-8643
1-800-288-0667 • Fax (401) 732-0590
www.viessmann-us.com • info@viessmann-us.com