

Webstone®

a brand of **NIBCO®**

PRODUCT CATALOG



PRO-CONNECT
PRESS

PRO-CONNECT
PPR PRO

PRO-CONNECT
PRO PUSH

HYDRO-CORE

The ISOLATOR
UNI-FLANGE BALL VALVE

PRO-PAL
SERIES

The ISOLATOR
E·X·P
TWH SERVICE VALVES

THERMOSTATIC
MIXING VALVES

AIR
SEPARATOR

BALL VALVES

VALVE INNOVATION
GUARANTEED FOR LIFE

Effective January 01, 2018 – Supersedes WBSV-0117 & WBSF-0117

Prices and MTO status are subject to change without notice. Visit our website for the most current information.

THE WEB WARRANTY • PRODUCTS BUILT TO LAST A LIFETIME

Webstone, a brand of NIBCO warrants all of its products to be free from manufacturer defects in material and/or workmanship for the life of the product, provided they are professionally installed and operated under normal conditions. Webstone will replace, FREE OF CHARGE, any product or part thereof that proves defective in material and/or workmanship under normal installation, use, and service.

FOR FULL DETAILS CONTACT WEBSTONE, A BRAND OF NIBCO (800) 225-9529

WEB TRACK SYSTEM SAME DAY SHIPPING AND MORE

All orders placed with Webstone are now processed by our automated Web Track System. Upon receipt of your order, the Web Track System processes it for shipment THE SAME DAY (if received by 1:00 PM EST). Upon shipment, Web Track information is transmitted to you via your preference of fax or email. It serves as your invoice and shipping confirmation. This confirmation invoice includes the carrier name, pro or tracking number, quantities shipped, quantities backordered (if any), and your costs. That means:

**NO MORE LONG LEAD TIMES
FOR ORDER SHIPMENT**

**NO MORE CALLING TO CHECK
ON YOUR ORDER STATUS**

**NO MORE WONDERING IF IT
WILL SHIP COMPLETE OR PARTIAL**

And it doesn't stop there, through our website
WWW.WEBSTONEVALVES.COM
you can do MUCH MORE!

PLACE NEW ORDERS

FIND PART NUMBERS

PRINT SPECIFICATION/SUBMITTAL SHEETS

TRACK YOUR SHIPMENT

UPDATE ACCOUNT INFORMATION

PRINT INVOICES

DOWNLOAD CURRENT BROCHURES & CATALOGS

**AND CONTACT US FOR ANY SPECIAL
ASSISTANCE YOU MAY NEED!**

TERMS OF SERVICE

TERMS OF PAYMENT 2% 10th of the following month. Cash discount is calculated on the total amount of the invoice before additions for freight. A 1 1/2% per month service charge will be added to any past due balances.

FREIGHT ALLOWANCE Prepaid freight on orders of \$1500 net or greater to all contiguous US States & Canada or to the nearest Continental US port for all other locations.

MINIMUM ORDER Webstone has no minimum order.

CLAIMS OF SHORTAGE OR VARIANCE Claims of any character must be made within 10 days after receipt of goods. Settlements of any claims are at the discretion of Webstone, a brand of NIBCO

RETURNS Webstone reserves the right to charge a 30% restocking fee on any returned merchandise. Effective January 1, 2016 overstock returns for products that have been discontinued, redesigned, or purchased prior to the last 18 months will no longer be accepted.

ORDER CONFIRMATIONS All orders are subject to acceptance by Webstone, a brand of NIBCO. Prices are subject to change without notice.

STANDARD PACKAGING Typically, shipments are made in case and carton quantities. However, Webstone will ship any quantities ordered.

UPC BARCODING 100% of products will be shipped with barcodes if customer specifies the need.

Third Party Approvals and Standards Organizations



The Canadian Standards Association
www.cga.ca



Universal Plumbing Code Certified by the **International Association of Plumbing & Mechanical Officials**
www.iapmo.org



Unless otherwise designated, lead-free certification (NSF/ANSI 61 & NSF/ANSI 372) was performed by Truesdail Laboratories.
www.truesdail.com

NSF/ANSI 61 Drinking Water System Components Health Effects – a standard for “chemical contaminants and impurities that are indirectly imparted to drinking water from products, components, and materials used in drinking water systems”.

CleanBrass™ Webstone's choice of raw material that contains less than 0.25% surface lead in the wetted areas and meets the NSF 61-G and NSF 372 standards for Lead in Drinking Water System Components.

Note:

Third Party Approval Agencies often can approve products to a wide variety of standards; some of the standards may be under the responsibility of another agency. For example, IAPMO can issue approvals to NSF/ANSI 61 standard, as can UL, CSA, etc.

Pressure Ratings

WOG: Water, Oil & Gaseous service. Indicates the maximum pressure of the valve body. Pressure of the valve may be limited by temperature or other features.

WSP: Working Steam Pressure. Indicates the maximum steam pressure of a valve body. This rating is independent from the WOG rating. Typically the WSP rating is lower than the WOG rating.

| | |
|---|--------------|
| PRO-CONNECT PRESS™ | 4-5 |
| Air Separator | 4 |
| Ball Valve | 4 |
| Hydro-Core™ | 5 |
| Pro-Pal® Ball Drain™ | 5 |
| Pro-Pal® Purge & Fill™ | 5 |
| Pro-Pal® Purge-Tee™ | 5 |
| Pro-Pal® T-Drain™ | 5 |
| Pro-Pal® Union Ball Drain™ | 5 |
| The Isolator® E-X-P E2™ Tankless Water Heater Service Valve Kit | 5 |
| The Isolator® E-X-P E2™ Wall Hung & Combi Boiler Service Valve Kits | 5 |
| The Isolator® Select | 4 |
| The Isolator® w/ Rotating Flange | 4 |
| The Isolator® w/ Rotating Flange & Multi-Function Drain | 4 |
| The Isolator® w/ Round Flange | 4 |
| Thermostatic Mixing Valve | 4 |
| PRO-CONNECT PP-R PRO™ | 6-7 |
| Ball Valve | 6-7 |
| Pro-Pal® Ball Drain™ | 6-7 |
| Stem Extension Kit | 6-7 |
| The Isolator® w/ Rotating Flange | 6-7 |
| The Isolator® w/ Rotating Flange & Multi-Function Drain | 6-7 |
| PRO-CONNECT PROPUSH™ | 8-9 |
| Fittings | 9 |
| Kits | 8-9 |
| Tools & Accessories | 8 |
| Valves | 8 |
| HYDRO-CORE™ | 10-11 |
| Near Boiler Piping Solutions | 10-11 |
| Secondary Circuit Loop Solutions | 10 |
| THE ISOLATOR® | 12-13 |
| Circulator Pump Installation Kit | 12 |
| Double Flanged Check | 13 |
| Select | 13 |
| Uni-Flange Ball Valve | 12 |
| w/ Drain | 12 |
| w/ Rotating Flange | 12 |
| w/ Rotating Flange & Multi-Function Drain | 12 |
| w/ Round Flange | 13 |
| PRO-PAL® SERIES | 14-15 |
| Ball Drain™ | 14 |
| Expansion Tank Pro Service Valve™ | 15 |
| Purge & Fill™ | 15 |
| Purge-Tee™ | 15 |
| T-Drain™ | 15 |
| Union Ball Drain™ | 14 |
| THE ISOLATOR® E-X-P™ | 16-17 |
| Accessories | 17 |
| Complete Tankless Water Heater Service Valve Kit | 17 |
| E-X-P™ | 16 |
| E2™ | 16 |
| E3™ | 16 |
| Wall Hung & Combi Boiler Service Valve Kit | 17 |
| THERMOSTATIC MIXING VALVES | 18 |
| Thermostatic Mixing Valve | 18 |
| Thermostatic Mixing Valve w/ Integral Check Valve | 18 |
| AIR SEPARATOR | 19 |
| VALVE ACCESSORIES | 19 |
| Add-a-Gauge Tool | 19 |
| Bronze Wye Strainer | 19 |
| Pressure Gauge | 19 |
| BALL VALVES | 20-22 |
| Brass Ball Valves | 20-21 |
| Gas Ball Valves | 22 |
| Mini Ball Valves | 22 |
| PVC & CPVC Ball Valves | 22 |
| Specialty Ball Valves | 20-21 |
| Stainless Steel Ball Valves | 22 |
| PEX | 23 |
| Ball Valve | 23 |
| Mini Ball Valve | 23 |
| Sillcock | 23 |
| Thermostatic Mixing Valve | 23 |
| LOW PRESSURE VALVES | 24-26 |
| Boiler Drains | 24 |
| Check Valves | 25 |
| Gate Valves | 25 |
| Globe Valves | 25 |
| Hose Bibbs | 26 |
| Radiator Valves | 24 |
| Sillcocks | 26 |
| Supply Stops | 26 |
| Unions | 26 |
| INDEX | 27-28 |

- Save time, save space, & save labor
- Compatible with popular press tools

EXCLUSIVE WEBSTONE PRODUCTS NOW WITH PRESS CONNECTIONS

PATENTED TECHNOLOGY WITH FURTHER PATENTS PENDING



The ISOLATOR
UNI-FLANGE BALL VALVE



PRO-CONNECT PRESS THE ISOLATOR W/ ROTATING FLANGE

Full Port Forged Brass Uni-Flange Ball Valve w/ Detachable Rotating Flange, Adjustable Packing Gland, Nuts & Bolts

| STANDARD BRASS | | | |
|--|-----------|----------|------------|
| SIZE | ITEM # | CTN/CASE | LIST PRICE |
| Press × Rotating Flange 250 CWP/250 F Max | | | |
| 3/4" | H-81403HV | 1/20 | \$32.31 |
| 1" | H-81404HV | 1/20 | \$39.03 |
| 1 1/4" | H-81405HV | 1/20 | \$48.81 |
| 1 1/2" | H-81406HV | 1/10 | \$63.78 |
| 2" | H-81407HV | 1/10 | \$97.46 |

W/ MULTI-FUNCTION HI-FLOW HOSE DRAIN

| STANDARD BRASS | | | |
|--|-----------|----------|------------|
| SIZE | ITEM # | CTN/CASE | LIST PRICE |
| Press × Rotating Flange 250 CWP/250 F Max | | | |
| 3/4" | H-81413HV | 1/20 | \$45.10 |
| 1" | H-81414HV | 1/20 | \$55.25 |
| 1 1/4" | H-81415HV | 1/10 | \$69.54 |
| 1 1/2" | H-81416HV | 1/10 | \$94.98 |
| 2" | H-81417HV | 1/10 | \$121.50 |

FITS STANDARD AND HIGH VELOCITY PUMPS · 2" ISOLATORS HAVE 1 1/2" PORT



XLC CONNECTION
ON SIZES 2 1/2" - 4"

PRO-CONNECT PRESS FULL PORT FORGED BRASS BALL VALVE

w/ Adjustable Packing Gland

| STANDARD BRASS | | | | LEAD-FREE BRASS | | | |
|--------------------------|---------|----------|------------|----------------------------|----------|------------|-------------------|
| Certified to NSF/ANSI 61 | | | | Certified to NSF/ANSI 61-G | | | |
| SIZE | ITEM # | CTN/CASE | LIST PRICE | ITEM # | CTN/CASE | LIST PRICE | |
| Press | | | | | | | |
| 1/2" | H-81702 | 5/50 | \$21.01 | H-81702W | 5/50 | \$21.97 | 250 CWP/250 F MAX |
| 3/4" | H-81703 | 5/40 | \$25.73 | H-81703W | 5/40 | \$28.39 | |
| 1" | H-81704 | 4/20 | \$39.03 | H-81704W | 4/20 | \$41.56 | |
| 1 1/4" | H-81705 | 5/20 | \$63.08 | H-81705W | 5/20 | \$69.39 | |
| 1 1/2" | H-81706 | 4/16 | \$87.94 | H-81706W | 4/16 | \$96.13 | |
| 2" | H-81707 | 2/8 | \$136.50 | H-81707W | 2/8 | \$147.60 | |
| 2 1/2" | - | - | - | H-81708W | 1/1 | \$281.30 | |
| 3" | - | - | - | H-81709W | 1/1 | \$391.30 | |
| 4" | - | - | - | H-81710W | 1/1 | \$671.00 | |

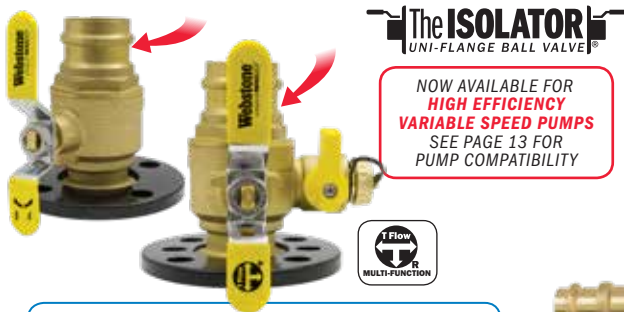

The ISOLATOR
UNI-FLANGE BALL VALVE

NOW AVAILABLE FOR
HIGH EFFICIENCY
VARIABLE SPEED PUMPS
SEE PAGE 13 FOR
PUMP COMPATIBILITY



PRO-CONNECT PRESS THE ISOLATOR W/ ROUND FLANGE

Full Port Forged Brass Uni-Flange Ball Valve w/ Detachable Rotating Flange, Adjustable Packing Gland, Nuts & Bolts

| STANDARD BRASS | | | |
|--|-----------------|----------|------------|
| SIZE | ITEM # | CTN/CASE | LIST PRICE |
| Press × Rotating Flange 250 CWP/250 F Max | | | |
| 1 1/2" | H-81406HV-RF375 | 1/6 | \$93.22 |
| 2" | H-81407HV-RF400 | 1/6 | \$120.20 |
| 2" | H-81407HV-RF475 | 1/6 | \$120.20 |

W/ MULTI-FUNCTION HI-FLOW HOSE DRAIN

| STANDARD BRASS | | | |
|--|-----------------|----------|------------|
| SIZE | ITEM # | CTN/CASE | LIST PRICE |
| Press × Rotating Flange 250 CWP/250 F Max | | | |
| 1 1/2" | H-81416HV-RF375 | 1/6 | \$115.50 |
| 2" | H-81417HV-RF400 | 1/6 | \$142.00 |
| 2" | H-81417HV-RF475 | 1/6 | \$142.00 |



PRO-CONNECT PRESS FULL PORT FORGED BRASS BALL VALVE

w/ Cap & Strap, Reversible Handle & Adjustable Packing Gland

| LEAD-FREE BRASS | | | |
|---------------------------------------|----------|----------|------------|
| Certified to NSF/ANSI 61 & 372 | | | |
| SIZE | ITEM # | CTN/CASE | LIST PRICE |
| Press × Hose 250 CWP/250 F Max | | | |
| 1 1/2" × 3/4" | H-80312W | 5/50 | \$31.95 |
| 3/4" | H-80313W | 5/40 | \$40.67 |



THERMOSTATIC MIXING VALVE

Forged Brass Valve · See Page 18 for application information · Lead-Free

| SIZE | ITEM # | CTN/CASE | LIST PRICE | OUTLET TEMPERATURE RANGE 95-131° F | | | OUTLET TEMPERATURE RANGE 95-120° F | | |
|---|----------|----------|------------|------------------------------------|----------|------------|------------------------------------|----------|------------|
| | | | | ITEM # | CTN/CASE | LIST PRICE | ITEM # | CTN/CASE | LIST PRICE |
| Certified to NSF/ANSI 61 & 372, Body (H-7000W) Certified to ASSE 1017, CSA B125.3 | | | | | | | | | |
| Certified to NSF/ANSI 61 & 372, Body (H-7000W) Certified to ASSE 1017, CSA B125.3 | | | | | | | | | |
| Press | | | | | | | | | |
| 1/2" | H-78102W | 1/10 | \$126.30 | H-78102W-CAN | 1/10 | \$126.30 | 150 PSI | | |
| 3/4" | H-78103W | 1/10 | \$139.80 | H-78103W-CAN | 1/10 | \$139.80 | | | |
| 1" | H-78104W | 1/10 | \$192.60 | H-78104W-CAN | 1/10 | \$192.60 | | | |
| W/ INTEGRAL CHECK VALVE | | | | | | | | | |
| Press | | | | | | | | | |
| 1/2" | H-78202W | 1/10 | \$126.30 | H-78202W-CAN | 1/10 | \$126.30 | 150 PSI | | |
| 3/4" | H-78203W | 1/10 | \$139.80 | H-78203W-CAN | 1/10 | \$139.80 | | | |
| 1" | H-78204W | 1/10 | \$192.60 | H-78204W-CAN | 1/10 | \$192.60 | | | |



IDEAL FOR **GEOTHERMAL**
APPLICATIONS · SEE PAGE 13

THE ISOLATOR SELECT

Full Port Forged Brass Uni-Flange Ball Valve w/ 4-Way Selectable Flow Path, Plugged FNPT Ports, Adjustable Packing Gland, Nuts, Bolts, & Flange Gasket

| STANDARD BRASS | | | |
|--|-----------|----------|------------|
| SIZE | ITEM # | CTN/CASE | LIST PRICE |
| FIP × Press × Rotating Flange 250 CWP/250 F Max | | | |
| 1" | H-81424HV | 1/10 | \$107.20 |

FITS STANDARD & HIGH VELOCITY PUMPS

PRO-CONNECT PRESS FORGED BRASS AIR SEPARATOR

w/ Removable Vent Head & Coalescing Medium

| STANDARD BRASS | | | |
|----------------|---------|----------|------------------|
| SIZE | ITEM # | CTN/CASE | LIST PRICE |
| Press | | | |
| 3/4" | H-78003 | 1/10 | 150 PSI \$102.50 |
| 1" | H-78004 | 1/10 | \$144.20 |
| 1 1/4" | H-78005 | 1/10 | \$202.40 |
| 1 1/2" | H-78006 | 1/10 | \$288.70 |
| 2" | H-78007 | 1/10 | \$345.30 |

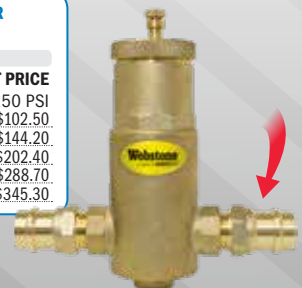

The ISOLATOR.
E-X-P E2
TWH SERVICE VALVES



The ISOLATOR.
E-X-P E2
TWH SERVICE VALVES

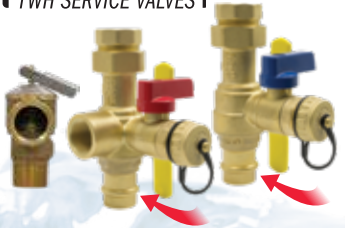

PRO-CONNECT PRESS THE ISOLATOR E-X-P E2 TANKLESS WATER HEATER SERVICE VALVE KIT

Hot & Cold Set of Full Port Forged Brass Ball Valves w/ Hi-Flow Hose Drains, Pressure Relief Valve Outlet & Adjustable Packing Glands

LEAD-FREE BRASS

Certified to NSF/ANSI 61 & 372

SIZE ITEM # CTN/CASE LIST PRICE

INCLUDES RESIDENTIAL PRESSURE RELIEF VALVE (150 PSI/200,000 BTU)

| SIZE | ITEM # | CTN/CASE | LIST PRICE |
|-------------------|------------|-------------------|------------|
| FIP Union x Press | | 250 CWP/250 F Max | |
| 3/4" | H-84443WPR | 1/10 | \$127.50 |
| 1" | H-84444WPR | 1/10 | \$216.40 |

INCLUDES LEAD FREE RESIDENTIAL PRESSURE RELIEF VALVE (150 PSI/200,000 BTU)

| SIZE | ITEM # | CTN/CASE | LIST PRICE |
|-------------------|---------------|-------------------|------------|
| FIP Union x Press | | 250 CWP/250 F Max | |
| 3/4" | H-84443WPR-LF | 1/10 | \$136.80 |
| 1" | H-84444WPR-LF | 1/10 | \$225.70 |

INCLUDES COMMERCIAL GRADE PRESSURE RELIEF VALVE (150 PSI/2.7M BTU) & CLOSE NIPPLE

| SIZE | ITEM # | CTN/CASE | LIST PRICE |
|-------------------|-------------|-------------------|------------|
| FIP Union x Press | | 250 CWP/250 F Max | |
| 3/4" | H-84443WPR2 | 1/10 | \$184.80 |
| 1" | H-84444WPR2 | 1/10 | \$273.70 |

PRO-CONNECT PRESS THE ISOLATOR E-X-P E2 WALL HUNG & COMBI BOILER SERVICE VALVE KIT

Hot & Cold Set of Full Port Forged Brass Ball Valves w/ Hi-Flow Hose Drains, Pressure Relief Valve Outlet & Adjustable Packing Glands - Includes Residential Pressure Relief Valve (30 PSI/510,000 BTU)

LEAD-FREE BRASS

Certified to NSF/ANSI 61 & 372

SIZE ITEM # CTN/CASE LIST PRICE

| SIZE | ITEM # | CTN/CASE | LIST PRICE |
|-------------------|-------------|-------------------|------------|
| FIP Union x Press | | 250 CWP/250 F Max | |
| 3/4" | H-84443WPR3 | 1/10 | \$137.90 |
| 1" | H-84444WPR3 | 1/10 | \$226.80 |

PAIR W/ E-X-P TWH KITS FOR COMBI BOILER DOMESTIC HOT WATER CONNECTIONS

HYDRO-CORE™

COMPLETE NEAR BOILER PIPING KITS



FIND THE RIGHT KIT FOR YOUR BOILER AT WWW.WEBSTONEVALVES.COM/HYDROCORE

INSTALLATION KITS AVAILABLE TO FIT OVER 300 BOILERS FROM 25 DIFFERENT MANUFACTURERS

PRO-PAL SERIES

NEW! SAVE EVEN MORE TIME AND MONEY.

MOST PRO-PAL ITEMS NOW AVAILABLE WITH PRESS CONNECTIONS. SEE PAGE 14-15 FOR MORE DETAILS

BALL DRAIN

Full Port Forged Brass Ball Valve w/ Hi-Flow Hose Drain, Reversible Handle & Adjustable Packing Glands

STANDARD BRASS

| SIZE | ITEM # | CTN/CASE | LIST PRICE |
|-------------|---------|----------|------------|
| Press | | | |
| 1/2" | H-80612 | 4/40 | \$25.70 |
| 3/4" | H-80613 | 4/32 | \$38.40 |
| 1" | H-80614 | 2/20 | \$58.89 |
| 1 1/4" | H-80615 | 2/16 | \$92.21 |
| 1 1/2" | - | - | - |
| 2" | - | - | - |
| Press x FIP | | | |
| 3/4" | H-84613 | 4/32 | \$33.06 |
| 1" | H-84614 | 2/20 | \$51.31 |

LEAD-FREE BRASS

Certified to NSF/ANSI 61 & 372

| SIZE | ITEM # | CTN/CASE | LIST PRICE |
|--------|----------|-------------------|------------|
| Press | | 250 CWP/250 F Max | |
| 1/2" | H-80612W | 4/40 | \$30.82 |
| 3/4" | H-80613W | 4/32 | \$46.70 |
| 1" | H-80614W | 2/20 | \$77.46 |
| 1 1/4" | H-80615W | 2/16 | \$125.70 |
| 1 1/2" | H-80616W | 1/8 | \$179.30 |
| 2" | H-80617W | 1/6 | \$249.80 |

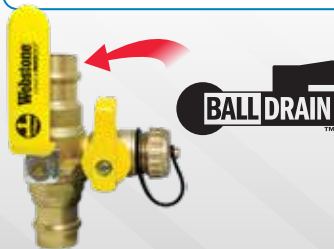

BALL DRAIN™

T DRAIN™



T-DRAIN

Full Port Forged Brass Fitting w/ Hi-Flow Hose Drain & Adjustable Packing Gland

LEAD-FREE BRASS

Certified to NSF/ANSI 61 & 372

| SIZE | ITEM # | CTN/CASE | LIST PRICE |
|--------|----------|-------------------|------------|
| Press | | 250 CWP/250 F Max | |
| 1/2" | H-80672W | 4/40 | \$25.18 |
| 3/4" | H-80673W | 4/16 | \$41.56 |
| 1" | H-80674W | 4/16 | \$59.39 |
| 1 1/4" | H-80675W | 4/16 | \$107.70 |

PURGE & FILL

Full Port Forged Brass Ball Valve w/ (2) Hi-Flow Hose Drains, Reversible Handle & Adjustable Packing Glands

STANDARD BRASS

| SIZE | ITEM # | CTN/CASE | LIST PRICE |
|--------|---------|-------------------|------------|
| Press | | 250 CWP/250 F Max | |
| 3/4" | H-88613 | 1/12 | \$61.45 |
| 1" | H-88614 | 1/12 | \$89.43 |
| 1 1/4" | H-88615 | 1/12 | \$148.30 |
| 1 1/2" | H-88616 | 1/6 | \$203.40 |

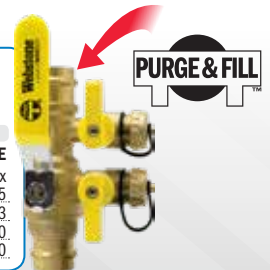

PURGE & FILL™

UNION BALL DRAIN

Full Port Forged Brass Ball Valve w/ Single Union End, Hi-Flow Hose Drain, Reversible Handle & Adjustable Packing Glands

LEAD-FREE BRASS

Certified to NSF/ANSI 61 & 372

| SIZE | ITEM # | CTN/CASE | LIST PRICE |
|-------------------|----------|-------------------|------------|
| Press x FIP Union | | 250 CWP/250 F Max | |
| 3/4" | H-80433W | 4/16 | \$57.92 |
| 1" | H-80434W | 2/16 | \$84.02 |
| 1 1/4" | H-80435W | 2/8 | \$131.00 |
| 1 1/2" | H-80436W | 1/5 | \$175.80 |



UNION BALL DRAIN™

PURGE-TEE

Full Port Forged Brass Ball Valve w/ Reversible Handle & Adjustable Packing Gland

STANDARD BRASS

| SIZE | ITEM # | CTN/CASE | LIST PRICE |
|-----------------|---------|-------------------|------------|
| Press | | 250 CWP/250 F Max | |
| 1" x 3/4" | H-88643 | 1/12 | \$99.42 |
| 1" x 1" | H-88644 | 1/12 | \$118.40 |
| Press | | 250 CWP/250 F Max | |
| 1 1/4" x 1" | H-88654 | 1/12 | \$188.10 |
| 1 1/4" x 1 1/4" | H-88655 | 1/12 | \$234.90 |

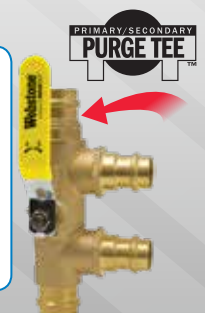

PRIMARY/SECONDARY PURGE TEE™

PRO-CONNECT PP-R PRO™

INNOVATIVE VALVES FOR AQUATHERM PP-R PIPE

PATENTED TECHNOLOGY WITH FURTHER PATENTS PENDING

- Permanent leak-free heat fused connections made in seconds
- Compatible with all Aquatherm PP-R piping systems
- Safe, clean, long-lasting, high performance materials
- Lead Free construction certified to NSF/ANSI 61 & 372
- Suitable for potable applications
- Available in female metric socket nominal sizes 1/2" to 2"
- Saves labor, space & leak paths
- Available exclusively at Aquatherm® dealers



PRO-CONNECT PP-R PRO BALL VALVE
Full Port Forged Brass Ball Valve w/ Adjustable Packing Gland

LEAD-FREE BRASS
Certified to NSF/ANSI 61 & 372

| SIZE | SOCKET I.D. | ITEM# | CTN/CASE | LIST PRICE |
|---|-------------|----------|----------|------------|
| Female PP-R Metric Socket 355 PSI* | | | | |
| 1/2" | 20 mm | H-91702W | 5/50 | \$24.56 |
| 3/4" | 25 mm | H-91703W | 5/40 | \$35.49 |
| 1" | 32 mm | H-91704W | 4/20 | \$54.41 |
| 1 1/4" | 40 mm | H-91705W | 5/20 | \$85.50 |
| 1 1/2" | 50 mm | H-91706W | 4/16 | \$123.60 |
| 2" | 63 mm | H-91707W | 2/8 | \$180.50 |
| Female PP-R Metric Socket x FIP 355 PSI* | | | | |
| 1/2" | 20 mm | H-94702W | 5/50 | \$24.56 |
| 3/4" | 25 mm | H-94703W | 5/40 | \$35.49 |
| 1" | 32 mm | H-94704W | 4/20 | \$54.41 |
| 1 1/4" | 40 mm | H-94705W | 5/20 | \$85.50 |
| 1 1/2" | 50 mm | H-94706W | 4/16 | \$123.60 |
| 2" | 63 mm | H-94707W | 2/8 | \$180.50 |



PRO-CONNECT PP-R PRO THE ISOLATOR W/ ROTATING FLANGE & MULTI-FUNCTION DRAIN
Full Port Forged Brass Uni-Flange Ball Valve w/ Detachable Rotating Flange, Multi-Function Hi-Flow Hose Drain, Adjustable Packing Glands, Nuts & Bolts

LEAD-FREE BRASS
Certified to NSF/ANSI 61 & 372

| SIZE | SOCKET I.D. | ITEM# | CTN/CASE | LIST PRICE |
|---|-------------|------------|----------|------------|
| Female PP-R Metric Socket x Rotating Flange 355 PSI* | | | | |
| 3/4" | 25 mm | H-91413WHV | 1/20 | \$60.35 |
| 1" | 32 mm | H-91414WHV | 1/20 | \$74.85 |
| 1 1/4" | 40 mm | H-91415WHV | 1/10 | \$106.60 |
| 1 1/2" | 50 mm | H-91416WHV | 1/10 | \$140.80 |
| 2" | 63 mm | H-91417WHV | 1/10 | \$171.70 |

2" ISOLATORS HAVE 1 1/2" PORT

PRO-CONNECT PP-R PRO BALL DRAIN
Full Port Forged Brass Ball Valve w/ Hi-Flow Hose Drain, Reversible Handle & Adjustable Packing Glands

LEAD-FREE BRASS
Certified to NSF/ANSI 61 & 372

| SIZE | SOCKET I.D. | ITEM# | CTN/CASE | LIST PRICE |
|---|-------------|----------|----------|------------|
| Female PP-R Metric Socket 355 PSI* | | | | |
| 3/4" | 25 mm | H-90613W | 4/32 | \$45.33 |
| 1" | 32 mm | H-90614W | 2/20 | \$78.18 |
| 1 1/4" | 40 mm | H-90615W | 2/16 | \$114.80 |
| 1 1/2" | 50 mm | H-90616W | 1/8 | \$158.90 |
| 2" | 63 mm | H-90617W | 1/6 | \$229.00 |



STEM EXTENSION KIT

- Replaces existing handle
- Accommodates up to 2" of insulation
- Improves handle accessibility



STEM EXTENSION KIT
For Use with Pro-Connect PP-R Pro Series Valves

| VALVE SIZE | ITEM # | CTN/CASE | LIST PRICE |
|--|------------|----------|------------|
| FITS BALL VALVE (9170 & 9470 SERIES) | | | |
| 1/2" & 3/4" | H-SE-91702 | 12/48 | \$9.83 |
| 1" | H-SE-91704 | 10/40 | \$12.82 |
| 1 1/4" | H-SE-91705 | 8/32 | \$12.82 |
| 1 1/2" | H-SE-91706 | 6/24 | \$21.37 |
| 2" | H-SE-91707 | 6/24 | \$21.37 |
| FITS ISOLATOR W/ ROTATING FLANGE (9140 SERIES) AND BALL DRAIN (9061 SERIES) | | | |
| 3/4" | H-SE-91702 | 12/48 | \$9.83 |
| 1" | H-SE-91704 | 10/40 | \$12.82 |
| 1 1/4" | H-SE-91705 | 8/32 | \$12.82 |
| 1 1/2" & 2" | H-SE-91706 | 6/24 | \$21.37 |
| FITS ISOLATOR W/ ROTATING FLANGE & MULTI-FUNCTION DRAIN (9141 SERIES) | | | |
| 3/4" | H-SE-91413 | 12/48 | \$9.83 |
| 1" | H-SE-91414 | 10/40 | \$12.82 |
| 1 1/4" | H-SE-91415 | 8/32 | \$12.82 |
| 1 1/2" & 2" | H-SE-91416 | 8/24 | \$21.37 |

PRO-CONNECT PP-R PRO THE ISOLATOR W/ ROTATING FLANGE
Full Port Forged Brass Uni-Flange Ball Valve w/ Detachable Rotating Flange, Adjustable Packing Glands, Nuts & Bolts

LEAD-FREE BRASS
Certified to NSF/ANSI 61 & 372

| SIZE | SOCKET I.D. | ITEM# | CTN/CASE | LIST PRICE |
|---|-------------|------------|----------|------------|
| Female PP-R Metric Socket x Rotating Flange 355 PSI* | | | | |
| 3/4" | 25 mm | H-91403WHV | 1/20 | \$45.71 |
| 1" | 32 mm | H-91404WHV | 1/20 | \$63.53 |
| 1 1/4" | 40 mm | H-91405WHV | 1/20 | \$81.96 |
| 1 1/2" | 50 mm | H-91406WHV | 1/10 | \$112.50 |
| 2" | 63 mm | H-91407WHV | 1/10 | \$144.40 |

2" ISOLATORS HAVE 1 1/2" PORT

*Overall valve pressure rating at 73° F. Further restrictions determined by intended operating conditions and limitations specific to the system design. Maximum pressure rating for seat & body alone is 600 PSI.

PRO-CONNECT PP-R PRO

INNOVATIVE VALVES FOR ANY PP-R PIPE

PATENTED TECHNOLOGY WITH FURTHER PATENTS PENDING

- Permanent leak-free heat fused connections made in seconds
- PP-RCT sockets compatible with all PP-R & PP-RCT piping systems†
- Safe, clean, long-lasting, high performance materials
- Lead Free construction certified to NSF/ANSI 61 & 372
- Suitable for potable applications
- Available in female metric socket nominal sizes 1/2" to 2"
- Saves labor, space & leak paths

The ISOLATOR
UNI-FLANGE BALL VALVE



PRO-CONNECT PP-R PRO THE ISOLATOR W/ ROTATING FLANGE & MULTI-FUNCTION DRAIN

Full Port Forged Brass Uni-Flange Ball Valve w/ Detachable Rotating Flange, Multi-Function Hi-Flow Hose Drain, Adjustable Packing Glands, Nuts & Bolts

LEAD-FREE BRASS

Certified to NSF/ANSI 61 & 372

| SIZE | SOCKET I.D. | ITEM# | CTN/CASE | LIST PRICE |
|---|-------------|-------------|----------|------------|
| Female PP-RCT Metric Socket × Rotating Flange 600 PSI* | | | | |
| 3/4" | 25 mm | H-101413WHV | 1/20 | \$60.35 |
| 1" | 32 mm | H-101414WHV | 1/20 | \$74.85 |
| 1 1/4" | 40 mm | H-101415WHV | 1/10 | \$106.60 |
| 1 1/2" | 50 mm | H-101416WHV | 1/10 | \$140.80 |
| 2" | 63 mm | H-101417WHV | 1/10 | \$171.70 |

2" ISOLATORS HAVE 1 1/2" PORT

The ISOLATOR
UNI-FLANGE BALL VALVE



PRO-CONNECT PP-R PRO THE ISOLATOR W/ ROTATING FLANGE

Full Port Forged Brass Uni-Flange Ball Valve w/ Detachable Rotating Flange, Adjustable Packing Glands, Nuts & Bolts

LEAD-FREE BRASS

Certified to NSF/ANSI 61 & 372

| SIZE | SOCKET I.D. | ITEM# | CTN/CASE | LIST PRICE |
|---|-------------|-------------|----------|------------|
| Female PP-RCT Metric Socket × Rotating Flange 600 PSI* | | | | |
| 3/4" | 25 mm | H-101403WHV | 1/20 | \$45.71 |
| 1" | 32 mm | H-101404WHV | 1/20 | \$63.53 |
| 1 1/4" | 40 mm | H-101405WHV | 1/20 | \$81.96 |
| 1 1/2" | 50 mm | H-101406WHV | 1/10 | \$112.50 |
| 2" | 63 mm | H-101407WHV | 1/10 | \$144.40 |

2" ISOLATORS HAVE 1 1/2" PORT

PRO-CONNECT PP-R PRO BALL VALVE

Full Port Forged Brass Ball Valve w/ Adjustable Packing Gland

LEAD-FREE BRASS

Certified to NSF/ANSI 61 & 372

| SIZE | SOCKET I.D. | ITEM# | CTN/CASE | LIST PRICE |
|---|-------------|-----------|----------|------------|
| Female PP-RCT Metric Socket 600 PSI* | | | | |
| 1/2" | 20 mm | H-101702W | 5/50 | \$24.56 |
| 3/4" | 25 mm | H-101703W | 5/40 | \$35.49 |
| 1" | 32 mm | H-101704W | 4/20 | \$54.41 |
| 1 1/4" | 40 mm | H-101705W | 5/20 | \$85.50 |
| 1 1/2" | 50 mm | H-101706W | 4/16 | \$123.60 |
| 2" | 63 mm | H-101707W | 2/8 | \$180.50 |
| Female PP-RCT Metric Socket × FIP 600 PSI* | | | | |
| 1/2" | 20 mm | H-104702W | 5/50 | \$24.56 |
| 3/4" | 25 mm | H-104703W | 5/40 | \$35.49 |
| 1" | 32 mm | H-104704W | 4/20 | \$54.41 |
| 1 1/4" | 40 mm | H-104705W | 5/20 | \$85.50 |
| 1 1/2" | 50 mm | H-104706W | 4/16 | \$123.60 |
| 2" | 63 mm | H-104707W | 2/8 | \$180.50 |



PRO-PAL
SERIES

BALL DRAIN



PRO-CONNECT PP-R PRO BALL DRAIN

Full Port Forged Brass Ball Valve w/ Hi-Flow Hose Drain, Reversible Handle & Adjustable Packing Glands

LEAD-FREE BRASS

Certified to NSF/ANSI 61 & 372

| SIZE | SOCKET I.D. | ITEM# | CTN/CASE | LIST PRICE |
|---|-------------|-----------|----------|------------|
| Female PP-RCT Metric Socket 600 PSI* | | | | |
| 3/4" | 25 mm | H-100613W | 4/32 | \$45.33 |
| 1" | 32 mm | H-100614W | 2/20 | \$78.18 |
| 1 1/4" | 40 mm | H-100615W | 2/16 | \$114.80 |
| 1 1/2" | 50 mm | H-100616W | 1/8 | \$158.90 |
| 2" | 63 mm | H-100617W | 1/6 | \$229.00 |

STEM EXTENSION KIT

For Use with Pro-Connect PP-R Pro Series Valves

| VALVE SIZE | ITEM # | CTN/CASE | LIST PRICE |
|--|------------|----------|------------|
| FITS BALL VALVE (10170 & 10470 SERIES) | | | |
| 1/2" & 3/4" | H-SE-91702 | 12/48 | \$9.83 |
| 1" | H-SE-91704 | 10/40 | \$12.82 |
| 1 1/4" | H-SE-91705 | 8/32 | \$12.82 |
| 1 1/2" | H-SE-91706 | 6/24 | \$21.37 |
| 2" | H-SE-91707 | 6/24 | \$21.37 |
| FITS ISOLATOR W/ ROTATING FLANGE (10140 SERIES) AND BALL DRAIN (10061 SERIES) | | | |
| 3/4" | H-SE-91702 | 12/48 | \$9.83 |
| 1" | H-SE-91704 | 10/40 | \$12.82 |
| 1 1/4" | H-SE-91705 | 8/32 | \$12.82 |
| 1 1/2" & 2" | H-SE-91706 | 6/24 | \$21.37 |
| FITS ISOLATOR W/ ROTATING FLANGE & MULTI-FUNCTION DRAIN (10141 SERIES) | | | |
| 3/4" | H-SE-91413 | 12/48 | \$9.83 |
| 1" | H-SE-91414 | 10/40 | \$12.82 |
| 1 1/4" | H-SE-91415 | 8/32 | \$12.82 |
| 1 1/2" & 2" | H-SE-91416 | 8/24 | \$21.37 |

STEM EXTENSION KIT

- Replaces existing handle
- Accommodates up to 2" of insulation
- Improves handle accessibility



*Valve seat/body maximum pressure rating at 100° F. Overall valve pressure rating is determined by intended operating conditions and limitations specific to the system design. †In accordance with piping manufacturer's installation and warranty requirements.

PRO-CONNECT PROPUSH BALL VALVE

Full Port Forged Dezincification Resistant Brass w/ Adjustable Packing
Gland · For Connection to Copper, CPVC, or PEX · **Lead-Free**

INDIVIDUALLY PACKED

Certified to NSF/ANSI 61-G,
NSF/ANSI-14, IAPMO/ANSI Z1157

| SIZE | ITEM # | CTN/CASE | LIST PRICE |
|-------------|----------|----------|------------|
| Push | | | |
| 1/2" | H-62702W | 10/100 | \$15.72 |
| 3/4" | H-62703W | 10/100 | \$22.52 |
| 1" | H-62704W | 5/50 | \$35.89 |

BULK PACKED

Certified to NSF/ANSI 61-G,
NSF/ANSI-14, IAPMO/ANSI Z1157

| ITEM # | BOX/CASE | LIST PRICE |
|------------|-------------------|------------|
| | 200 PSI/200 F Max | |
| H-62702W-B | 12/72 | \$15.72 |
| H-62703W-B | 12/48 | \$22.52 |
| H-62704W-B | 6/24 | \$35.89 |



FITTINGS NOW AVAILABLE IN SIZES UP TO 2"



PRO-CONNECT PROPUSH IN-LINE SPRING CHECK VALVE

Forged Dezincification Resistant Brass Fitting · For Connection
to Copper, CPVC or PEX · **Lead-Free**

INDIVIDUALLY PACKED

Certified to NSF/ANSI 61-G,
ASSE 1061

| SIZE | ITEM # | CTN/CASE | LIST PRICE |
|-------------|----------|----------|------------|
| Push | | | |
| 1/2" | | | |
| 3/4" | H-26993W | 12/120 | \$23.18 |
| 1" | | | |

BULK PACKED

Certified to NSF/ANSI 61-G,
ASSE 1061

| ITEM # | BOX/CASE | LIST PRICE |
|------------|-------------------|------------|
| | 200 PSI/200 F Max | |
| H-26992W-B | 6/120 | \$20.39 |
| H-26993W-B | 6/72 | \$23.18 |
| H-26994W-B | 3/45 | \$51.39 |



PRO-CONNECT PROPUSH 1/4 TURN SUPPLY STOP

Chrome Plated Dezincification Resistant Brass · For
Connection to Copper, CPVC or PEX · **Lead-Free**

INDIVIDUALLY PACKED

Certified to NSF/ANSI 61 & 372,
ASSE 1061, ASME A112.18.6/CSA B125.6
& IAPMO/ANSI Z1157

| SIZE | ITEM # | CTN/CASE | LIST PRICE |
|---------------------------|----------|----------|------------|
| ANGLED | | | |
| Push × Compression | | | |
| 1/2" × 1/4" | H-26820W | 20/200 | \$14.00 |
| 1/2" × 3/8" | H-26821W | 20/200 | \$14.00 |

BULK PACKED

Certified to NSF/ANSI 61 & 372,
ASSE 1061, ASME A112.18.6/CSA B125.6
& IAPMO/ANSI Z1157

| ITEM # | BOX/CASE | LIST PRICE |
|------------|----------|------------|
| H-26820W-B | 6/120 | \$14.00 |
| H-26821W-B | 12/120 | \$14.00 |

STRAIGHT

| SIZE | ITEM # | CTN/CASE | LIST PRICE |
|---------------------------|----------|----------|------------|
| Push × Compression | | | |
| 1/2" × 1/4" | H-26920W | 20/200 | \$14.00 |
| 1/2" × 3/8" | H-26921W | 20/200 | \$14.00 |

| ITEM # | BOX/CASE | LIST PRICE |
|------------|----------|------------|
| H-26920W-B | 6/120 | \$14.00 |
| H-26921W-B | 12/120 | \$14.00 |



PRO-CONNECT PROPUSH TAP-A-LINE KIT

Includes: Repair Tee, CTS, Straight Supply
Stop & Removal Tool · **Lead-Free**

BULK PACKED

Certified to NSF/ANSI 61 & 372,
ASSE 1061, ASME A112.18.6/CSA B125.6
& IAPMO/ANSI Z1157

| SIZE | ITEM # | BOX/CASE | LIST PRICE |
|--------------------|---------------|-------------------|------------|
| Push × Push | | 200 PSI/200 F Max | |
| 1/2" × 1/4" | H-26920WKIT-B | 12/72 | \$32.79 |
| 1/2" × 3/8" | H-26921WKIT-B | 12/72 | \$32.79 |
| 3/4" × 1/4" | H-26930WKIT-B | 6/60 | \$44.22 |



PRO-CONNECT PROPUSH FLEXIBLE WATER HEATER CONNECTOR

Braided Stainless Steel · For Connection to Copper, CPVC or PEX · **Lead-Free**

INDIVIDUALLY PACKED

Certified to NSF/ANSI 61-G, ASSE 1061
& ASME A112.18.6/CSA B125.6

| SIZE | ITEM # | CTN/CASE | LIST PRICE |
|--------------------------------|-------------|----------|------------|
| Push × FIP · 12" Length | | | |
| 1/2" × 3/4" | | | |
| 3/4" | H-26033W-12 | 1/50 | \$19.40 |

BULK PACKED

Certified to NSF/ANSI 61-G, ASSE 1061
& ASME A112.18.6/CSA B125.6

| ITEM # | BOX/CASE | LIST PRICE |
|---------------|----------|------------|
| H-26023W-12-B | 12/60 | \$17.12 |
| H-26033W-12-B | 12/48 | \$19.40 |

| SIZE | ITEM # | CTN/CASE | LIST PRICE |
|--------------------------------|-------------|----------|------------|
| Push × FIP · 15" Length | | | |
| 1/2" × 3/4" | | | |
| 3/4" | H-26033W-15 | 1/50 | \$20.87 |

| ITEM # | BOX/CASE | LIST PRICE |
|---------------|----------|------------|
| H-26023W-15-B | 12/60 | \$17.15 |
| H-26033W-15-B | 12/48 | \$20.87 |

| SIZE | ITEM # | CTN/CASE | LIST PRICE |
|--------------------------------|-------------|----------|------------|
| Push × FIP · 18" Length | | | |
| 1/2" × 3/4" | H-26023W-18 | 1/50 | \$17.19 |
| 3/4" | H-26033W-18 | 1/50 | \$21.37 |

| ITEM # | BOX/CASE | LIST PRICE |
|---------------|----------|------------|
| H-26023W-18-B | 12/60 | \$17.19 |
| H-26033W-18-B | 12/36 | \$21.37 |

| SIZE | ITEM # | CTN/CASE | LIST PRICE |
|--------------------------------|-------------|----------|------------|
| Push × FIP · 24" Length | | | |
| 1/2" × 3/4" | | | |
| 3/4" | H-26033W-24 | 1/50 | \$23.18 |

| ITEM # | BOX/CASE | LIST PRICE |
|---------------|----------|------------|
| H-26023W-24-B | 12/60 | \$20.39 |
| H-26033W-24-B | 12/36 | \$23.18 |

INDIVIDUALLY PACKED

Certified to NSF/ANSI 61-G,
ASSE 1061, ASME A112.18.6/
CSA B125.6, IAPMO/ANSI Z1157

| SIZE | ITEM # | CTN/CASE | LIST PRICE |
|---|-------------|----------|------------|
| W/ FULL PORT FORGED BRASS DEZINCIFICATION RESISTANT BRASS BALL VALVE | | | |
| Push × FIP · 18" Length | | | |
| 1/2" × 3/4" | H-62023W-18 | 1/25 | \$32.50 |
| 3/4" | H-62033W-18 | 1/25 | \$37.14 |

BULK PACKED

Certified to NSF/ANSI 61-G,
ASSE 1061, ASME A112.18.6/
CSA B125.6, IAPMO/ANSI Z1157

| ITEM # | BOX/CASE | LIST PRICE |
|---------------|----------|------------|
| H-62023W-18-B | 12/48 | \$32.50 |
| H-62033W-18-B | 12/36 | \$37.14 |



PRO-CONNECT PROPUSH WATER HEATER INSTALLATION KIT

Includes (2) Push × FIP Straight Connectors
& Removal Tool · For Connection to
Copper, CPVC or PEX · **Lead-Free**

INDIVIDUALLY PACKED

Certified to NSF/ANSI 61-G,
ASSE 1061

| SIZE | ITEM # | CTN/CASE | LIST PRICE |
|-------------------|-------------|-------------------|------------|
| Push × FIP | | 200 PSI/200 F Max | |
| 1/2" | H-26223WKIT | 5/50 | \$18.67 |
| 3/4" | H-26203WKIT | 5/50 | \$18.12 |

BULK PACKED

Certified to NSF/ANSI 61-G,
ASSE 1061

| SIZE | ITEM # | BOX/CASE | LIST PRICE |
|-------------------|---------------|-------------------|------------|
| Push × FIP | | 200 PSI/200 F Max | |
| 1/2" × 3/4" | H-26223WKIT-B | 12/72 | \$18.67 |
| 3/4" | H-26203WKIT-B | 12/72 | \$18.12 |

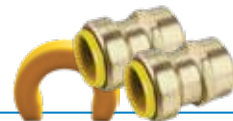

PRO-CONNECT PROPUSH REMOVAL TOOL

INDIVIDUALLY PACKED

| SIZE | ITEM # | CTN/CASE | LIST PRICE |
|------|---------|----------|------------|
| 1/2" | H-28112 | 1/300 | \$1.08 |
| 3/4" | H-28113 | 1/300 | \$1.18 |
| 1" | H-28114 | 1/250 | \$1.47 |

BULK PACKED

| SIZE | ITEM # | BAG/CASE | LIST PRICE |
|--------|-----------|----------|------------|
| 1/4" | H-28110-B | 24/1200 | \$1.08 |
| 3/8" | H-28111-B | 24/1200 | \$1.08 |
| 1/2" | H-28112-B | 24/1200 | \$1.08 |
| 3/4" | H-28113-B | 24/600 | \$1.18 |
| 1" | H-28114-B | 12/600 | \$1.47 |
| 1 1/4" | H-28115-B | 1/50 | \$9.26 |
| 1 1/2" | H-28116-B | 1/50 | \$11.42 |
| 2" | H-28117-B | 1/50 | \$15.42 |

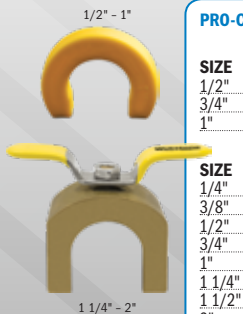

PRO-CONNECT PROPUSH DEBURR & GAUGE TOOL

| SIZE | ITEM # | BAG/CASE | LIST PRICE |
|-----------|-----------|----------|------------|
| 1/4" - 1" | H-28000-B | 1/50 | \$16.31 |

PRO-CONNECT PROPUSH ADAPTER SET

INDIVIDUALLY PACKED

| SIZE | ITEM # | CTN/CASE | LIST PRICE |
|------|---------|----------|------------|
| 1/2" | H-28212 | 1/300 | \$1.10 |
| 3/4" | H-28213 | 1/300 | \$1.23 |
| 1" | H-28214 | 1/250 | \$1.65 |

BULK PACKED

| SIZE | ITEM # | BAG/CASE | LIST PRICE |
|--------|-----------|----------|------------|
| 1/2" | H-28212-B | 1/100 | \$1.10 |
| 3/4" | H-28213-B | 1/100 | \$1.23 |
| 1" | H-28214-B | 1/100 | \$1.65 |
| 1 1/4" | H-28215-B | 1/100 | \$2.55 |
| 1 1/2" | H-28216-B | 1/100 | \$3.36 |
| 2" | H-28217-B | 1/100 | \$4.86 |



PRO PERFORMANCE PUSH CONVENIENCE

PRO-CONNECT PROPUSH STRAIGHT COUPLING

Forged Dezincification Resistant Brass Fitting · For Connection to Copper, CPVC or PEX · **Lead-Free**

INDIVIDUALLY PACKED

Certified to NSF/ANSI 61-G, ASSE 1061

BULK PACKED

Certified to NSF/ANSI 61-G, ASSE 1061

| SIZE | ITEM # | CTN/CASE | LIST PRICE | ITEM # | BAG/CASE | LIST PRICE |
|--------------------------|----------|----------|------------|------------|----------|------------|
| STRAIGHT COUPLING | | | | | | |
| Push | | | | | | |
| 200 PSI/200 F Max | | | | | | |
| 1/4" | - | - | - | H-26100W-B | 6/600 | \$6.86 |
| 1/4" x 1/2" | - | - | - | H-26120W-B | 6/150 | \$8.05 |
| 3/8" | H-26101W | 25/250 | \$7.98 | H-26101W-B | 6/360 | \$7.98 |
| 3/8" x 1/2" | H-26112W | 25/250 | \$8.64 | H-26112W-B | 6/150 | \$8.64 |
| 1/2" | H-26102W | 25/250 | \$8.64 | H-26102W-B | 12/240 | \$8.64 |
| 3/4" | H-26103W | 10/100 | \$9.46 | H-26103W-B | 12/180 | \$9.46 |
| 3/4" x 1/2" | H-26132W | 15/150 | \$11.00 | H-26132W-B | 12/120 | \$11.00 |
| 1" | H-26104W | 9/90 | \$20.27 | H-26104W-B | 6/90 | \$20.27 |
| 1" x 3/4" | H-26143W | 9/90 | \$21.49 | H-26143W-B | 6/90 | \$21.49 |
| 1 1/4" | - | - | - | H-26105W-B | 1/30 | \$43.40 |
| 1 1/4" x 1" | - | - | - | H-26154W-B | 1/30 | \$43.40 |
| 1 1/2" | - | - | - | H-26106W-B | 1/27 | \$63.05 |
| 1 1/2" | - | - | - | H-26165W-B | 1/20 | \$63.05 |
| 2" | - | - | - | H-26107W-B | 1/20 | \$82.24 |
| 2" x 1 1/2" | - | - | - | H-26176W-B | 1/15 | \$82.24 |

FEMALE STRAIGHT CONNECTOR

| SIZE | ITEM # | CTN/CASE | LIST PRICE | ITEM # | BAG/CASE | LIST PRICE |
|-------------------|----------|----------|------------|------------|----------|------------|
| Push x FIP | | | | | | |
| 200 PSI/200 F Max | | | | | | |
| 1/4" x 1/2" | - | - | - | H-26220W-B | 6/180 | \$6.86 |
| 3/8" x 1/2" | - | - | - | H-26212W-B | 6/180 | \$6.86 |
| 1/2" | H-26202W | 20/200 | \$7.00 | H-26202W-B | 12/180 | \$7.00 |
| 1/2" x 3/4" | H-26223W | 20/200 | \$8.75 | H-26223W-B | 6/150 | \$8.75 |
| 3/4" | H-26203W | 12/120 | \$8.75 | H-26203W-B | 6/90 | \$8.75 |
| 3/4" x 1/2" | - | - | - | H-26232W-B | 6/180 | \$8.75 |
| 3/4" x 1" | - | - | - | H-26234W-B | 6/90 | \$19.46 |
| 1" | H-26204W | 9/90 | \$15.96 | H-26204W-B | 6/90 | \$15.96 |
| 1 1/4" | - | - | - | H-26205W-B | 1/30 | \$39.30 |
| 1 1/2" | - | - | - | H-26206W-B | 1/25 | \$62.95 |
| 2" | - | - | - | H-26207W-B | 1/20 | \$74.00 |

MALE STRAIGHT CONNECTOR

| SIZE | ITEM # | CTN/CASE | LIST PRICE | ITEM # | BAG/CASE | LIST PRICE |
|-------------------|----------|----------|------------|------------|----------|------------|
| Push x MIP | | | | | | |
| 200 PSI/200 F Max | | | | | | |
| 1/4" x 1/2" | - | - | - | H-26320W-B | 6/180 | \$6.60 |
| 3/8" x 1/2" | - | - | - | H-26312W-B | 6/180 | \$6.60 |
| 1/2" | H-26302W | 20/200 | \$6.60 | H-26302W-B | 12/180 | \$6.60 |
| 1/2" x 3/4" | H-26323W | 20/200 | \$8.84 | H-26323W-B | 6/120 | \$8.84 |
| 3/4" | H-26303W | 15/150 | \$9.04 | H-26303W-B | 12/120 | \$9.04 |
| 3/4" x 1/2" | - | - | - | H-26332W-B | 6/150 | \$8.84 |
| 3/4" x 1" | - | - | - | H-26334W-B | 6/90 | \$14.36 |
| 1" | H-26304W | 9/90 | \$17.57 | H-26304W-B | 6/90 | \$17.57 |
| 1" x 3/4" | H-26343W | 9/90 | \$14.36 | H-26343W-B | 6/90 | \$14.36 |
| 1 1/4" | - | - | - | H-26305W-B | 1/30 | \$39.30 |
| 1 1/2" | - | - | - | H-26306W-B | 1/25 | \$56.64 |
| 2" | - | - | - | H-26307W-B | 1/20 | \$74.00 |

POLYBUTYLENE ADAPTER

| SIZE | ITEM # | CTN/CASE | LIST PRICE | ITEM # | BAG/CASE | LIST PRICE |
|-----------------------|--------|----------|------------|------------|----------|------------|
| Push x Push PB | | | | | | |
| 200 PSI/200 F Max | | | | | | |
| 1/2" | - | - | - | H-26192W-B | 6/120 | \$11.81 |
| 3/4" | - | - | - | H-26193W-B | 6/90 | \$14.27 |



PRO-CONNECT PROPUSH ELBOW

Forged Dezincification Resistant Brass Fitting · For Connection to Copper, CPVC or PEX · **Lead-Free**

INDIVIDUALLY PACKED

Certified to NSF/ANSI 61-G, ASSE 1061

BULK PACKED

Certified to NSF/ANSI 61-G, ASSE 1061

| SIZE | ITEM # | CTN/CASE | LIST PRICE | ITEM # | BAG/CASE | LIST PRICE |
|-------------------|----------|----------|------------|------------|----------|------------|
| 90° ELBOW | | | | | | |
| Push | | | | | | |
| 200 PSI/200 F Max | | | | | | |
| 1/4" | - | - | - | H-26400W-B | 6/360 | \$7.49 |
| 3/8" | - | - | - | H-26401W-B | 6/180 | \$8.97 |
| 1/2" | H-26402W | 20/200 | \$8.97 | H-26402W-B | 12/180 | \$8.97 |
| 1/2" x 3/8" | - | - | - | H-26421W-B | 12/180 | \$8.97 |
| 3/4" | H-26403W | 12/120 | \$13.21 | H-26403W-B | 12/96 | \$13.21 |
| 3/4" x 1/2" | H-26432W | 12/120 | \$11.92 | H-26432W-B | 6/120 | \$11.92 |
| 1" | H-26404W | 10/100 | \$23.66 | H-26404W-B | 6/60 | \$23.66 |
| 1" x 3/4" | - | - | - | H-26443W-B | 3/60 | \$23.66 |
| 1 1/4" | - | - | - | H-26405W-B | 1/20 | \$47.50 |
| 1 1/2" | - | - | - | H-26406W-B | 1/15 | \$69.44 |
| 2" | - | - | - | H-26407W-B | 1/8 | \$90.46 |
| Push x FIP | | | | | | |
| 1/2" | H-26422W | 20/200 | \$10.46 | H-26422W-B | 6/150 | \$10.46 |
| Push x MIP | | | | | | |
| 200 PSI/200 F Max | | | | | | |
| 1/2" | H-26222W | 20/200 | \$9.70 | H-26222W-B | 6/120 | \$9.70 |
| 3/4" | - | - | - | H-26233W-B | 6/90 | \$13.34 |

90° DROP EAR ELBOW

| SIZE | ITEM # | CTN/CASE | LIST PRICE | ITEM # | BAG/CASE | LIST PRICE |
|-------------------|----------|----------|------------|------------|----------|------------|
| Push x FIP | | | | | | |
| 200 PSI/200 F Max | | | | | | |
| 1/2" | H-26412W | 9/90 | \$10.84 | H-26412W-B | 6/120 | \$10.84 |
| 3/4" | - | - | - | H-26413W-B | 6/90 | \$15.72 |

| SIZE | ITEM # | CTN/CASE | LIST PRICE | ITEM # | BAG/CASE | LIST PRICE |
|-------------------|----------|----------|------------|------------|----------|------------|
| Push | | | | | | |
| 200 PSI/200 F Max | | | | | | |
| 1/2" | H-26462W | 9/90 | \$12.03 | H-26462W-B | 12/120 | \$12.03 |

90° HY-EAR ELBOW

| SIZE | ITEM # | CTN/CASE | LIST PRICE | ITEM # | BAG/CASE | LIST PRICE |
|-------------------|--------|----------|------------|--------------|----------|------------|
| Push x FIP | | | | | | |
| 200 PSI/200 F Max | | | | | | |
| 1/2" | - | - | - | H-26412WHE-B | 6/120 | \$12.65 |



**FREE
CUSTOMIZED
LABELING**
WHEN YOU ORDER 100
UNITS OR MORE

PRO-CONNECT PROPUSH CONTRACTOR PUSH FITTING KIT

27-Piece Assortment of Fittings & Tools · Connection to Copper, CPVC, or PEX

LEAD-FREE BRASS

Certified to NSF/ANSI 61-G, ASSE 1061 & ASME A112.18.6/CSA B125.6

| SIZE | ITEM # | CTN/CASE | LIST PRICE |
|------|-------------|----------|------------|
| KIT | H-26000WKIT | 1/4 | \$197.30 |

PRO-CONNECT PROPUSH END CAP

Forged Dezincification Resistant Brass Fitting · For Connection to Copper, CPVC or PEX · **Lead-Free**

INDIVIDUALLY PACKED

Certified to NSF/ANSI 61-G, ASSE 1061

| SIZE | ITEM # | CTN/CASE | LIST PRICE |
|-------------------|----------|----------|------------|
| Push | | | |
| 200 PSI/200 F Max | | | |
| 1/2" | H-26602W | 30/300 | \$6.51 |
| 3/4" | H-26603W | 20/200 | \$8.97 |
| 1" | H-26604W | 12/120 | \$15.59 |

BULK PACKED

Certified to NSF/ANSI 61-G, ASSE 1061

| SIZE | ITEM # | BAG/CASE | LIST PRICE |
|-------------------|------------|----------|------------|
| Push | | | |
| 200 PSI/200 F Max | | | |
| 3/8" | H-26601W-B | 6/300 | \$6.44 |
| 1/2" | H-26602W-B | 12/300 | \$6.51 |
| 3/4" | H-26603W-B | 6/150 | \$8.97 |
| 1" | H-26604W-B | 6/120 | \$15.59 |
| 1 1/4" | H-26605W-B | 1/40 | \$30.61 |
| 1 1/2" | H-26606W-B | 1/35 | \$43.87 |
| 2" | H-26607W-B | 1/30 | \$57.57 |

PRO-CONNECT PROPUSH SLIP COUPLING

Forged Dezincification Resistant Brass Fitting · For Connection to Copper, CPVC or PEX · **Lead-Free**

INDIVIDUALLY PACKED

Certified to NSF/ANSI 61-G, ASSE 1061

| SIZE | ITEM # | CTN/CASE | LIST PRICE |
|-------------------|----------|----------|------------|
| Push | | | |
| 200 PSI/200 F Max | | | |
| 1/2" | H-26122W | 15/150 | \$15.84 |
| 3/4" | H-26133W | 5/50 | \$20.61 |
| 1" | H-26144W | 5/50 | \$27.64 |

BULK PACKED

Certified to NSF/ANSI 61-G, ASSE 1061

| SIZE | ITEM # | BAG/CASE | LIST PRICE |
|-------------------|------------|----------|------------|
| Push | | | |
| 200 PSI/200 F Max | | | |
| 1/2" | H-26122W-B | 3/90 | \$15.84 |
| 3/4" | H-26133W-B | 3/60 | \$20.61 |
| 1" | H-26144W-B | 1/50 | \$27.64 |



PRO-CONNECT PROPUSH TEE

Forged Dezincification Resistant Brass Fitting · For Connection to Copper, CPVC or PEX · **Lead-Free**

INDIVIDUALLY PACKED

Certified to NSF/ANSI 61-G, ASSE 1061

BULK PACKED

Certified to NSF/ANSI 61-G, ASSE 1061

| SIZE | ITEM # | CTN/CASE | LIST PRICE | ITEM # | BAG/CASE | LIST PRICE |
|--------------------|----------|----------|------------|------------|----------|------------|
| TEE | | | | | | |
| Push | | | | | | |
| 200 PSI/200 F Max | | | | | | |
| 1/4" | - | - | - | H-26500W-B | 6/300 | \$10.20 |
| 3/8" | - | - | - | H-26501W-B | 6/150 | \$13.04 |
| 3/8" x 3/8" x 1/2" | - | - | - | H-26512W-B | 6/120 | \$13.04 |
| 1/2" | H-26502W | 12/120 | \$12.55 | H-26502W-B | 12/120 | \$12.55 |
| 1/2" x 1/2" x 1/4" | - | - | - | H-26520W-B | 6/120 | \$13.04 |
| 1/2" x 1/2" x 3/8" | - | - | - | H-26521W-B | 6/120 | \$13.04 |
| 3/4" | H-26503W | 12/120 | \$17.15 | H-26503W-B | 6/60 | \$17.15 |
| 3/4" x 1/2" x 1/2" | H-26522W | 18/180 | \$15.35 | H-26522W-B | 6/90 | \$15.35 |
| 3/4" x 3/4" x 1/2" | H-26532W | 15/150 | \$15.35 | H-26532W-B | 6/60 | \$15.35 |
| 3/4" x 1/2" x 3/4" | H-26533W | 12/120 | \$16.16 | H-26533W-B | 6/60 | \$16.16 |
| 1" | H-26504W | 6/60 | \$30.56 | H-26504W-B | 3/30 | \$30.56 |
| 1" x 1" x 3/4" | H-26543W | 6/60 | \$30.56 | H-26543W-B | 3/30 | \$30.56 |
| 1 1/4" | - | - | - | H-26505W-B | 1/15 | \$75.60 |
| 1 1/2" | - | - | - | H-26506W-B | 1/10 | \$109.20 |
| 2" | - | - | - | H-26507W-B | 1/6 | \$144.50 |

REPAIR TEE

| SIZE | ITEM # | CTN/CASE | LIST PRICE | ITEM # | BAG/CASE | LIST PRICE |
|-------------------|----------|----------|------------|------------|----------|------------|
| Push | | | | | | |
| 200 PSI/200 F Max | | | | | | |
| 1/2" | H-26702W | 8/80 | \$23.33 | H-26702W-B | 3/90 | \$23.33 |
| 3/4" | H-26703W | 6/60 | \$29.11 | H-26703W-B | 3/60 | \$29.11 |

| SIZE | ITEM # | CTN/CASE | LIST PRICE | ITEM # | BAG/CASE | LIST PRICE |
|--------------------------|----------|----------|------------|------------|----------|------------|
| Push x Push x FIP | | | | | | |
| 200 PSI/200 F Max | | | | | | |
| 1/2" | H-26722W | 8/80 | \$21.57 | H-26722W-B | 3/90 | \$21.57 |
| 3/4" | H-26733W | 6/60 | \$27.64 | H-26733W-B | 3/60 | \$27.64 |

| SIZE | ITEM # | CTN/CASE | LIST PRICE | ITEM # | BAG/CASE | LIST PRICE |
|-------------------------------|--------|----------|------------|------------|----------|------------|
| Push x Push x CTS Slip | | | | | | |
| 200 PSI/200 F Max | | | | | | |
| 1/2" | - | - | - | H-26752W-B | 6/60 | \$21.61 |

HYDRO-CORE™

PATENTED TECHNOLOGY

A REVOLUTIONARY APPROACH TO HYDRONIC INSTALLATIONS

The Webstone Hydro-Core Manifold is the ideal solution for most near boiler piping or secondary loops.

- Combines Webstone Isolator® and Ball Drain™ with closely spaced tees
- Eliminates costly field fabrication
- Avoids precise calculations
- Simplifies future maintenance
- Saves space
- All with EXPERT looking results
- Press, FIP, or SWT system connections

HYDRO-CORE™
UNION CONNECTION



PRO-CONNECT
PRESS

Compatible with popular press tools

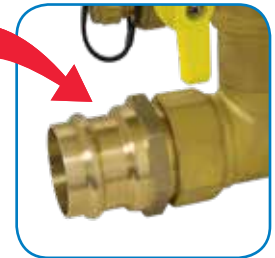

THE OLD WAY

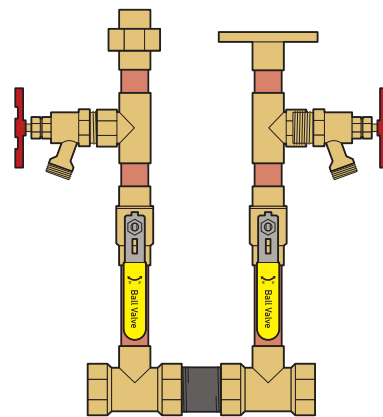

THE WEBSTONE WAY

REPLACES 17 COMPONENTS
ELIMINATES 16 LEAK PATHS
SAVES 144 MINUTES OF LABOR



T-Flow Ball
Directs flow into either the boiler or purge drain

Precision-Crafted Closely Spaced Tees
for hydraulic separation

Fully-Insulated Body

Snug-Fit Rotating Flange



FLANGE OPTIONS



Flange Right



Flange Left



No Flange
Double Ball Drain

ADVANTAGES

Precise Spacing for Hydraulic Separation

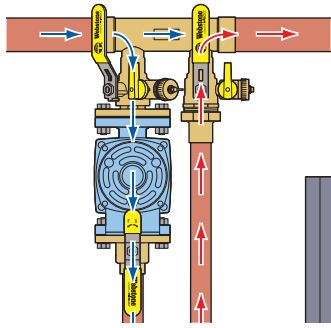

Simplifies Pump Isolation

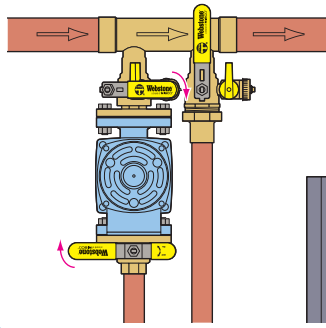

Easily Purge, Fill, or Descale* a Boiler or Secondary Loop

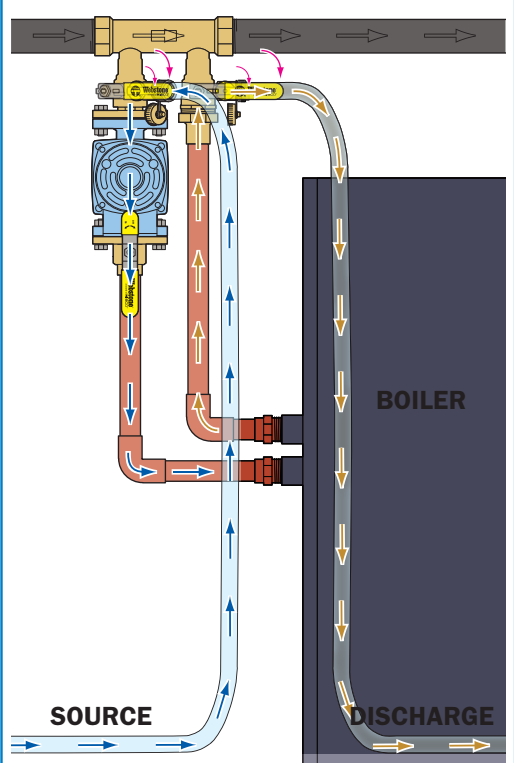

*Descaling may not be recommended for all boilers. Consult boiler manufacturer for details.

Simplifies System Purging Through the Boiler Outside the Boiler

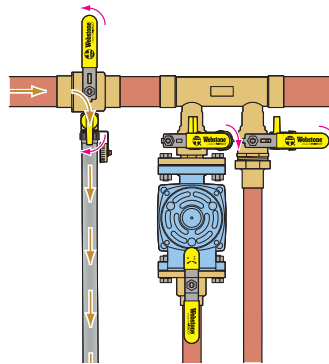
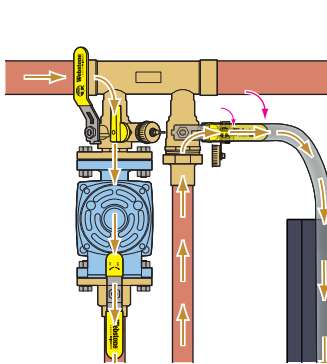

HYDRO-CORE™

COMPLETE NEAR BOILER PIPING KITS

A fully-fabricated solution, kits include everything necessary for a successful installation.

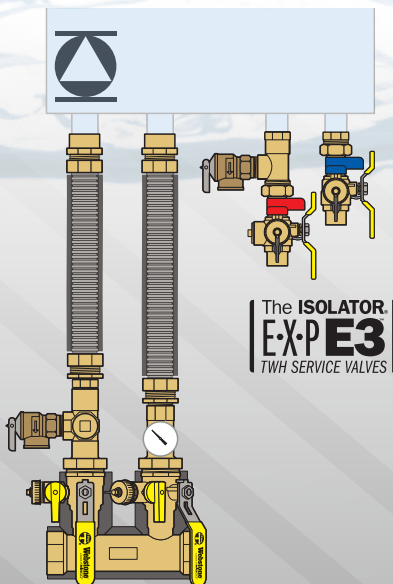

FIND THE RIGHT KIT FOR YOUR BOILER: WEBSTONEVALVES.COM/HYDROCORE FOR FULL COMPATIBILITY INFO

WALL HUNG BOILER KITS†

- Choice of Press, FIP or SWT Hydro-Core Double Ball Drain Manifold
- Insulated manifold, supply & return lines
- Integrated connections for your specific boiler
- Assembled with flexible stainless steel tubing
- Tubing may be cut for installations in close quarters

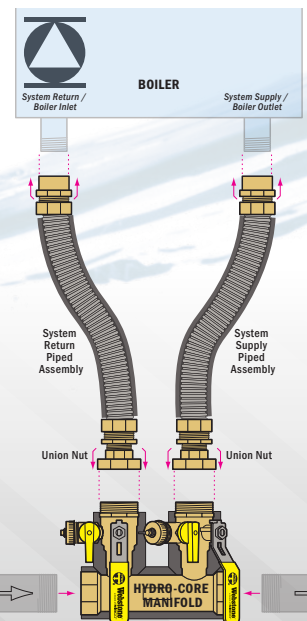

COMBI BOILER KITS†

Includes all the features of the wall hung boiler kits, plus components for DHW connections

- Plugged FIP ports for connection to other devices
- 1/4" pressure gauge port
- 30 PSI pressure gauge
- 30 PSI pressure relief valve for boiler
- 3/4" Isolator E-X-P E3 service valve kit
- 150 PSI pressure relief valve for DHW

† Features may vary by kit.

The ISOLATOR[®]

UNI-FLANGE BALL VALVE[®]

THE ONLY WAY TO ISOLATE CIRCULATOR PUMPS

PATENTED TECHNOLOGY WITH FURTHER PATENTS PENDING

THE OLD WAY

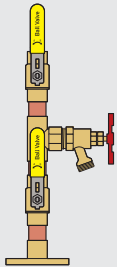

THE WEBSTONE WAY
REPLACES 8 COMPONENTS
ELIMINATES 7 LEAK PATHS
SAVES 63 MINUTES OF LABOR

These valves have revolutionized the installation of circulator pumps. Our original Isolator Uni-Flange Ball Valve design has evolved into the largest flanged ball valve program in the industry today.

- Conical inlet to minimize turbulence
- Slotted holes for high velocity pumps
- Fits virtually any circulator pump



THE ISOLATOR UNI-FLANGE BALL VALVE

Full Port Forged Brass Ball Valve w/ Adjustable Packing Gland, Nuts & Bolts

| STANDARD BRASS | | | | |
|------------------------------|---------|-----------|----------|------------|
| SIZE | ITEM# | HV ITEM# | CTN/CASE | LIST PRICE |
| FIP × Flange 600 WOG | | | | |
| 1/2" | H-40402 | H-40402HV | 1/20 | \$26.65 |
| 3/4" | H-40403 | H-40403HV | 1/20 | \$30.09 |
| 1" | H-40404 | H-40404HV | 1/20 | \$36.27 |
| 1 1/4" | H-40405 | H-40405HV | 1/20 | \$43.14 |
| 1 1/2" | H-40406 | H-40406HV | 1/20 | \$60.79 |
| 2" | - | H-40407HV | 1/10 | \$80.94 |
| SWT × Flange 600 WOG | | | | |
| 1/2" | H-50402 | H-50402HV | 2/20 | \$26.65 |
| 3/4" | H-50403 | H-50403HV | 1/20 | \$30.09 |
| 1" | H-50404 | H-50404HV | 1/20 | \$36.27 |
| 1 1/4" | H-50405 | H-50405HV | 1/20 | \$43.14 |
| 1 1/2" | H-50406 | H-50406HV | 1/20 | \$60.79 |
| 2" | - | H-50407HV | 1/10 | \$80.94 |
| W/ HI-FLOW HOSE DRAIN | | | | |
| FIP × Flange 600 WOG | | | | |
| 3/4" | H-40413 | H-40413HV | 1/20 | \$44.01 |
| 1" | H-40414 | H-40414HV | 1/20 | \$53.42 |
| 1 1/4" | H-40415 | H-40415HV | 1/20 | \$67.37 |
| 1 1/2" | H-40416 | H-40416HV | 1/10 | \$92.25 |
| 2" | - | H-40417HV | 1/10 | \$124.90 |
| SWT × Flange 600 WOG | | | | |
| 3/4" | H-50413 | H-50413HV | 1/20 | \$44.01 |
| 1" | H-50414 | H-50414HV | 1/20 | \$53.42 |
| 1 1/4" | H-50415 | H-50415HV | 1/20 | \$67.37 |
| 1 1/2" | H-50416 | H-50416HV | 1/10 | \$92.25 |
| 2" | - | H-50417HV | 1/10 | \$124.90 |

HV ITEMS FIT HIGH VELOCITY & STANDARD SIZE PUMPS. 2" ISOLATORS HAVE 1 1/2" PORT.

AVAILABLE W/
PRO-CONNECT PPR/PRO
EXCLUSIVELY FOR
aquatherm
SEE PAGE 6

AVAILABLE W/
PRO-CONNECT PPR/PRO
FOR ANY
PP-R OR PP-RCT
PIPING SYSTEM
SEE PAGE 7

PURGES BEFORE OR AFTER PUMP

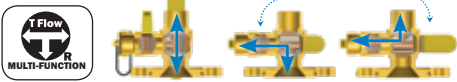

SNUG-FIT ROTATING FLANGE



- Unique uni-body design is preserved
- Solid forged brass outer flange
- Fully removable outer flange secured by snap ring

SECTION REMOVED TO SHOW INTERNAL CONSTRUCTION

THE ISOLATOR W/ ROTATING FLANGE

Full Port Forged Brass Uni-Flange Ball Valve w/ Detachable Rotating Flange, Adjustable Packing Gland, Nuts & Bolts

| STANDARD BRASS | | | | | LEAD-FREE BRASS | | | | |
|--|---------|-----------|----------|------------|-----------------|------------|----------|------------|---|
| SIZE | ITEM# | HV ITEM# | CTN/CASE | LIST PRICE | ITEM# | HV ITEM# | CTN/CASE | LIST PRICE | |
| FIP × Rotating Flange 600 WOG | | | | | | | | | |
| 3/4" | H-41403 | H-41403HV | 1/20 | \$30.39 | H-41403W | H-41403WHV | 2/20 | \$36.67 | |
| 1" | H-41404 | H-41404HV | 1/20 | \$36.63 | H-41404W | H-41404WHV | 2/20 | \$45.18 | |
| 1 1/4" | H-41405 | H-41405HV | 1/20 | \$43.56 | H-41405W | H-41405WHV | 2/20 | \$54.69 | |
| 1 1/2" | H-41406 | H-41406HV | 1/20 | \$61.39 | H-41406W | H-41406WHV | 2/10 | \$75.87 | |
| 2" | - | - | - | - | H-41407W | H-41407WHV | 1/10 | \$83.37 | |
| SWT × Rotating Flange 600 WOG | | | | | | | | | |
| 3/4" | H-51403 | H-51403HV | 1/20 | \$30.39 | H-51403W | H-51403WHV | 2/20 | \$36.67 | |
| 1" | H-51404 | H-51404HV | 1/20 | \$36.63 | H-51404W | H-51404WHV | 2/20 | \$45.18 | |
| 1 1/4" | H-51405 | H-51405HV | 1/20 | \$43.56 | H-51405W | H-51405WHV | 2/20 | \$54.69 | |
| 1 1/2" | H-51406 | H-51406HV | 1/20 | \$61.39 | H-51406W | H-51406WHV | 2/10 | \$75.87 | |
| 2" | - | - | - | - | H-51407W | H-51407WHV | 1/10 | \$83.37 | |
| Press × Rotating Flange 250 CWP/250 F Max | | | | | | | | | |
| 3/4" | - | H-81403HV | 1/20 | \$32.31 | - | - | - | - | - |
| 1" | - | H-81404HV | 1/20 | \$39.03 | - | - | - | - | - |
| 1 1/4" | - | H-81405HV | 1/20 | \$48.81 | - | - | - | - | - |
| 1 1/2" | - | H-81406HV | 1/10 | \$63.78 | - | - | - | - | - |
| 2" | - | H-81407HV | 1/10 | \$97.46 | - | - | - | - | - |
| W/ MULTI-FUNCTION HI-FLOW HOSE DRAIN | | | | | | | | | |
| FIP × Rotating Flange 600 WOG | | | | | | | | | |
| 3/4" | H-41413 | H-41413HV | 2/20 | \$43.18 | H-41413W | H-41413WHV | 2/20 | \$52.33 | |
| 1" | H-41414 | H-41414HV | 2/20 | \$52.41 | H-41414W | H-41414WHV | 2/20 | \$64.41 | |
| 1 1/4" | H-41415 | H-41415HV | 2/20 | \$66.08 | H-41415W | H-41415WHV | 2/10 | \$80.76 | |
| 1 1/2" | H-41416 | H-41416HV | 2/10 | \$90.50 | H-41416W | H-41416WHV | 2/10 | \$110.60 | |
| 2" | - | - | - | - | H-41417W | H-41417WHV | 1/10 | \$122.50 | |
| SWT × Rotating Flange 600 WOG | | | | | | | | | |
| 3/4" | H-51413 | H-51413HV | 2/20 | \$43.18 | H-51413W | H-51413WHV | 2/20 | \$52.33 | |
| 1" | H-51414 | H-51414HV | 2/20 | \$52.41 | H-51414W | H-51414WHV | 2/20 | \$64.41 | |
| 1 1/4" | H-51415 | H-51415HV | 2/20 | \$66.08 | H-51415W | H-51415WHV | 2/10 | \$80.76 | |
| 1 1/2" | H-51416 | H-51416HV | 2/10 | \$90.50 | H-51416W | H-51416WHV | 2/10 | \$110.60 | |
| 2" | - | - | - | - | H-51417W | H-51417WHV | 1/10 | \$122.50 | |
| Press × Rotating Flange 250 CWP/250 F Max | | | | | | | | | |
| 3/4" | - | H-81413HV | 1/20 | \$45.10 | - | - | - | - | - |
| 1" | - | H-81414HV | 1/20 | \$55.25 | - | - | - | - | - |
| 1 1/4" | - | H-81415HV | 1/10 | \$69.54 | - | - | - | - | - |
| 1 1/2" | - | H-81416HV | 1/10 | \$94.98 | - | - | - | - | - |
| 2" | - | H-81417HV | 1/10 | \$121.50 | - | - | - | - | - |

HV ITEMS FIT HIGH VELOCITY & STANDARD SIZE PUMPS. 2" ISOLATORS HAVE 1 1/2" PORT.

THE ISOLATOR CIRCULATOR PUMP INSTALLATION KIT

Your choice of Isolator & Isolator w/ Drain & 2 Full-Faced Flange Gaskets, Nuts & Bolts

| STANDARD BRASS | | | | | LEAD-FREE BRASS | | | | |
|---|------------|--------------|----------|------------|-----------------|---------------|----------|------------|---|
| SIZE | ITEM# | HV ITEM# | CTN/CASE | LIST PRICE | ITEM# | HV ITEM# | CTN/CASE | LIST PRICE | |
| THE ISOLATOR CIRCULATOR PUMP INSTALLATION KIT | | | | | | | | | |
| FIP × Flange 600 WOG | | | | | | | | | |
| 3/4" | H-40413KIT | H-40413HVKIT | 1/10 | \$82.13 | - | - | - | - | - |
| 1" | H-40414KIT | H-40414HVKIT | 1/10 | \$97.71 | - | - | - | - | - |
| 1 1/4" | H-40415KIT | H-40415HVKIT | 1/10 | \$118.50 | - | - | - | - | - |
| SWT × Flange 600 WOG | | | | | | | | | |
| 3/4" | H-50413KIT | H-50413HVKIT | 1/10 | \$82.13 | - | - | - | - | - |
| 1" | H-50414KIT | H-50414HVKIT | 1/10 | \$97.71 | - | - | - | - | - |
| 1 1/4" | H-50415KIT | H-50415HVKIT | 1/10 | \$118.50 | - | - | - | - | - |
| THE ISOLATOR W/ ROTATING FLANGE CIRCULATOR PUMP INSTALLATION KIT | | | | | | | | | |
| FIP × Rotating Flange 600 WOG | | | | | | | | | |
| 3/4" | H-41413KIT | H-41413HVKIT | 1/10 | \$81.82 | H-41413WKIT | H-41413WHVKIT | 1/10 | \$97.26 | |
| 1" | H-41414KIT | H-41414HVKIT | 1/10 | \$97.29 | H-41414WKIT | H-41414WHVKIT | 1/10 | \$117.80 | |
| 1 1/4" | H-41415KIT | H-41415HVKIT | 1/10 | \$117.90 | H-41415WKIT | H-41415WHVKIT | 1/10 | \$143.70 | |
| SWT × Rotating Flange 600 WOG | | | | | | | | | |
| 3/4" | H-51413KIT | H-51413HVKIT | 1/10 | \$81.82 | H-51413WKIT | H-51413WHVKIT | 1/10 | \$97.26 | |
| 1" | H-51414KIT | H-51414HVKIT | 1/10 | \$97.29 | H-51414WKIT | H-51414WHVKIT | 1/10 | \$117.80 | |
| 1 1/4" | H-51415KIT | H-51415HVKIT | 1/10 | \$117.90 | H-51415WKIT | H-51415WHVKIT | 1/10 | \$143.70 | |
| Press × Rotating Flange 250 CWP/250 F Max | | | | | | | | | |
| 3/4" | - | H-81413HVKIT | 1/10 | \$85.68 | - | - | - | - | - |
| 1" | - | H-81414HVKIT | 1/10 | \$102.50 | - | - | - | - | - |
| 1 1/4" | - | H-81415HVKIT | 1/10 | \$126.60 | - | - | - | - | - |

HV ITEMS FIT HIGH VELOCITY & STANDARD SIZE PUMPS. 2" ISOLATORS HAVE 1 1/2" PORT.

NOW FOR HIGH EFFICIENCY VARIABLE SPEED PUMPS

The ISOLATOR[®]

UNI-FLANGE BALL VALVE[®]
with **ROUND FLANGE**

- Detachable rotating round flange
- Three flange styles designed specifically for each pump



AVAILABLE W/
PRO-CONNECT PRESS



THE ISOLATOR DOUBLE FLANGED CHECK

Forged Brass Check Valve w/ Rotating Flange · Includes One Set of Mounting Bolts & Full Faced Flange Gasket

| STANDARD BRASS | | | |
|---------------------------------|-----------|----------|------------|
| SIZE | HV ITEM# | CTN/CASE | LIST PRICE |
| Flange × Rotating Flange | | | |
| 3/4" thru 1 1/4" | H-13703HV | 1/10 | \$32.26 |
| 1 1/2" thru 2" | H-13706HV | 1/10 | \$39.71 |

FITS STANDARD & HIGH VELOCITY PUMPS

The ISOLATOR[®]

UNI-FLANGE BALL VALVE[®]
SELECT WITH 4-WAY SELECTABLE FLOW PATH

IDEAL FOR GEOTHERMAL APPLICATIONS

- Easily fill, purge, sample or add a pressure gauge right at the pump
- 1" side ports enable quicker filling and purging – ideal for Geothermal applications
- Easily direct fluid between 4 available ports
- Easily isolate the pump for replacement

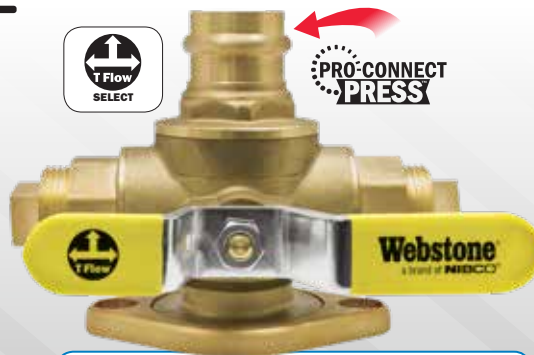

PRO-CONNECT PRESS

THE ISOLATOR SELECT

Full Port Forged Brass Uni-Flange Ball Valve w/ 4-Way Selectable Flow Path, Plugged FNPT Ports, Adjustable Packing Gland, Nuts, Bolts, & Flange Gasket

| STANDARD BRASS | | | |
|--------------------------------------|-----------|----------|------------|
| SIZE | HV ITEM# | CTN/CASE | LIST PRICE |
| FIP × Press × Rotating Flange | | | |
| 1" | H-81424HV | 1/10 | \$107.20 |

FITS STANDARD & HIGH VELOCITY PUMPS

COMPATIBLE WITH*
TACO 00e - VR15-1

THE ISOLATOR W/ ROUND FLANGE

Full Port Forged Brass Uni-Flange Ball Valve w/ Detachable Rotating Flange, Adjustable Packing Gland, Nuts & Bolts

| STANDARD BRASS | | | |
|---|-----------------|----------|------------|
| SIZE | ITEM# | CTN/CASE | LIST PRICE |
| FIP × Rotating Flange | | | |
| 1 1/2" | H-41406HV-RF375 | 1/6 | \$81.53 |
| SWT × Rotating Flange | | | |
| 1 1/2" | H-51406HV-RF375 | 1/6 | \$81.53 |
| Press × Rotating Flange | | | |
| 1 1/2" | H-81406HV-RF375 | 1/6 | \$93.22 |
| W/ MULTI-FUNCTION HI-FLOW HOSE DRAIN | | | |
| FIP × Rotating Flange | | | |
| 1 1/2" | H-41416HV-RF375 | 1/6 | \$100.60 |
| SWT × Rotating Flange | | | |
| 1 1/2" | H-51416HV-RF375 | 1/6 | \$100.60 |
| Press × Rotating Flange | | | |
| 1 1/2" | H-81416HV-RF375 | 1/6 | \$115.50 |

COMPATIBLE WITH

ARMSTRONG E.2 SERIES - E16.2/E16.2B, E30.2/E30.2B
BELL & GOSSETT ECOCIRC - XL 15-75, XL 20-140, XL 40-200
WILO STRATOS - 2.0 × 3-35

THE ISOLATOR W/ ROTATING FLANGE

Full Port Forged Brass Uni-Flange Ball Valve w/ Detachable Rotating Flange, Adjustable Packing Gland, Nuts & Bolts

| STANDARD BRASS | | | |
|---|-----------------|----------|------------|
| SIZE | ITEM# | CTN/CASE | LIST PRICE |
| FIP × Rotating Flange | | | |
| 2" | H-41407HV-RF400 | 1/6 | \$105.60 |
| SWT × Rotating Flange | | | |
| 2" | H-51407HV-RF400 | 1/6 | \$105.60 |
| Press × Rotating Flange | | | |
| 2" | H-81407HV-RF400 | 1/6 | \$120.20 |
| W/ MULTI-FUNCTION HI-FLOW HOSE DRAIN | | | |
| FIP × Rotating Flange | | | |
| 2" | H-41417HV-RF400 | 1/6 | \$130.00 |
| SWT × Rotating Flange | | | |
| 2" | H-51417HV-RF400 | 1/6 | \$130.00 |
| Press × Rotating Flange | | | |
| 2" | H-81417HV-RF400 | 1/6 | \$142.00 |

COMPATIBLE WITH

TACO 00e - VR20-1
GRUNDFOS MAGNA3 - 50-80 F, 50-150 F

THE ISOLATOR W/ ROTATING FLANGE

Full Port Forged Brass Uni-Flange Ball Valve w/ Detachable Rotating Flange, Adjustable Packing Gland, Nuts & Bolts

| STANDARD BRASS | | | |
|---|-----------------|----------|------------|
| SIZE | ITEM# | CTN/CASE | LIST PRICE |
| FIP × Rotating Flange | | | |
| 2" | H-41407HV-RF475 | 1/6 | \$105.60 |
| SWT × Rotating Flange | | | |
| 2" | H-51407HV-RF475 | 1/6 | \$105.60 |
| Press × Rotating Flange | | | |
| 2" | H-81407HV-RF475 | 1/6 | \$120.20 |
| W/ MULTI-FUNCTION HI-FLOW HOSE DRAIN | | | |
| FIP × Rotating Flange | | | |
| 2" | H-41417HV-RF475 | 1/6 | \$130.00 |
| SWT × Rotating Flange | | | |
| 2" | H-51417HV-RF475 | 1/6 | \$130.00 |
| Press × Rotating Flange | | | |
| 2" | H-81417HV-RF475 | 1/6 | \$142.00 |

2-PUMP GEOTHERMAL SYSTEM OVERVIEW

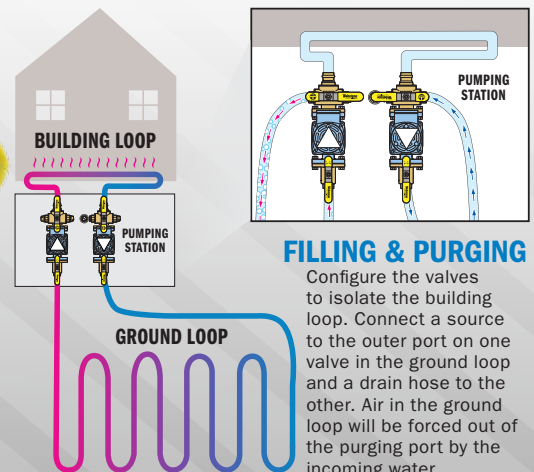

FILLING & PURGING

Configure the valves to isolate the building loop. Connect a source to the outer port on one valve in the ground loop and a drain hose to the other. Air in the ground loop will be forced out of the purging port by the incoming water.

* All manufacturer names, models and part numbers are trademarked or registered trademark property of their respective owners. Webstone products are not manufactured, sponsored, authorized, or endorsed by any party unless otherwise noted.

PATENTED TECHNOLOGY WITH FURTHER PATENTS PENDING

BALL DRAIN

THE OLD WAY

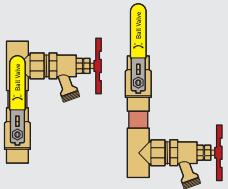

Draining from Above Ball

Draining from Below Ball

THE WEBSTONE WAY
REPLACES 4 COMPONENTS
ELIMINATES 3 LEAK PATHS
SAVES 27 MINUTES OF LABOR

- Eliminate assemblies needed to isolate & drain any portion of a piped system
- Press or SWT × FIP option designed specifically for use with pre-fabricated threaded headers
- Reversible handle for added versatility
- Exclusive adjustable flow path allows for draining from either side of the ball

T-Flow Ball



Adjustable stem directs flow into the hi-flow hose drain from either side of the ball

DRAINING FROM ABOVE BALL

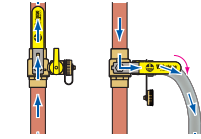

DRAINING FROM BELOW BALL

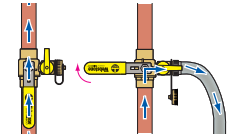

AVAILABLE W/

PRO-CONNECT PPR-PRO
EXCLUSIVELY FOR
aquatherm

SEE PAGE 6

AVAILABLE W/

PRO-CONNECT PPR-PRO
FOR ANY
PP-R OR PP-RCT
PIPING SYSTEM

SEE PAGE 7



AVAILABLE W/
PRO-CONNECT PRESS

BALL DRAIN

Full Port Forged Brass Ball Valve w/ Hi-Flow Hose Drain, Reversible Handle & Adjustable Packing Glands

STANDARD BRASS

LEAD-FREE BRASS

Certified to NSF/ANSI 61 & 372

| SIZE | ITEM # | CTN/CASE | LIST PRICE | ITEM # | CTN/CASE | LIST PRICE |
|--------------------|---------|----------|------------|----------|-------------------|------------|
| FIP | | | | | | |
| 1/2" | H-40612 | 6/36 | \$18.87 | H-40612W | 6/36 | \$23.10 |
| 3/4" | H-40613 | 6/36 | \$23.88 | H-40613W | 6/36 | \$32.26 |
| 1" | H-40614 | 4/24 | \$34.25 | H-40614W | 4/24 | \$44.52 |
| 1 1/4" | H-40615 | 2/12 | \$50.87 | H-40615W | 2/12 | \$64.26 |
| 1 1/2" | H-40616 | 2/12 | \$71.26 | H-40616W | 2/8 | \$89.86 |
| 2" | H-40617 | 1/6 | \$105.70 | H-40617W | 1/6 | \$136.80 |
| SWT | | | | | | |
| 1/2" | H-50612 | 6/36 | \$18.87 | H-50612W | 6/36 | \$23.10 |
| 3/4" | H-50613 | 6/36 | \$23.88 | H-50613W | 6/36 | \$32.26 |
| 1" | H-50614 | 4/24 | \$34.25 | H-50614W | 4/24 | \$44.52 |
| 1 1/4" | H-50615 | 2/12 | \$50.87 | H-50615W | 2/12 | \$64.26 |
| 1 1/2" | H-50616 | 2/12 | \$71.26 | H-50616W | 2/8 | \$89.86 |
| 2" | H-50617 | 1/6 | \$105.70 | H-50617W | 1/6 | \$136.80 |
| SWT × FIP | | | | | | |
| 1/2" | H-54612 | 6/36 | \$18.87 | H-54612W | 6/36 | \$23.10 |
| 3/4" | H-54613 | 6/36 | \$23.88 | H-54613W | 6/36 | \$32.26 |
| 1" | H-54614 | 4/24 | \$34.25 | H-54614W | 4/24 | \$44.52 |
| Press | | | | | | |
| 1/2" | H-80612 | 4/40 | \$25.70 | H-80612W | 4/40 | \$30.82 |
| 3/4" | H-80613 | 4/32 | \$38.40 | H-80613W | 4/32 | \$46.70 |
| 1" | H-80614 | 2/20 | \$58.89 | H-80614W | 2/20 | \$77.46 |
| 1 1/4" | H-80615 | 2/16 | \$92.21 | H-80615W | 2/16 | \$125.70 |
| 1 1/2" | - | - | - | H-80616W | 1/8 | \$179.30 |
| 2" | - | - | - | H-80617W | 1/6 | \$249.80 |
| Press × FIP | | | | | | |
| 3/4" | H-84613 | 4/32 | \$33.06 | - | 250 CWP/250 F Max | - |
| 1" | H-84614 | 2/20 | \$51.31 | - | - | - |

UNION BALL DRAIN

- All the features of the ball drain, with integrated union connection
- Easily disconnect and replace any portion of a piped system

UNION BALL DRAIN

Full Port Forged Brass Ball Valve w/ Single Union End, Hi-Flow Hose Drain, Reversible Handle & Adjustable Packing Glands

STANDARD BRASS

LEAD-FREE BRASS

Certified to NSF/ANSI 61 & 372

| SIZE | ITEM # | CTN/CASE | LIST PRICE | ITEM # | CTN/CASE | LIST PRICE |
|--------------------------|---------|----------|------------|----------|----------|------------|
| FIP Union × FIP | | | | | | |
| 3/4" | H-40433 | 6/24 | \$39.17 | H-40433W | 6/24 | \$49.49 |
| 1" | H-40434 | 4/16 | \$53.48 | H-40434W | 4/16 | \$67.92 |
| 1 1/4" | H-40435 | 2/12 | \$74.53 | H-40435W | 2/12 | \$94.21 |
| 1 1/2" | H-40436 | 2/12 | \$98.66 | H-40436W | 2/8 | \$124.00 |
| SWT × FIP Union | | | | | | |
| 3/4" | H-50433 | 6/24 | \$39.17 | H-50433W | 6/24 | \$49.49 |
| 1" | H-50434 | 4/16 | \$53.48 | H-50434W | 4/16 | \$67.92 |
| 1 1/4" | H-50435 | 2/12 | \$74.53 | H-50435W | 2/12 | \$94.21 |
| 1 1/2" | H-50436 | 2/12 | \$98.66 | H-50436W | 2/8 | \$124.00 |
| Press × FIP Union | | | | | | |
| 3/4" | - | - | - | H-80433W | 4/16 | \$57.92 |
| 1" | - | - | - | H-80434W | 2/16 | \$84.02 |
| 1 1/4" | - | - | - | H-80435W | 2/8 | \$131.00 |
| 1 1/2" | - | - | - | H-80436W | 1/5 | \$175.80 |

- Winterize an entire building with simple quarter-turn actions

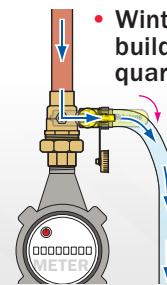

THE OLD WAY

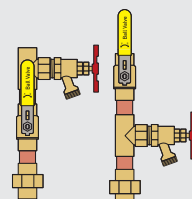

Draining from Above Ball

Draining from Below Ball

THE WEBSTONE WAY
REPLACES 6 COMPONENTS
ELIMINATES 5 LEAK PATHS
SAVES 45 MINUTES OF LABOR

T DRAIN™

AVAILABLE W/
PRO-CONNECT PRESS



THE OLD WAY



THE WEBSTONE WAY
REPLACES 2 COMPONENTS
ELIMINATES 1 LEAK PATH
SAVES 9 MINUTES OF LABOR

HANDLE OPERATION

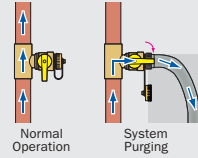

- Install anywhere a drain or purge valve is required
- Hi-flow alternative for filling, draining, or venting closed-loop hydronic systems

T-DRAIN

Full Port Forged Brass Fitting w/ Hi-Flow Hose Drain & Adjustable Packing Gland

LEAD-FREE BRASS

Certified to NSF/ANSI 61-G

| SIZE | ITEM # | CTN/CASE | LIST PRICE |
|-------------------|----------|----------|------------|
| 600 WOG | | | |
| 1/2" | H-50672W | 8/80 | \$14.70 |
| 3/4" | H-50673W | 6/48 | \$22.47 |
| 1" | H-50674W | 4/40 | \$23.93 |
| 1 1/4" | H-50675W | 4/40 | \$29.49 |
| 1 1/2" | H-50676W | 2/24 | \$37.16 |
| 2" | H-50677W | 2/20 | \$45.99 |
| 250 CWP/250 F Max | | | |
| Press | | | |
| 1/2" | H-80672W | 4/40 | \$25.18 |
| 3/4" | H-80673W | 4/16 | \$41.56 |
| 1" | H-80674W | 4/16 | \$59.39 |
| 1 1/4" | H-80675W | 4/16 | \$107.70 |

PURGE & FILL™



Divert fluids from the main flow channel into the drain

AVAILABLE W/
PRO-CONNECT PRESS



- Simultaneously drain, flush & refill any hydronic, solar, or closed loop system
- Reversible handle for added versatility

THE OLD WAY

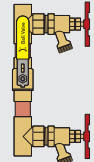

THE WEBSTONE WAY
REPLACES 7 COMPONENTS
ELIMINATES 6 LEAK PATHS
SAVES 54 MINUTES OF LABOR

HANDLE OPERATION

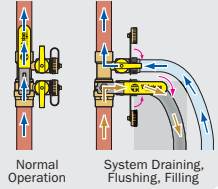

PURGE & FILL

Full Port Forged Brass Ball Valve w/ (2) Hi-Flow Hose Drains, Reversible Handle & Adjustable Packing Glands

STANDARD BRASS

| SIZE | ITEM # | CTN/CASE | LIST PRICE |
|-------------------|---------|----------|------------|
| 600 WOG | | | |
| 3/4" | H-48613 | 1/12 | \$42.96 |
| 1" | H-48614 | 1/12 | \$54.87 |
| 1 1/4" | H-48615 | 1/12 | \$71.24 |
| 1 1/2" | H-48616 | 1/12 | \$95.25 |
| 600 WOG | | | |
| SWT | | | |
| 3/4" | H-58613 | 1/12 | \$42.96 |
| 1" | H-58614 | 1/12 | \$54.87 |
| 1 1/4" | H-58615 | 1/12 | \$71.24 |
| 1 1/2" | H-58616 | 1/12 | \$95.25 |
| 250 CWP/250 F Max | | | |
| Press | | | |
| 3/4" | H-88613 | 1/12 | \$61.45 |
| 1" | H-88614 | 1/12 | \$89.43 |
| 1 1/4" | H-88615 | 1/12 | \$148.30 |
| 1 1/2" | H-88616 | 1/6 | \$203.40 |



PRIMARY/SECONDARY PURGE TEE™

- The only way to place a ball valve between closely spaced tees
- Precision crafting achieves hydraulic separation
- Ideal for primary/secondary piping

PURGE-TEE

Full Port Forged Brass Ball Valve w/ Reversible Handle & Adjustable Packing Gland

STANDARD BRASS

| SIZE | ITEM # | CTN/CASE | LIST PRICE |
|------------------------------------|---------|----------|------------|
| 600 WOG | | | |
| SWT (1" Primary Loop) | | | |
| 1" × 3/4" | H-58643 | 1/12 | \$44.82 |
| 1" × 1" | H-58644 | 1/12 | \$47.48 |
| 600 WOG | | | |
| SWT (1 1/4" Primary Loop) | | | |
| 1 1/4" × 3/4" | H-58653 | 1/12 | \$71.93 |
| 1 1/4" × 1" | H-58654 | 1/12 | \$75.01 |
| 1 1/4" × 1 1/4" | H-58655 | 1/12 | \$78.96 |
| 250 CWP/250 F Max | | | |
| Press (1" Primary Loop) | | | |
| 1" × 3/4" | H-88643 | 1/12 | \$99.42 |
| 1" × 1" | H-88644 | 1/12 | \$118.40 |
| 250 CWP/250 F Max | | | |
| Press (1 1/4" Primary Loop) | | | |
| 1 1/4" × 1" | H-88654 | 1/12 | \$188.10 |
| 1 1/4" × 1 1/4" | H-88655 | 1/12 | \$234.90 |

THE OLD WAY

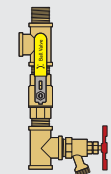

THE WEBSTONE WAY
REPLACES 7 COMPONENTS
ELIMINATES 6 LEAK PATHS
SAVES 54 MINUTES OF LABOR

HANDLE OPERATION

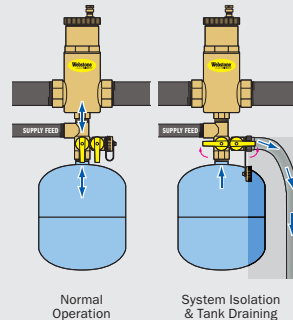

EXPANSION TANK PRO SERVICE VALVE™

- The 3-way ball controls flow between the expansion tank and the system
- Easily install, isolate, drain & replace any expansion tank
- Quickly connect entire system to the cold water feed

IDEAL FOR USE WITH
Webstone
Air Separator

THE WEBSTONE WAY
REPLACES 5 COMPONENTS*
ELIMINATES 4 LEAK PATHS
SAVES 36 MINUTES OF LABOR



THE OLD WAY
*Correct spacing for hydraulic separation cannot be achieved using off-the-shelf components.
The Purge Tee is the ONLY way to place a valve between closely spaced tees.

HANDLE OPERATION

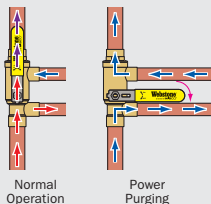

PRO-PAL EXPANSION TANK PRO SERVICE VALVE

Full Port Forged Brass Ball Valve w/ Hi-Flow Hose Drain

STANDARD BRASS

| SIZE | ITEM # | CTN/CASE | LIST PRICE |
|------------------------|---------|----------|------------|
| 600 WOG | | | |
| FIP × MIP × FIP × Hose | | | |
| 1/2" | H-41672 | 1/30 | \$28.29 |

The ISOLATOR[®] E·X·P[™] TWH SERVICE VALVES

THE ONLY WAY TO INSTALL ANY TANKLESS WATER HEATER

PATENTED TECHNOLOGY

NORMAL OPERATION

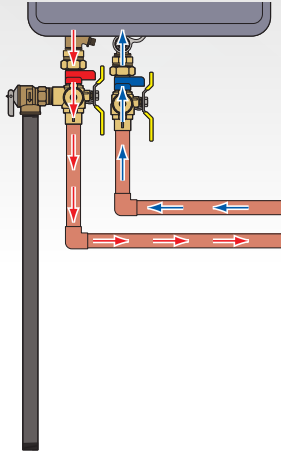

CLEANING

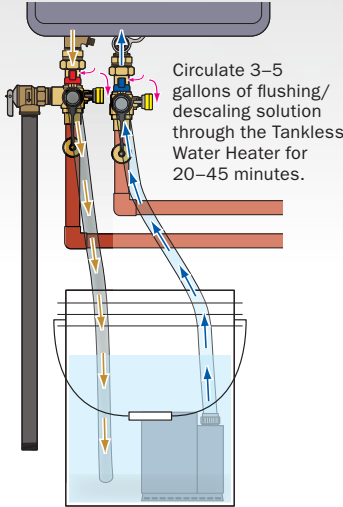

FLUSHING

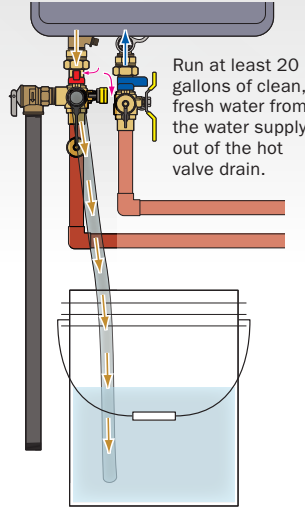

ADVANTAGES

- Quicker, consistent quality installation
- Fewer leak paths
- Allows for easy cleaning or flushing of system
- Allows for one person diagnostic testing of water heater unit

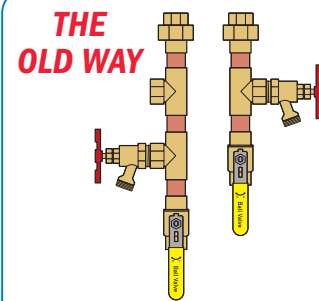

REPLACES 14 COMPONENTS
ELIMINATES 12 LEAK PATHS
SAVES 108 MINUTES OF LABOR

THE ISOLATOR E-X-P TANKLESS WATER HEATER SERVICE VALVE KIT

Hot & Cold Set of Full Port Forged Brass Ball Valves w/ Hi-Flow Hose Drains, Pressure Relief Valve Outlet & Adjustable Packing Glands

LEAD-FREE BRASS

Certified to NSF/ANSI 61 & 372

| SIZE | ITEM # | CTN/CASE | LIST PRICE |
|-----------------|----------|----------|------------|
| FIP Union × FIP | | | 600 WOG |
| 3/4" | H-40443W | 1/8 | \$169.50 |
| SWT × FIP Union | | | 600 WOG |
| 3/4" | H-50443W | 1/8 | \$169.50 |

INCLUDES RESIDENTIAL PRESSURE RELIEF VALVE (150 PSI/200,000 BTU)

| | | | |
|-----------------|------------|-----|----------|
| FIP Union × FIP | | | 600 WOG |
| 3/4" | H-40443WPR | 1/8 | \$183.00 |
| SWT × FIP Union | | | 600 WOG |
| 3/4" | H-50443WPR | 1/8 | \$183.00 |

INCLUDES COMMERCIAL GRADE PRESSURE RELIEF VALVE (150 PSI/2.7M BTU) & CLOSE NIPPLE

| | | | |
|-----------------|-------------|-----|----------|
| FIP Union × FIP | | | 600 WOG |
| 3/4" | H-40443WPR2 | 1/8 | \$240.30 |
| SWT × FIP Union | | | 600 WOG |
| 3/4" | H-50443WPR2 | 1/8 | \$240.30 |

The ISOLATOR[®] E·X·P[™] TWH SERVICE VALVES

PREMIUM DESIGN



The ISOLATOR[®] E·X·P E2[™] TWH SERVICE VALVES

SPACE SAVING



THE ISOLATOR E-X-P E3 TANKLESS WATER HEATER SERVICE VALVE KIT

Hot & Cold Set of Full Port Forged Brass Ball Valves w/ Hi-Flow Hose Drains, Adjustable Pressure Relief Valve Outlet & Adjustable Packing Glands

LEAD-FREE BRASS

Certified to NSF/ANSI 61 & 372

| SIZE | ITEM # | CTN/CASE | LIST PRICE |
|-----------------|------------|----------|------------|
| FIP Union × FIP | | | 500 WOG |
| 3/4" | H-45443WPR | 1/10 | \$129.10 |
| FIP Union × SWT | | | 500 WOG |
| 3/4" | H-55443WPR | 1/10 | \$129.10 |

INCLUDES RESIDENTIAL PRESSURE RELIEF VALVE (150 PSI/200,000 BTU)

| | | | |
|-------------------|------------|------|-------------------|
| FIP Union × Push* | | | 200 PSI/200 F Max |
| 3/4" | H-65443WPR | 1/10 | \$140.70 |

INCLUDES LEAD FREE RESIDENTIAL PRESSURE RELIEF VALVE (150 PSI/200,000 BTU)

| | | | |
|-------------------|---------------|------|-------------------|
| FIP Union × Push* | | | 200 PSI/200 F Max |
| 3/4" | H-65443WPR-LF | 1/10 | \$152.70 |

INCLUDES COMMERCIAL GRADE PRESSURE RELIEF VALVE (150 PSI/2.7M BTU) & CLOSE NIPPLE

| | | | |
|-----------------|-------------|------|----------|
| FIP Union × FIP | | | 500 WOG |
| 3/4" | H-45443WPR2 | 1/10 | \$186.50 |
| FIP Union × SWT | | | 500 WOG |
| 3/4" | H-55443WPR2 | 1/10 | \$186.50 |

*SERVICE VALVES CERTIFIED TO ASSE 1061, NSF-14

THE ISOLATOR E-X-P E2 TANKLESS WATER HEATER SERVICE VALVE KIT

Hot & Cold Set of Full Port Forged Brass Ball Valves w/ Hi-Flow Hose Drains, Pressure Relief Valve Outlet & Adjustable Packing Glands

LEAD-FREE BRASS

Certified to NSF/ANSI 61 & 372

| SIZE | ITEM # | CTN/CASE | LIST PRICE |
|---|--------|----------|------------|
| INCLUDES RESIDENTIAL PRESSURE RELIEF VALVE (150 PSI/200,000 BTU) | | | |

| | | | |
|-----------------|------------|------|----------|
| FIP Union × FIP | | | 500 WOG |
| 3/4" | H-44443WPR | 1/10 | \$113.20 |
| 1" | H-44444WPR | 1/10 | \$192.30 |

| | | | |
|-----------------|------------|------|----------|
| FIP Union × SWT | | | 500 WOG |
| 3/4" | H-54443WPR | 1/10 | \$113.20 |
| 1" | H-54444WPR | 1/10 | \$192.30 |

| | | | |
|-------------------|------------|------|-------------------|
| FIP Union × Press | | | 250 CWP/250 F Max |
| 3/4" | H-84443WPR | 1/10 | \$127.50 |
| 1" | H-84444WPR | 1/10 | \$216.40 |

| | | | |
|-------------------|------------|------|-------------------|
| FIP Union × Push* | | | 200 PSI/200 F Max |
| 3/4" | H-64443WPR | 1/10 | \$127.50 |

INCLUDES LEAD FREE RESIDENTIAL PRESSURE RELIEF VALVE (150 PSI/200,000 BTU)

| | | | |
|-----------------|---------------|------|----------|
| FIP Union × FIP | | | 500 WOG |
| 3/4" | H-44443WPR-LF | 1/10 | \$122.50 |
| 1" | H-44444WPR-LF | 1/10 | \$201.60 |

| | | | |
|-----------------|---------------|------|----------|
| FIP Union × SWT | | | 500 WOG |
| 3/4" | H-54443WPR-LF | 1/10 | \$122.50 |

| | | | |
|-------------------|---------------|------|-------------------|
| FIP Union × Press | | | 250 CWP/250 F Max |
| 3/4" | H-84443WPR-LF | 1/10 | \$136.80 |
| 1" | H-84444WPR-LF | 1/10 | \$225.70 |

| | | | |
|-------------------|---------------|------|-------------------|
| FIP Union × Push* | | | 200 PSI/200 F Max |
| 3/4" | H-64443WPR-LF | 1/10 | \$136.80 |

INCLUDES COMMERCIAL GRADE PRESSURE RELIEF VALVE (150 PSI/2.7M BTU) & CLOSE NIPPLE

| | | | |
|-----------------|-------------|------|----------|
| FIP Union × FIP | | | 500 WOG |
| 3/4" | H-44443WPR2 | 1/10 | \$170.60 |
| 1" | H-44444WPR2 | 1/10 | \$249.60 |

| | | | |
|-----------------|-------------|------|----------|
| FIP Union × SWT | | | 500 WOG |
| 3/4" | H-54443WPR2 | 1/10 | \$170.60 |
| 1" | H-54444WPR2 | 1/10 | \$249.60 |

| | | | |
|-------------------|-------------|------|-------------------|
| FIP Union × Press | | | 250 CWP/250 F Max |
| 3/4" | H-84443WPR2 | 1/10 | \$184.80 |
| 1" | H-84444WPR2 | 1/10 | \$273.70 |

*SERVICE VALVES CERTIFIED TO ASSE 1061, NSF-14

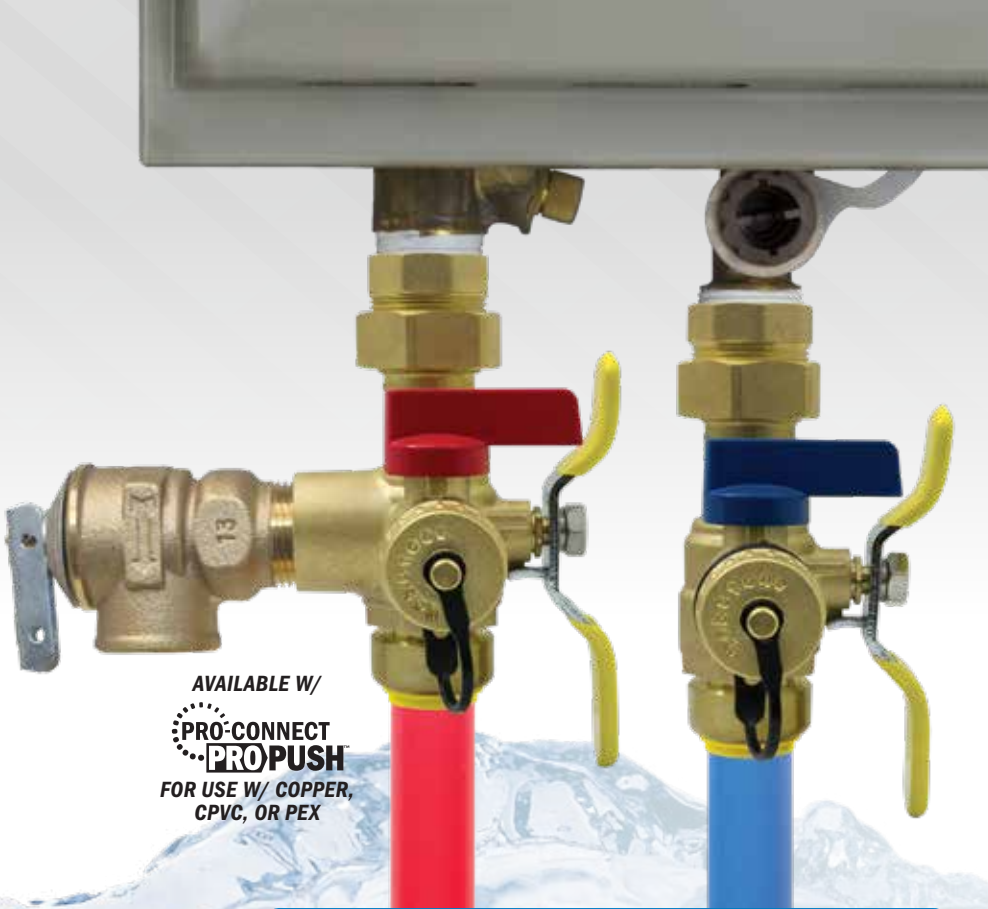

AVAILABLE W/
**PRO-CONNECT
 PROPUSH**
 FOR USE W/ COPPER,
 CPVC, OR PEX

The ISOLATOR
E·X·P
 TWH SERVICE VALVES
 COMPLETE



THE ISOLATOR E-X-P COMPLETE TANKLESS WATER HEATER INSTALLATION KIT

Includes E-X-P/E2/E3 Service Valves
 w/ Residential Pressure Relief Valve (150 PSI/200,000 BTU)
 3/4" CGA Gas Ball Valve (175 WOG) & 24" x 3/4" Gas Flex Line

LEAD-FREE BRASS

Certified to NSF/ANSI 61 & 372

| SIZE | ITEM # | CTN/CASE | LIST PRICE |
|------------------------------|-------------|----------|------------|
| THE ISOLATOR E-X-P | | | |
| FIP Union x FIP | | | 500 WOG |
| 3/4" | H-40443WCOM | 1/4 | \$231.80 |
| SWT x FIP Union | | | 600 WOG |
| 3/4" | H-50443WCOM | 1/4 | \$231.80 |
| THE ISOLATOR E-X-P E2 | | | |
| FIP Union x FIP | | | 500 WOG |
| 3/4" | H-44443WCOM | 1/4 | \$162.00 |
| FIP Union x SWT | | | 500 WOG |
| 3/4" | H-54443WCOM | 1/4 | \$162.00 |
| THE ISOLATOR E-X-P E3 | | | |
| FIP Union x FIP | | | 500 WOG |
| 3/4" | H-45443WCOM | 1/4 | \$177.90 |
| FIP Union x SWT | | | 500 WOG |
| 3/4" | H-55443WCOM | 1/4 | \$177.90 |

PRESSURE RELIEF VALVES

STANDARD BRASS

LEAD-FREE BRASS

| SIZE | ITEM # | CTN/CASE | LIST PRICE | ITEM # | CTN/CASE | LIST PRICE |
|---|---------|----------|------------|----------|----------|------------|
| RESIDENTIAL PRESSURE RELIEF VALVE | | | | | | |
| 150 PSI/200,000 BTU | | | | | | |
| 3/4" | H-20713 | 1/100 | \$13.54 | H-20713W | 1/100 | \$22.85 |
| 30 PSI/510,000 BTU | | | | | | |
| 3/4" | H-20733 | 1/100 | \$23.97 | - | - | - |
| COMMERCIAL GRADE PRESSURE RELIEF VALVE (REQUIRES CLOSE NIPPLE # 29003) | | | | | | |
| 150 PSI/2.7M BTU | | | | | | |
| 3/4" | H-20723 | 1/24 | \$67.25 | - | - | - |
| Close Nipple | | | | | | |
| 3/4" | H-29003 | 1/100 | \$3.62 | H-29003W | 1/100 | \$3.62 |

CERTIFICATIONS DO NOT APPLY TO 29003 & 29003W

THE ISOLATOR E-X-P PRESSURE RELIEF VALVE RELOCATION ADAPTER

For Recessed Boxes, Tight or Unique Installations

LEAD-FREE BRASS

Certified to NSF/ANSI 61-G

| SIZE | ITEM # | CTN/CASE | LIST PRICE |
|---------------|----------|----------|------------|
| Fits E-X-P E2 | | | |
| 3/4" | H-28023W | 10/100 | \$15.90 |

WALL HUNG & COMBI BOILER INSTALLATIONS

- PR3 Kits **A** include a 30 PSI/510,000 BTU Pressure Relief Valve suitable for boiler heat connections
- Pair with **B** E2 or E3 Tankless Water Heater Kit, which includes a 150 PSI Pressure Relief Valve suitable for combi boiler domestic hot water connections

WALL HUNG & COMBI BOILER SERVICE VALVE KIT

Hot & Cold Set of Full Port Forged Brass Ball Valves w/ Hi-Flow Hose Drains, Pressure Relief Valve Outlet & Adjustable Packing Glands

Includes Residential Pressure Relief Valve (30 PSI/510,000 BTU)

500 WOG

| STANDARD BRASS | | | | LEAD-FREE BRASS | | |
|---|------------|----------|------------|------------------------|----------|------------|
| SIZE | ITEM # | CTN/CASE | LIST PRICE | ITEM # | CTN/CASE | LIST PRICE |
| FIP Union x FIP | | | | | | |
| 3/4" | - | - | - | H-44443WPR3 | 1/10 | \$123.70 |
| 1" | H-44444PR3 | 1/10 | \$175.00 | H-44444WPR3 | 1/10 | \$202.70 |
| FIP Union x SWT | | | | | | |
| 3/4" | - | - | - | H-54443WPR3 | 1/10 | \$123.70 |
| 1" | - | - | - | H-54444WPR3 | 1/10 | \$202.70 |
| FIP Union x Press | | | | | | |
| 250 CWP/250 F Max | | | | | | |
| 3/4" | - | - | - | H-84443WPR3 | 1/10 | \$137.90 |
| 1" | - | - | - | H-84444WPR3 | 1/10 | \$226.80 |
| INCLUDES ADJUSTABLE PRESSURE RELIEF VALVE OUTLET | | | | | | |
| FIP Union x FIP | | | | | | |
| 3/4" | - | - | - | H-45443WPR3 | 1/10 | \$139.60 |
| FIP Union x SWT | | | | | | |
| 3/4" | - | - | - | H-55443WPR3 | 1/10 | \$139.60 |

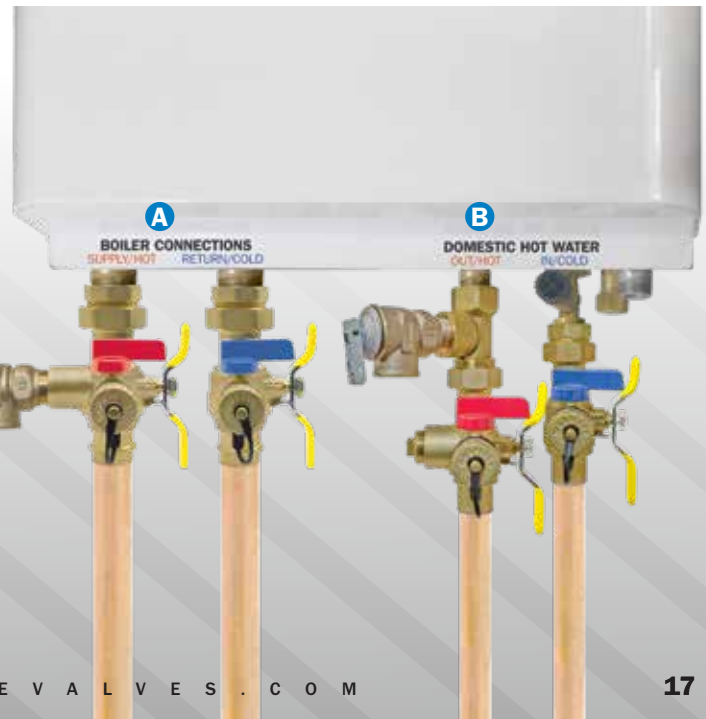

THERMOSTATIC MIXING VALVES



- Heavy Duty Forged Brass Construction
- Output Range 95–131°F or 95–120°F
- Available w/ Integral Check Valves on inlets
- MIP, SWT, Compression, F1807 PEX, or Press Connections
- Sizes 3/8" – 1"
- Union connections on most models simplify installation and maintenance
- 95–131°F models feature a temperature locking handle to ensure appropriate output range

| APPLICATION: | LOW-TEMPERATURE HYDRONIC | | WATER DISTRIBUTION SYSTEMS | | | | POINT OF USE SINGLE OR MULTI FIXTURE | | POINT OF USE SINGLE ONLY |
|--------------|--------------------------|----------|----------------------------|----------|--------------------|-----------|--------------------------------------|--------------------|--------------------------|
| | 95–131°F (35–55°C) | | 95–131°F (35–55°C) | | 95–120°F (35–49°C) | | 95–131°F (35–55°C) | 95–120°F (35–49°C) | 95–131°F (35–55°C) |
| | NO CHECK | W/ CHECK | NO CHECK | W/ CHECK | NO CHECK | W/ CHECK | W/ CHECK | W/ CHECK | W/ CHECK |
| Compression | - | - | - | - | - | - | - | - | 7440W |
| MIP | 7410W | 7420W | 7410W | 7420W | 7410W-CAN | 7420W-CAN | 7420W | 7420W-CAN | - |
| SWT | 7510W | 7520W | 7510W | 7520W | 7510W-CAN | 7520W-CAN | 7520W | 7520W-CAN | - |
| F1807 PEX | 7110W | 7120W | 7110W | 7120W | 7110W-CAN | 7120W-CAN | - | - | - |
| Press | 7810W | 7820W | 7810W | 7820W | 7810W-CAN | 7820W-CAN | - | - | - |

APPLICATIONS:

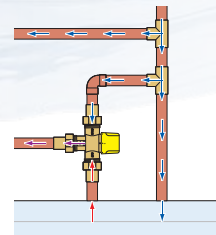

WATER DISTRIBUTION SYSTEMS
Install at water heater to set the maximum temperature for entire system

LOW TEMP HYDRONIC

Set the maximum temperature for radiant floor installations

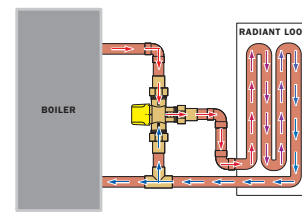

POINT OF USE - MULTI FIXTURE

Set the maximum temperature for a group of fixtures

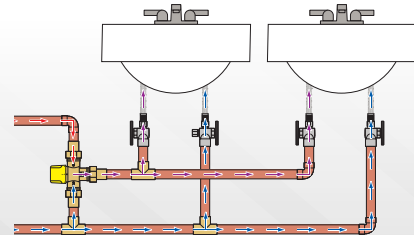

POINT OF USE - SINGLE FIXTURE

Set the maximum temperature of each fixture individually

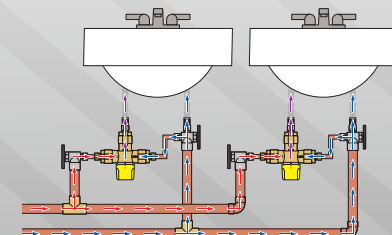

THERMOSTATIC MIXING VALVE

Forged Brass Valve • Lead-Free

OUTLET TEMPERATURE RANGE 95–131° F

Certified to NSF/ANSI 61 & 372, ASSE 1017, CSA B125.3

| SIZE | ITEM # | CTN/CASE | LIST PRICE |
|------|----------|----------|------------|
| MIP | | | |
| 1/2" | H-74102W | 1/10 | \$107.10 |
| 3/4" | H-74103W | 1/10 | \$113.50 |
| 1" | H-74104W | 1/10 | \$162.40 |
| SWT | | | |
| 1/2" | H-75102W | 1/10 | \$107.10 |
| 3/4" | H-75103W | 1/10 | \$113.50 |
| 1" | H-75104W | 1/10 | \$162.40 |

OUTLET TEMPERATURE RANGE 95–120° F

Certified to NSF/ANSI 61 & 372, ASSE 1017, CSA B125.3

| SIZE | ITEM # | CTN/CASE | LIST PRICE |
|------|--------------|----------|------------|
| MIP | | | 150 PSI |
| 1/2" | H-74102W-CAN | 1/10 | \$107.10 |
| 3/4" | H-74103W-CAN | 1/10 | \$113.50 |
| 1" | H-74104W-CAN | 1/10 | \$162.40 |
| SWT | | | 150 PSI |
| 1/2" | H-75102W-CAN | 1/10 | \$107.10 |
| 3/4" | H-75103W-CAN | 1/10 | \$113.50 |
| 1" | H-75104W-CAN | 1/10 | \$162.40 |

OUTLET TEMPERATURE RANGE 95–131° F

Certified to NSF/ANSI 61 & 372, Body (H-70000W) Certified to ASSE 1017, CSA B125.3

| SIZE | ITEM # | CTN/CASE | LIST PRICE |
|----------------|-----------|----------|------------|
| ASTM F1807 PEX | | | 150 PSI |
| 1/2" | H-71102W* | 1/10 | \$107.10 |
| 3/4" | H-71103W* | 1/10 | \$113.50 |
| Press | | | 150 PSI |
| 1/2" | H-78102W | 1/10 | \$126.30 |
| 3/4" | H-78103W | 1/10 | \$139.80 |
| 1" | H-78104W | 1/10 | \$192.60 |

OUTLET TEMPERATURE RANGE 95–120° F

Certified to NSF/ANSI 61 & 372, Body (H-70000W) Certified to ASSE 1017, CSA B125.3

| SIZE | ITEM # | CTN/CASE | LIST PRICE |
|----------------|---------------|----------|------------|
| ASTM F1807 PEX | | | 150 PSI |
| 1/2" | H-71102W-CAN* | 1/10 | \$107.10 |
| 3/4" | H-71103W-CAN* | 1/10 | \$113.50 |
| Press | | | 150 PSI |
| 1/2" | H-78102W-CAN | 1/10 | \$126.30 |
| 3/4" | H-78103W-CAN | 1/10 | \$139.80 |
| 1" | H-78104W-CAN | 1/10 | \$192.60 |

*NEW ITEM NUMBER - FORMERLY H-7310W SERIES

THERMOSTATIC MIXING VALVE W/ INTEGRAL CHECK VALVE

Forged Brass Valve • Lead-Free

OUTLET TEMPERATURE RANGE 95–131° F

Certified to NSF/ANSI 61 & 372, ASSE 1070, ASSE 1017, CSA B125.3

| SIZE | ITEM # | CTN/CASE | LIST PRICE |
|-------------|----------|----------|------------|
| Compression | | | 150 PSI |
| 3/8" | H-74401W | 1/10 | \$98.25 |
| MIP | | | 150 PSI |
| 1/2" | H-74202W | 1/10 | \$107.10 |
| 3/4" | H-74203W | 1/10 | \$113.50 |
| 1" | H-74204W | 1/10 | \$162.40 |
| SWT | | | 150 PSI |
| 1/2" | H-75202W | 1/10 | \$107.10 |
| 3/4" | H-75203W | 1/10 | \$113.50 |
| 1" | H-75204W | 1/10 | \$162.40 |

OUTLET TEMPERATURE RANGE 95–120° F

Certified to NSF/ANSI 61 & 372, Body (H-70000W) Certified to ASSE 1017, CSA B125.3

| SIZE | ITEM # | CTN/CASE | LIST PRICE |
|-------------|--------------|----------|------------|
| Compression | | | 150 PSI |
| 3/8" | H-74401W | 1/10 | \$98.25 |
| MIP | | | 150 PSI |
| 1/2" | H-74202W-CAN | 1/10 | \$107.10 |
| 3/4" | H-74203W-CAN | 1/10 | \$113.50 |
| 1" | H-74204W-CAN | 1/10 | \$162.40 |
| SWT | | | 150 PSI |
| 1/2" | H-75202W-CAN | 1/10 | \$107.10 |
| 3/4" | H-75203W-CAN | 1/10 | \$113.50 |
| 1" | H-75204W-CAN | 1/10 | \$162.40 |

OUTLET TEMPERATURE RANGE 95–131° F

Certified to NSF/ANSI 61 & 372, Body (H-70000W) Certified to ASSE 1017, CSA B125.3

| SIZE | ITEM # | CTN/CASE | LIST PRICE |
|----------------|-----------|----------|------------|
| ASTM F1807 PEX | | | 150 PSI |
| 1/2" | H-71202W* | 1/10 | \$107.10 |
| 3/4" | H-71203W* | 1/10 | \$113.50 |
| Press | | | 150 PSI |
| 1/2" | H-78202W | 1/10 | \$126.30 |
| 3/4" | H-78203W | 1/10 | \$139.80 |
| 1" | H-78204W | 1/10 | \$192.60 |

OUTLET TEMPERATURE RANGE 95–120° F

Certified to NSF/ANSI 61 & 372, Body (H-70000W) Certified to ASSE 1017, CSA B125.3

| SIZE | ITEM # | CTN/CASE | LIST PRICE |
|----------------|---------------|----------|------------|
| ASTM F1807 PEX | | | 150 PSI |
| 1/2" | H-71202W-CAN* | 1/10 | \$107.10 |
| 3/4" | H-71203W-CAN* | 1/10 | \$113.50 |
| Press | | | 150 PSI |
| 1/2" | H-78202W-CAN | 1/10 | \$126.30 |
| 3/4" | H-78203W-CAN | 1/10 | \$139.80 |
| 1" | H-78204W-CAN | 1/10 | \$192.60 |

*NEW ITEM NUMBER - FORMERLY H-7320W SERIES

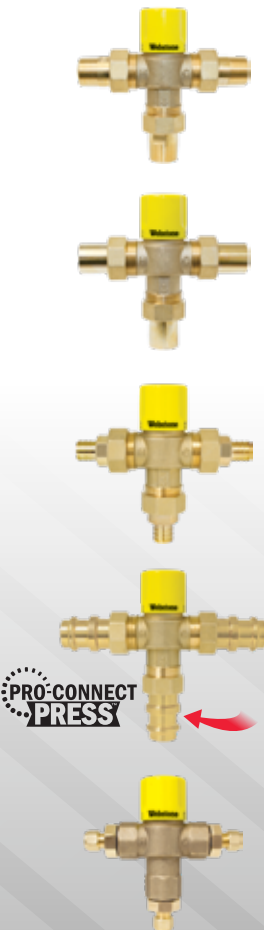

AIR SEPARATOR

KNOCKING PIPES
ARE **NOT NORMAL**

- Reduces noise
- Improves system efficiency and operation
- Reduces wear on system components
- Requires no regular maintenance
- Fewer call backs



AVAILABLE IN
**PRO-CONNECT
PRESS**

**IDEAL FOR
USE WITH**

**PRO-PAL
SERIES**

**EXPANSION TANK
PRO SERVICE VALVE**

FORGED BRASS AIR SEPARATOR

w/ Removable Vent Head & Coalescing Medium

| SIZE | ITEM # | STANDARD BRASS | |
|--------------|---------|----------------|------------|
| | | CTN/CASE | LIST PRICE |
| FIP | | | 150 PSI |
| 3/4" | H-74003 | 1/10 | \$91.12 |
| 1" | H-74004 | 1/10 | \$128.20 |
| 1 1/4" | H-74005 | 1/10 | \$166.90 |
| 1 1/2" | H-74006 | 1/10 | \$232.00 |
| 2" | H-74007 | 1/10 | \$285.90 |
| SWT | | | 150 PSI |
| 3/4" | H-75003 | 1/10 | \$91.12 |
| 1" | H-75004 | 1/10 | \$128.20 |
| 1 1/4" | H-75005 | 1/10 | \$166.90 |
| 1 1/2" | H-75006 | 1/10 | \$232.00 |
| 2" | H-75007 | 1/10 | \$285.90 |
| Press | | | 150 PSI |
| 3/4" | H-78003 | 1/10 | \$102.50 |
| 1" | H-78004 | 1/10 | \$144.20 |
| 1 1/4" | H-78005 | 1/10 | \$202.40 |
| 1 1/2" | H-78006 | 1/10 | \$288.70 |
| 2" | H-78007 | 1/10 | \$345.30 |

REPLACEMENT VENT ASSEMBLY

| SIZE | ITEM # | CTN/CASE | LIST PRICE |
|----------------------------|---------|----------|------------|
| FITS 3/4"-2" AIR SEPARATOR | H-74000 | 1/50 | \$30.50 |

VALVE ACCESSORIES



BRONZE WYE STRAINER

20 Mesh Screen

| SIZE | ITEM # | CTN/CASE | LIST PRICE |
|------------|---------|-----------------|------------|
| FIP | | 300 WOG/150 WSP | |
| 1/2" | H-10562 | 12/60 | \$27.17 |
| 3/4" | H-10563 | 8/48 | \$38.56 |
| 1" | H-10564 | 8/32 | \$60.31 |
| 1 1/4" | H-10565 | 8/32 | \$88.80 |
| 1 1/2" | H-10566 | 2/16 | \$117.60 |
| 2" | H-10567 | 2/8 | \$181.30 |



STAINLESS STEEL LIQUID FILLED DUAL SCALE PRESSURE GAUGE

2" Dial w/ Center Back Connection

| SIZE | ITEM # | CTN/CASE | LIST PRICE |
|------------|---------|----------|------------|
| NPT | | 30 PSI | |
| 1/4" | H-31000 | 1/100 | \$35.02 |

ADD-A-GAUGE

**TO ANY STANDARD HOSE
CONNECTION IN JUST MINUTES**

PATENTS PENDING

- Utilize any hose connection as a gauge port
- Suitable for temporary or permanent gauge installation
- Works with temperature and/or pressure gauges

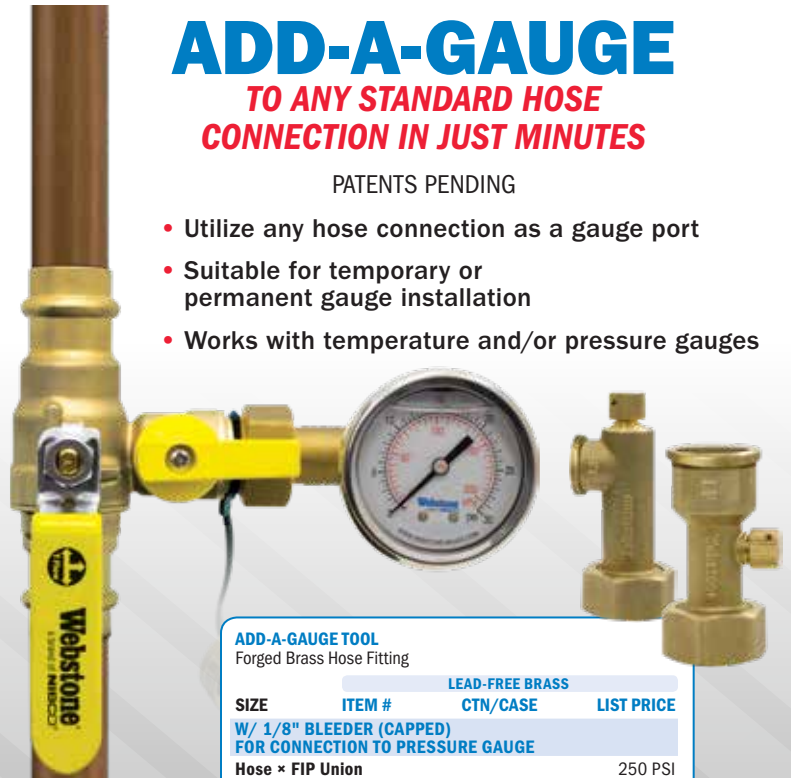

ADD-A-GAUGE TOOL

Forged Brass Hose Fitting

| SIZE | ITEM # | LEAD-FREE BRASS | |
|--|-------------|-----------------|------------|
| | | CTN/CASE | LIST PRICE |
| W/ 1/8" BLEEDER (CAPPED) FOR CONNECTION TO PRESSURE GAUGE | | | 250 PSI |
| Hose x FIP Union | | | |
| 3/4" x 1/4" | H-30000W-P | 10/100 | \$8.85 |
| W/ 1/8" BLEEDER (CAPPED) FOR CONNECTION TO TEMPERATURE/PRESSURE GAUGE | | | 250 PSI |
| Hose x FIP Union | | | |
| 3/4" x 1/2" | H-30000W-TP | 10/100 | \$8.85 |

BALL VALVES

PATENTS PENDING

FULL PORT FORGED BRASS BALL VALVE

w/ Adjustable Packing Gland

STANDARD BRASS

Certified to NSF/ANSI 61-8

LEAD-FREE BRASS

Certified to NSF/ANSI 61-8 & 61-2012

| SIZE | ITEM # | CTN/CASE | LIST PRICE | ITEM # | CTN/CASE | LIST PRICE |
|------|--------|----------|------------|--------|----------|------------|
|------|--------|----------|------------|--------|----------|------------|

FIP

w/ Chrome Plated Lever Handle 600 WOG/150 WSP(400 WOG/125 WSP 2½-4")

| | | | | | | |
|--------|---------|--------|----------|----------|--------|----------|
| 1/4" | H-41700 | 10/100 | \$7.13 | H-41700W | 10/100 | \$9.49 |
| 3/8" | H-41701 | 10/100 | \$7.13 | H-41701W | 10/100 | \$9.49 |
| 1/2" | H-41702 | 10/80 | \$6.73 | H-41702W | 10/80 | \$8.70 |
| 3/4" | H-41703 | 10/60 | \$9.91 | H-41703W | 10/60 | \$12.60 |
| 1" | H-41704 | 6/36 | \$19.94 | H-41704W | 6/36 | \$20.87 |
| 1 1/4" | H-41705 | 6/24 | \$29.80 | H-41705W | 6/24 | \$35.42 |
| 1 1/2" | H-41706 | 2/16 | \$46.70 | H-41706W | 2/16 | \$56.49 |
| 2" | H-41707 | 2/12 | \$67.92 | H-41707W | 2/12 | \$84.60 |
| 2 1/2" | H-41708 | 1/6 | \$145.50 | H-41708W | 1/6 | \$183.30 |
| 3" | H-41709 | 1/4 | \$211.10 | H-41709W | 1/4 | \$284.10 |
| 4" | H-41710 | 1/2 | \$341.50 | H-41710W | 1/2 | \$436.30 |

CERTIFICATIONS DO NOT APPLY TO 41708, 41709, 41710

w/ 304 Stainless Steel Handle

| | | | | | | |
|--------|------------|-------|---------|-------------|-------|---------|
| 1/2" | H-41702SSL | 10/80 | \$10.43 | H-41702WSSL | 10/80 | \$12.40 |
| 3/4" | H-41703SSL | 10/60 | \$13.62 | H-41703WSSL | 10/60 | \$16.30 |
| 1" | H-41704SSL | 6/36 | \$23.64 | H-41704WSSL | 6/36 | \$24.57 |
| 1 1/4" | H-41705SSL | 6/24 | \$33.51 | H-41705WSSL | 6/24 | \$39.12 |
| 1 1/2" | H-41706SSL | 2/16 | \$53.51 | H-41706WSSL | 2/16 | \$63.30 |
| 2" | H-41707SSL | 2/12 | \$74.74 | H-41707WSSL | 2/12 | \$91.40 |

w/ Wing Style "T" Handle

| | | | | | | |
|------|----------|-------|---------|-----------|-------|---------|
| 1/2" | H-41702T | 10/80 | \$8.35 | H-41702WT | 10/80 | \$10.32 |
| 3/4" | H-41703T | 10/60 | \$11.54 | H-41703WT | 10/60 | \$14.22 |
| 1" | H-41704T | 6/36 | \$21.56 | H-41704WT | 6/36 | \$22.49 |

w/ 304 Stainless Steel Wing Style "T" Handle

| | | | | | | |
|------|------------|-------|---------|-------------|-------|---------|
| 1/2" | H-41702SSW | 10/80 | \$10.43 | H-41702WSSW | 10/80 | \$12.40 |
| 3/4" | H-41703SSW | 10/60 | \$13.62 | H-41703WSSW | 10/60 | \$16.30 |
| 1" | H-41704SSW | 6/48 | \$23.64 | H-41704WSSW | 6/48 | \$24.57 |

STANDARD BRASS

Certified to NSF/ANSI 61-8

LEAD-FREE BRASS

Certified to NSF/ANSI 61-8 & 61-2012

| SIZE | ITEM # | CTN/CASE | LIST PRICE | ITEM # | CTN/CASE | LIST PRICE |
|------|--------|----------|------------|--------|----------|------------|
|------|--------|----------|------------|--------|----------|------------|

SWT

w/ Chrome Plated Lever Handle 600 WOG/150 WSP(400 WOG/125 WSP 2½-4")

| | | | | | | |
|--------|---------|--------|----------|----------|-------|----------|
| 1/2" | H-51702 | 10/100 | \$6.73 | H-51702W | 10/80 | \$8.70 |
| 3/4" | H-51703 | 10/60 | \$9.91 | H-51703W | 10/60 | \$12.60 |
| 1" | H-51704 | 6/36 | \$19.94 | H-51704W | 6/36 | \$20.87 |
| 1 1/4" | H-51705 | 6/24 | \$29.80 | H-51705W | 6/24 | \$35.42 |
| 1 1/2" | H-51706 | 2/24 | \$46.70 | H-51706W | 2/16 | \$56.49 |
| 2" | H-51707 | 2/12 | \$67.92 | H-51707W | 2/12 | \$84.60 |
| 2 1/2" | H-51708 | 1/8 | \$145.50 | H-51708W | 1/6 | \$183.30 |
| 3" | H-51709 | 1/3 | \$211.10 | H-51709W | 1/4 | \$284.10 |
| 4" | H-51710 | 1/2 | \$341.50 | H-51710W | 1/2 | \$436.30 |

CERTIFICATIONS DO NOT APPLY TO 51708, 51709W, 51709, 51709W

w/ 304 Stainless Steel Handle

| | | | | | | |
|--------|------------|-------|---------|-------------|-------|---------|
| 1/2" | H-51702SSL | 10/80 | \$10.43 | H-51702WSSL | 10/80 | \$12.40 |
| 3/4" | H-51703SSL | 10/60 | \$13.62 | H-51703WSSL | 10/60 | \$16.30 |
| 1" | H-51704SSL | 6/36 | \$23.64 | H-51704WSSL | 6/36 | \$24.57 |
| 1 1/4" | H-51705SSL | 6/24 | \$33.51 | H-51705WSSL | 6/24 | \$39.12 |
| 1 1/2" | H-51706SSL | 2/24 | \$53.51 | H-51706WSSL | 2/16 | \$63.30 |
| 2" | H-51707SSL | 2/12 | \$74.74 | H-51707WSSL | 2/12 | \$91.40 |

w/ Wing Style "T" Handle

| | | | | | | |
|------|----------|-------|---------|-----------|-------|---------|
| 1/2" | H-51702T | 10/80 | \$8.35 | H-51702WT | 10/80 | \$10.32 |
| 3/4" | H-51703T | 10/60 | \$11.54 | H-51703WT | 10/60 | \$14.22 |
| 1" | H-51704T | 6/36 | \$21.56 | H-51704WT | 6/36 | \$22.49 |

w/ 304 Stainless Steel Wing Style "T" Handle

| | | | | | | |
|------|------------|-------|---------|-------------|-------|---------|
| 1/2" | H-51702SSW | 10/80 | \$10.43 | H-51702WSSW | 10/80 | \$12.40 |
| 3/4" | H-51703SSW | 10/60 | \$13.62 | H-51703WSSW | 10/60 | \$16.30 |
| 1" | H-51704SSW | 6/36 | \$23.64 | H-51704WSSW | 6/36 | \$24.57 |

STANDARD BRASS

Certified to NSF/ANSI 61

LEAD-FREE BRASS

Certified to NSF/ANSI 61-G

| SIZE | ITEM # | CTN/CASE | LIST PRICE | ITEM # | CTN/CASE | LIST PRICE |
|------|--------|----------|------------|--------|----------|------------|
|------|--------|----------|------------|--------|----------|------------|

PRESS

| | | | | | | |
|--------|---------|------|----------|----------|------|----------|
| 1/2" | H-81702 | 5/50 | \$21.01 | H-81702W | 5/50 | \$21.97 |
| 3/4" | H-81703 | 5/40 | \$25.73 | H-81703W | 5/40 | \$28.39 |
| 1" | H-81704 | 4/20 | \$39.03 | H-81704W | 4/20 | \$41.56 |
| 1 1/4" | H-81705 | 5/20 | \$63.08 | H-81705W | 5/20 | \$69.39 |
| 1 1/2" | H-81706 | 4/16 | \$87.94 | H-81706W | 4/16 | \$96.13 |
| 2" | H-81707 | 2/8 | \$136.50 | H-81707W | 2/8 | \$147.60 |
| 2 1/2" | - | - | - | H-81708W | 1/1 | \$281.30 |
| 3" | - | - | - | H-81709W | 1/1 | \$391.30 |
| 4" | - | - | - | H-81710W | 1/1 | \$671.00 |

PRO-CONNECT PRO-PUSH BALL VALVE

Full Port Forged Dezincification Resistant Brass w/ Adjustable Packing Gland - For Connection to Copper, CPVC, or PEX - Lead-Free

INDIVIDUALLY PACKED

Certified to NSF/ANSI 61-G, NSF/ANSI-14, IAPMO/ANSI Z1157

BULK PACKED

Certified to NSF/ANSI 61-G, NSF/ANSI-14, IAPMO/ANSI Z1157

| SIZE | ITEM # | CTN/CASE | LIST PRICE | ITEM # | BOX/CASE | LIST PRICE |
|------|----------|----------|------------|------------|----------|------------|
| 1/2" | H-62702W | 10/100 | \$15.72 | H-62702W-B | 12/72 | \$15.72 |
| 3/4" | H-62703W | 10/100 | \$22.52 | H-62703W-B | 12/48 | \$22.52 |
| 1" | H-62704W | 5/50 | \$35.89 | H-62704W-B | 6/24 | \$35.89 |



EXCLUSIVELY FOR



aquatherm



PRO-CONNECT PP-R PRO BALL VALVE

Full Port Forged Brass Ball Valve w/ Adjustable Packing Gland

LEAD-FREE BRASS

Certified to NSF/ANSI 61 & 372

| SIZE | SOCKET I.D. | ITEM# | CTN/CASE | LIST PRICE |
|------|-------------|-------|----------|------------|
|------|-------------|-------|----------|------------|

Female PP-R Metric Socket 355 PSI*

| | | | | |
|--------|-------|----------|------|----------|
| 1/2" | 20 mm | H-91702W | 5/50 | \$24.56 |
| 3/4" | 25 mm | H-91703W | 5/40 | \$35.49 |
| 1" | 32 mm | H-91704W | 4/20 | \$54.41 |
| 1 1/4" | 40 mm | H-91705W | 5/20 | \$85.50 |
| 1 1/2" | 50 mm | H-91706W | 4/16 | \$123.60 |
| 2" | 63 mm | H-91707W | 2/8 | \$180.50 |

Female PP-R Metric Socket x FIP 355 PSI*

| | | | | |
|--------|-------|----------|------|----------|
| 1/2" | 20 mm | H-94702W | 5/50 | \$24.56 |
| 3/4" | 25 mm | H-94703W | 5/40 | \$35.49 |
| 1" | 32 mm | H-94704W | 4/20 | \$54.41 |
| 1 1/4" | 40 mm | H-94705W | 5/20 | \$85.50 |
| 1 1/2" | 50 mm | H-94706W | 4/16 | \$123.60 |
| 2" | 63 mm | H-94707W | 2/8 | \$180.50 |

*OVERALL VALVE PRESSURE RATING AT 73° F. FURTHER RESTRICTIONS DETERMINED BY INTENDED OPERATING CONDITIONS AND LIMITATIONS SPECIFIC TO THE SYSTEM DESIGN. MAXIMUM PRESSURE RATING FOR SEAT & BODY ALONE IS 600 PSI.



PRO-CONNECT PP-R PRO BALL VALVE

Full Port Forged Brass Ball Valve w/ Adjustable Packing Gland

LEAD-FREE BRASS

Certified to NSF/ANSI 61 & 372

| SIZE | SOCKET I.D. | ITEM# | CTN/CASE | LIST PRICE |
|------|-------------|-------|----------|------------|
|------|-------------|-------|----------|------------|

Female PP-RCT Metric Socket 600 PSI*

| | | | | |
|--------|-------|-----------|------|----------|
| 1/2" | 20 mm | H-101702W | 5/50 | \$24.56 |
| 3/4" | 25 mm | H-101703W | 5/40 | \$35.49 |
| 1" | 32 mm | H-101704W | 4/20 | \$54.41 |
| 1 1/4" | 40 mm | H-101705W | 5/20 | \$85.50 |
| 1 1/2" | 50 mm | H-101706W | 4/16 | \$123.60 |
| 2" | 63 mm | H-101707W | 2/8 | \$180.50 |

Female PP-RCT Metric Socket x FIP 600 PSI*

| | | | | |
|--------|-------|-----------|------|----------|
| 1/2" | 20 mm | H-104702W | 5/50 | \$24.56 |
| 3/4" | 25 mm | H-104703W | 5/40 | \$35.49 |
| 1" | 32 mm | H-104704W | 4/20 | \$54.41 |
| 1 1/4" | 40 mm | H-104705W | 5/20 | \$85.50 |
| 1 1/2" | 50 mm | H-104706W | 4/16 | \$123.60 |
| 2" | 63 mm | H-104707W | 2/8 | \$180.50 |

*VALVE SEAT/BODY MAXIMUM PRESSURE RATING AT 100° F. OVERALL VALVE PRESSURE RATING IS DETERMINED BY INTENDED OPERATING CONDITIONS AND LIMITATIONS SPECIFIC TO THE SYSTEM DESIGN.



FULL FLOW FORGED BRASS BALL VALVE

w/ Stainless Steel Wing Style "T" Handle & Adjustable Packing Gland

LEAD-FREE BRASS

Certified to NSF/ANSI 61 & 372, NSF/ANSI-14 & IAPMO/ANSI Z1157

| SIZE | ITEM # | CTN/CASE | LIST PRICE |
|------|--------|----------|------------|
|------|--------|----------|------------|

ASTM F1960 PEX 400 WOG

| | | | |
|------|-------------|-------|---------|
| 1/2" | H-31702WSSW | 10/80 | \$9.80 |
| 3/4" | H-31703WSSW | 10/60 | \$15.13 |
| 1" | H-31704WSSW | 6/36 | \$23.60 |

ASTM F1960 PEX x FIP 400 WOG

| | | | |
|------|-------------|-------|---------|
| 1/2" | H-34702WSSW | 10/80 | \$9.80 |
| 3/4" | H-34703WSSW | 10/60 | \$15.13 |
| 1" | H-34704WSSW | 6/36 | \$23.60 |

BALL VALVES

FORGED BRASS BALL VALVE

w/ Bleeder, Reversible Handle & Adjustable Packing Gland

LEAD-FREE BRASS

Certified to NSF/ANSI 61-G

| SIZE | ITEM # | CTN/CASE | LIST PRICE |
|-----------------|----------|----------|------------|
| 600 WOG/150 WSP | | | |
| 1/2" | H-40622W | 15/120 | \$13.79 |
| 3/4" | H-40623W | 12/48 | \$19.89 |
| 1" | H-40624W | 8/32 | \$31.16 |
| 600 WOG/150 WSP | | | |
| 1/2" | H-50622W | 25/100 | \$13.79 |
| 3/4" | H-50623W | 10/40 | \$19.89 |
| 1" | H-50624W | 6/24 | \$31.16 |

FULL PORT FORGED BRASS BALL VALVE

w/ Cap & Strap, Reversible Handle & Adjustable Packing Gland

LEAD-FREE BRASS

Certified to NSF/ANSI 61-G

| SIZE | ITEM # | CTN/CASE | LIST PRICE |
|-----------------|----------|----------|------------|
| 600 WOG/150 WSP | | | |
| FIP × Hose | | | |
| 1/2" × 3/4" | H-40312W | 10/60 | \$14.77 |
| 3/4" | H-40313W | 10/60 | \$20.19 |
| 600 WOG/150 WSP | | | |
| SWT × Hose | | | |
| 1/2" × 3/4" | H-50312W | 10/100 | \$14.77 |
| 3/4" | H-50313W | 10/60 | \$20.19 |

LEAD-FREE BRASS

Certified to NSF/ANSI 61 & 372

| SIZE | ITEM # | CTN/CASE | LIST PRICE |
|-------------------|----------|----------|------------|
| 250 CWP/250 F Max | | | |
| Press × Hose | | | |
| 1/2" × 3/4" | H-80312W | 5/50 | \$31.95 |
| 3/4" | H-80313W | 5/40 | \$40.67 |

FORGED BRASS BALL VALVE

w/ Compression Ends & Adjustable Packing Gland

LEAD-FREE BRASS

Certified to NSF/ANSI 61-G

| SIZE | ITEM # | CTN/CASE | LIST PRICE |
|-----------------|----------|----------|------------|
| 600 WOG/150 WSP | | | |
| Compression | | | |
| 1/2" | H-40632W | 25/100 | \$15.81 |
| 3/4" | H-40633W | 15/60 | \$24.41 |
| 1" | H-40634W | 10/40 | \$37.75 |

FULL PORT FORGED BRASS BALL VALVE

w/ 1/4" Threaded Gauge Hole (Plugged), Reversible Handle & Adjustable Packing Gland

STANDARD BRASS

| SIZE | ITEM # | CTN/CASE | LIST PRICE |
|-----------------|---------|----------|------------|
| 600 WOG/150 WSP | | | |
| FIP | | | |
| 1/2" | H-41722 | 10/80 | \$11.84 |
| 3/4" | H-41723 | 10/60 | \$15.99 |
| 1" | H-41724 | 6/48 | \$24.14 |
| 1 1/4" | H-41725 | 4/32 | \$37.54 |
| 1 1/2" | H-41726 | 2/24 | \$57.89 |
| 2" | H-41727 | 2/16 | \$82.37 |

FULL PORT FORGED BRASS BALL VALVE

w/ Reversible Handle & Adjustable Packing Gland

LEAD-FREE BRASS

| SIZE | ITEM # | CTN/CASE | LIST PRICE |
|-----------------|----------|----------|------------|
| 600 WOG/150 WSP | | | |
| MIP × FIP | | | |
| 1/4" | H-40530W | 12/96 | \$8.47 |
| 3/8" | H-40531W | 12/96 | \$8.47 |
| 1/2" | H-40532W | 12/96 | \$11.81 |
| 3/4" | H-40533W | 10/60 | \$17.16 |
| 1" | H-40534W | 6/48 | \$27.63 |

FORGED BRASS HOSE BIBB

w/ Ball Valve Action

LEAD-FREE BRASS

Certified to NSF/ANSI 61-G

| SIZE | ITEM # | CTN/CASE | LIST PRICE |
|------------|----------|----------|------------|
| 125 WOG | | | |
| MIP × Hose | | | |
| 1/2" | H-30314W | 12/72 | \$11.84 |
| 3/4" | H-30316W | 12/72 | \$13.28 |

1/2" MIP OR SWT × HOSE

FULL FLOW FORGED NICKEL PLATED BRASS SILLCOCK

1/4 Turn Action w/ Stainless Steel Lever Handle

LEAD-FREE BRASS

| SIZE | ITEM # | CTN/CASE | LIST PRICE |
|---------------------------|-------------|----------|------------|
| 125 WOG | | | |
| ASTM F1960 PEX × MIP Hose | | | |
| 1/2" | H-33202WSSL | 12/72 | \$14.74 |

FULL PORT FORGED BRASS BALL VALVE

3 Way L-Port w/ Reversible Handle & Adjustable Packing Gland

STANDARD BRASS

| SIZE | ITEM # | CTN/CASE | LIST PRICE |
|-----------------|---------|----------|------------|
| 600 WOG/150 WSP | | | |
| FIP | | | |
| 1/2" | H-40642 | 15/60 | \$12.55 |
| 3/4" | H-40643 | 10/40 | \$18.67 |
| 1" | H-40644 | 6/24 | \$31.42 |

FULL PORT NICKEL PLATED FORGED BRASS BALL VALVE

w/ 304 Stainless Steel Lever Handle & Adjustable Packing Gland

LEAD-FREE BRASS

Certified to NSF/ANSI 61-G

| SIZE | ITEM # | CTN/CASE | LIST PRICE |
|-----------------|----------|----------|------------|
| 600 WOG/150 WSP | | | |
| FIP | | | |
| 1/4" | H-40800W | 20/120 | \$9.49 |
| 3/8" | H-40801W | 20/120 | \$9.49 |
| 1/2" | H-40802W | 20/120 | \$11.18 |
| 3/4" | H-40803W | 14/84 | \$16.39 |
| 1" | H-40804W | 8/48 | \$27.20 |
| 1 1/4" | H-40805W | 6/36 | \$36.86 |
| 1 1/2" | H-40806W | 4/24 | \$59.25 |
| 2" | H-40807W | 2/16 | \$85.39 |

STANDARD PORT FORGED BRASS BALL VALVE

w/ Adjustable Packing Gland

STANDARD BRASS

LEAD-FREE BRASS

Certified to NSF/ANSI 61-G

| SIZE | ITEM # | CTN/CASE | LIST PRICE | ITEM # | CTN/CASE | LIST PRICE |
|-----------------|---------|----------|------------|----------|----------|------------|
| 600 WOG/125 WSP | | | | | | |
| FIP | | | | | | |
| 1/4" | H-41820 | 10/120 | \$6.78 | H-41820W | 10/120 | \$8.20 |
| 3/8" | H-41821 | 10/120 | \$6.78 | H-41821W | 10/120 | \$8.20 |
| 1/2" | H-41822 | 10/120 | \$7.39 | H-41822W | 10/120 | \$8.30 |
| 3/4" | H-41823 | 10/80 | \$9.49 | H-41823W | 10/80 | \$10.68 |
| 1" | H-41824 | 6/48 | \$17.33 | H-41824W | 6/48 | \$20.54 |
| 1 1/4" | H-41825 | 4/32 | \$23.73 | H-41825W | 4/32 | \$29.65 |
| 1 1/2" | H-41826 | 2/24 | \$35.06 | H-41826W | 2/24 | \$43.01 |
| 2" | H-41827 | 2/16 | \$50.44 | H-41827W | 2/16 | \$63.88 |
| 2 1/2" | H-41828 | 2/4 | \$110.40 | H-41828W | 2/4 | \$135.30 |
| 3" | H-41829 | 1/3 | \$165.30 | H-41829W | 1/3 | \$207.40 |
| 4" | H-41830 | 1/2 | \$270.70 | H-41830W | 1/2 | \$328.20 |

FULL FLOW FORGED BRASS BALL VALVE

w/ Wing Handle

STANDARD BRASS

| SIZE | ITEM # | CTN/CASE | LIST PRICE |
|----------------------|---------|----------|------------|
| 160 WOG | | | |
| ASTM F1807 PEX × SWT | | | |
| 1/2" | H-50682 | 10/100 | \$8.25 |

FORGED BRASS SILLCOCK

Nickel Plated w/ 1/4 Turn Handle

LEAD-FREE BRASS

| SIZE | ITEM # | CTN/CASE | LIST PRICE |
|-------------------|----------|----------|------------|
| 125 WOG | | | |
| FIP Flange × Hose | | | |
| 1/2" | H-30202W | 12/72 | \$12.55 |
| 3/4" | H-30203W | 12/72 | \$16.89 |

BRASS HOSE BIBB

No Kink w/ 1/4 Turn Handle

LEAD-FREE BRASS

Certified to NSF/ANSI 61-G

| SIZE | ITEM # | CTN/CASE | LIST PRICE |
|------------|----------|----------|------------|
| 125 WOG | | | |
| MIP × Hose | | | |
| 1/2" | H-30218W | 12/72 | \$7.34 |
| 3/4" | H-30219W | 12/72 | \$8.04 |

1/2" MIP OR SWT × HOSE

STAINLESS STEEL BALL VALVES



FULL PORT 316 STAINLESS STEEL BALL VALVE
Seal Welded w/ 304 Stainless Steel Locking Handle & Adjustable Packing Gland

| SIZE | ITEM # | CTN/CASE | LIST PRICE |
|----------|---------|----------|------------|
| 2000 WOG | | | |
| 1/4" | H-43710 | 12/48 | \$36.56 |
| 1/2" | H-43712 | 10/60 | \$37.64 |
| 3/4" | H-43713 | 2/40 | \$46.17 |
| 1" | H-43714 | 6/18 | \$72.50 |
| 2" | H-43717 | 2/6 | \$212.50 |



STANDARD PORT 316 STAINLESS STEEL BALL VALVE
1 Piece Investment Cast w/ 304 Stainless Steel Locking Handle & Adjustable Packing Gland

| SIZE | ITEM # | CTN/CASE | LIST PRICE |
|------------------|---------|----------|------------|
| 1000 WOG/150 WSP | | | |
| 1/4" | H-43900 | 4/200 | \$21.96 |
| 3/8" | H-43901 | 4/200 | \$21.96 |
| 1/2" | H-43902 | 2/100 | \$21.96 |
| 3/4" | H-43903 | 2/80 | \$28.38 |
| 1" | H-43904 | 2/50 | \$40.03 |
| 1 1/4" | H-43905 | 2/40 | \$61.32 |
| 1 1/2" | H-43906 | 2/30 | \$75.75 |
| 2" | H-43907 | 2/30 | \$103.70 |



STANDARD PORT 316 STAINLESS STEEL BALL VALVE
Seal Welded w/ 304 Stainless Steel Locking Handle & Adjustable Packing Gland

| SIZE | ITEM # | CTN/CASE | LIST PRICE |
|----------|---------|----------|------------|
| 2000 WOG | | | |
| 1" | H-43814 | 9/27 | \$87.02 |
| 2" | H-43817 | 2/8 | \$222.60 |



FULL PORT 316 STAINLESS STEEL BALL VALVE
3 Piece Investment Cast w/ 304 Stainless Steel Locking Handle & Adjustable Packing Gland

| SIZE | ITEM # | CTN/CASE | LIST PRICE |
|------------------|---------|----------|------------|
| 1000 WOG/150 WSP | | | |
| 1/2" | H-43702 | 2/50 | \$40.17 |
| 3/4" | H-43703 | 2/40 | \$57.98 |
| 1" | H-43704 | 2/30 | \$75.69 |
| 1 1/4" | H-43705 | 2/16 | \$115.10 |
| 1 1/2" | H-43706 | 2/10 | \$155.80 |
| 2" | H-43707 | 2/8 | \$232.70 |



FULL PORT 316 STAINLESS STEEL BALL VALVE
2 Piece Investment Cast w/ 304 Stainless Steel Locking Handle & Adjustable Packing Gland

| SIZE | ITEM # | CTN/CASE | LIST PRICE |
|------------------|---------|----------|------------|
| 1000 WOG/150 WSP | | | |
| 1/4" | H-43720 | 2/80 | \$28.84 |
| 3/8" | H-43721 | 2/80 | \$28.84 |
| 1/2" | H-43722 | 2/60 | \$28.84 |
| 3/4" | H-43723 | 2/40 | \$39.08 |
| 1" | H-43724 | 2/40 | \$59.50 |
| 1 1/4" | H-43725 | 2/30 | \$84.04 |
| 1 1/2" | H-43726 | 2/16 | \$118.10 |
| 2" | H-43727 | 2/10 | \$182.50 |



W/ 304 STAINLESS STEEL OVAL HANDLE

| SIZE | ITEM # | CTN/CASE | LIST PRICE |
|------|------------|----------|------------|
| 1/2" | H-43722-OH | 1/40 | \$40.07 |
| 3/4" | H-43723-OH | 1/30 | \$56.29 |
| 1" | H-43724-OH | 1/20 | \$75.52 |

GAS BALL VALVES



FORGED BRASS GAS BALL VALVE

| STANDARD BRASS | | | |
|----------------|---------|----------|------------|
| SIZE | ITEM # | CTN/CASE | LIST PRICE |
| 1/2 TO 175 WOG | | | |
| 3/8" | H-22561 | 12/144 | \$5.01 |
| 1/2" | H-22562 | 12/144 | \$6.28 |
| 3/4" | H-22563 | 12/144 | \$8.80 |
| 1" | H-22564 | 6/72 | \$19.03 |

| STANDARD BRASS | | | |
|----------------|---------|----------|------------|
| SIZE | ITEM # | CTN/CASE | LIST PRICE |
| 1/2 TO 175 WOG | | | |
| Flare x FIP | | | |
| 3/8" x 1/2" | H-22521 | 10/120 | \$12.96 |
| 1/2" | H-22522 | 10/120 | \$8.47 |
| 5/8" x 3/4" | H-21526 | 6/96 | \$16.21 |

| STANDARD BRASS | | | |
|----------------|---------|----------|------------|
| SIZE | ITEM # | CTN/CASE | LIST PRICE |
| 1/2 TO 175 WOG | | | |
| Flare | | | |
| 3/8" | H-21550 | 12/144 | \$11.38 |
| 1/2" | H-21551 | 12/144 | \$11.38 |

CERTIFICATIONS DO NOT APPLY TO 21550

| STANDARD BRASS | | | |
|----------------|---------|----------|------------|
| SIZE | ITEM # | CTN/CASE | LIST PRICE |
| 1/2 TO 175 WOG | | | |
| Flare x MIP | | | |
| 3/8" x 1/2" | H-21571 | 12/144 | \$11.38 |
| 1/2" | H-21572 | 12/144 | \$11.38 |

PVC & CPVC BALL VALVES



FULL PORT PVC BALL VALVE
Fits Schedule 40 & 80 Pipe

| SIZE | ITEM # | CTN/CASE | LIST PRICE |
|--|---------|----------|------------|
| 230 PSI @ 73.4 F (6" 230 PSI @ 73.4 F) | | | |
| Socket Ends | | | |
| 1/2" | H-03822 | 1/195 | \$1.72 |
| 3/4" | H-03823 | 1/120 | \$2.48 |
| 1" | H-03824 | 1/83 | \$3.95 |
| 1 1/4" | H-03825 | 1/56 | \$5.62 |
| 1 1/2" | H-03826 | 1/12 | \$7.54 |
| 2" | H-03827 | 1/25 | \$12.90 |
| 2 1/2" | H-03828 | 1/16 | \$32.03 |
| 3" | H-03829 | 1/6 | \$44.43 |
| 4" | H-03830 | 1/6 | \$94.72 |
| 6" | H-03831 | 1/1 | \$308.60 |



FULL PORT CPVC BALL VALVE
Fits Schedule 40 & 80 CPVC Tubing

| SIZE | ITEM # | CTN/CASE | LIST PRICE |
|--|---------|----------|------------|
| 230 PSI @ 73.4 F | | | |
| FIP | | | |
| 1/2" | H-03922 | 1/195 | \$1.97 |
| 3/4" | H-03923 | 1/120 | \$2.48 |
| 1" | H-03924 | 1/83 | \$3.95 |
| 1 1/4" | H-03925 | 1/12 | \$5.76 |
| 1 1/2" | H-03926 | 1/36 | \$8.04 |
| 2" | H-03927 | 1/25 | \$12.35 |
| True Union (Includes FIP & Socket Ends) 230 PSI @ 73.4 F | | | |
| 1/2" | H-04602 | 1/72 | \$4.45 |
| 3/4" | H-04603 | 1/60 | \$7.04 |
| 1" | H-04604 | 1/24 | \$8.70 |
| 1 1/4" | H-04605 | 1/12 | \$14.22 |
| 1 1/2" | H-04606 | 1/12 | \$21.05 |
| 2" | H-04607 | 1/12 | \$32.76 |



FULL PORT CPVC BALL VALVE
Fits Schedule 40 & 80 CPVC Tubing

| SIZE | ITEM # | CTN/CASE | LIST PRICE |
|-----------------|---------|----------|------------|
| 230 PSI @ 194 F | | | |
| Socket Ends | | | |
| 1/2" | H-03722 | 1/100 | \$8.15 |
| 3/4" | H-03723 | 1/100 | \$9.74 |
| 1" | H-03724 | 1/100 | \$14.37 |
| 1 1/4" | H-03725 | 1/100 | \$19.89 |
| 1 1/2" | H-03726 | 1/48 | \$24.03 |
| 2" | H-03727 | 1/24 | \$38.58 |



MINI BALL VALVES



CHROME PLATED EXTRUDED BRASS MINI BALL VALVE
Hex Body

| STANDARD BRASS | | | |
|-------------------|---------|----------|------------|
| SIZE | ITEM # | CTN/CASE | LIST PRICE |
| 110 WOG NON SHOCK | | | |
| MIP x FIP | | | |
| 1/8" | H-40790 | 50/300 | \$6.88 |
| 1/4" | H-40791 | 50/300 | \$6.88 |
| 3/8" | H-40792 | 50/300 | \$6.88 |
| 1/2" | H-40798 | 30/300 | \$6.88 |
| 110 WOG NON SHOCK | | | |
| FIP | | | |
| 1/8" | H-40793 | 12/144 | \$6.88 |
| 1/4" | H-40794 | 50/400 | \$6.88 |
| 3/8" | H-40795 | 50/300 | \$6.88 |
| 1/2" | H-40796 | 5/500 | \$7.90 |
| 110 WOG NON-SHOCK | | | |
| ASTM F1807 PEX | | | |
| 1/2" | H-40782 | 12/144 | \$6.12 |

FULL PORT FORGED BRASS BALL VALVE
Pet Cock Style

| STANDARD BRASS | | | |
|-----------------|---------|----------|------------|
| SIZE | ITEM # | CTN/CASE | LIST PRICE |
| 600 WOG/125 WSP | | | |
| FIP x MIP | | | |
| 1/8" | H-41685 | 10/100 | \$5.80 |
| 1/4" x 1/8" | H-41686 | 10/100 | \$5.80 |
| 1/4" | H-41687 | 10/100 | \$5.80 |
| 600 WOG/125 WSP | | | |
| FIP | | | |
| 1/8" | H-41698 | 10/100 | \$5.80 |
| 1/4" | H-41699 | 10/100 | \$5.80 |

PEX PRODUCTS

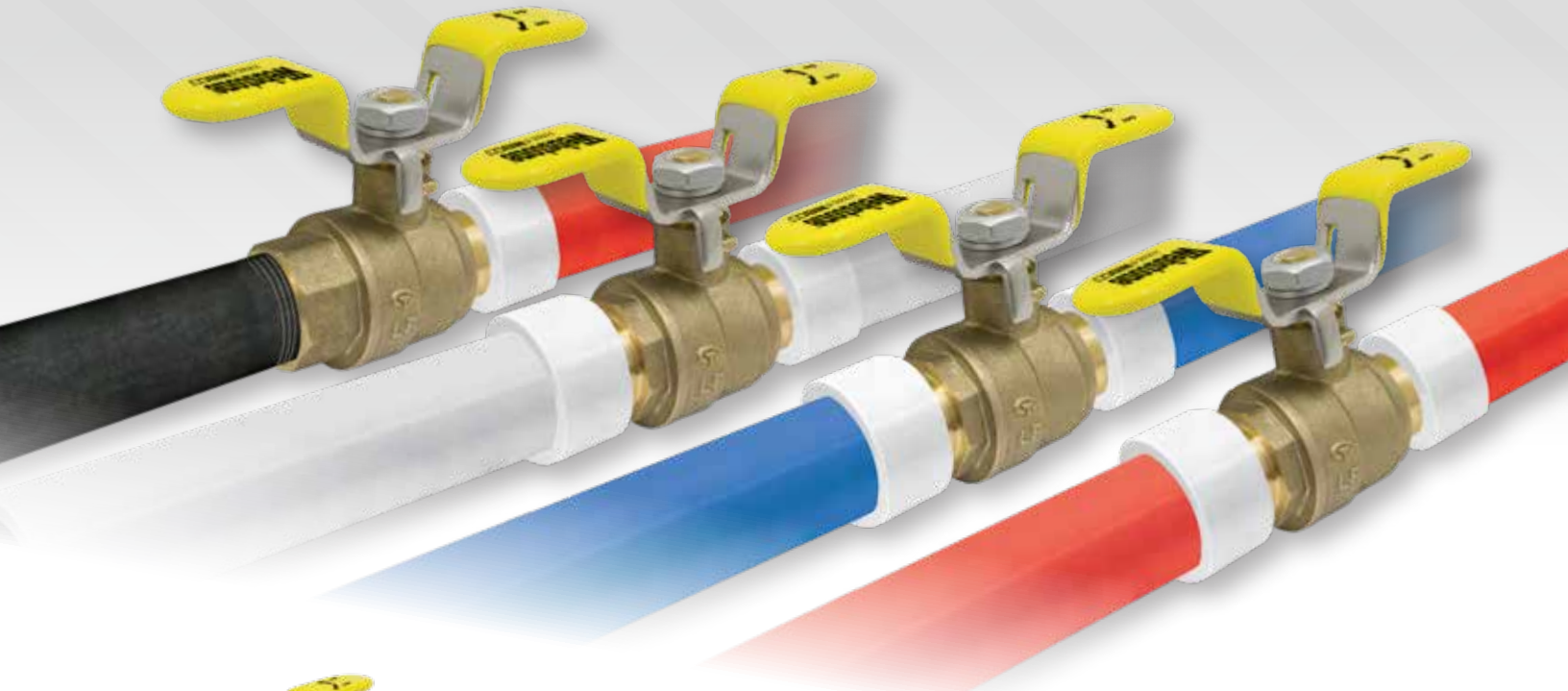

FULL FLOW FORGED BRASS BALL VALVE
w/ Stainless Steel Wing Style "T" Handle
& Adjustable Packing Gland

LEAD-FREE BRASS

Certified to NSF/ANSI 61 & 372,
NSF/ANSI-14 & IAPMO/ANSI Z1157

| SIZE | ITEM # | CTN/CASE | LIST PRICE |
|-----------------------------|-------------|----------|------------|
| ASTM F1960 PEX | | | |
| 1/2" | H-31702WSSW | 10/80 | \$9.80 |
| 3/4" | H-31703WSSW | 10/60 | \$15.13 |
| 1" | H-31704WSSW | 6/36 | \$23.60 |
| ASTM F1960 PEX x FIP | | | |
| 1/2" | H-34702WSSW | 10/80 | \$9.80 |
| 3/4" | H-34703WSSW | 10/60 | \$15.13 |
| 1" | H-34704WSSW | 6/36 | \$23.60 |



FULL FLOW FORGED NICKEL PLATED BRASS SILLCOCK
1/4 Turn Action w/ Stainless Steel Lever Handle

LEAD-FREE BRASS

| SIZE | ITEM # | CTN/CASE | LIST PRICE |
|---|-------------|----------|------------|
| ASTM F1960 PEX Flange x MIP Hose | | | |
| 1/2" | H-33202WSSL | 12/72 | \$14.74 |

CHROME PLATED EXTRUDED BRASS MINI BALL VALVE
Hex Body

STANDARD BRASS

| SIZE | ITEM # | CTN/CASE | LIST PRICE |
|-----------------------|---------|----------|------------|
| ASTM F1807 PEX | | | |
| 1/2" | H-40782 | 12/144 | \$6.12 |



THERMOSTATIC MIXING VALVE

Forged Brass Valve · See Page 18 for application information · **Lead-Free**

OUTLET TEMPERATURE RANGE 95-131° F

Certified to NSF/ANSI 61 & 372,
Body (H-7000W) Certified
to ASSE 1017, CSA B125.3

OUTLET TEMPERATURE RANGE 95-120° F

Certified to NSF/ANSI 61 & 372,
Body (H-7000W) Certified
to ASSE 1017, CSA B125.3

| SIZE | ITEM # | CTN/CASE | LIST PRICE | ITEM # | CTN/CASE | LIST PRICE |
|-----------------------|-----------|----------|------------|--------------|----------|------------|
| ASTM F1807 PEX | | | | | | |
| 1/2" | H-71102W* | 1/10 | \$107.10 | H-71102W-CAN | 1/10 | \$107.10 |
| 3/4" | H-71103W* | 1/10 | \$113.50 | H-71103W-CAN | 1/10 | \$113.50 |

W/ INTEGRAL CHECK VALVE

| SIZE | ITEM # | CTN/CASE | LIST PRICE | ITEM # | CTN/CASE | LIST PRICE |
|-----------------------|-----------|----------|------------|--------------|----------|------------|
| ASTM F1807 PEX | | | | | | |
| 1/2" | H-71202W* | 1/10 | \$107.10 | H-71202W-CAN | 1/10 | \$107.10 |
| 3/4" | H-71203W* | 1/10 | \$113.50 | H-71203W-CAN | 1/10 | \$113.50 |

*NEW ITEM NUMBER - FORMERLY H-7310W AND H-7320W SERIES



FULL FLOW FORGED BRASS BALL VALVE
w/ Wing Handle

STANDARD BRASS

| SIZE | ITEM # | CTN/CASE | LIST PRICE |
|-----------------------------|---------|----------|------------|
| ASTM F1807 PEX x SWT | | | |
| 1/2" | H-50682 | 10/100 | \$8.25 |

PRO-CONNECT
PRO-PUSH™

**OVER 200 VALVES & FITTINGS DESIGNED
FOR USE WITH PEX, CPVC & COPPER
SEE PAGE 8-9**

RADIATOR VALVES

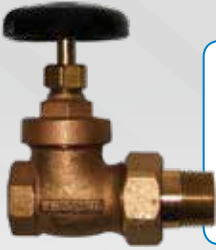

BRASS RADIATOR GATE VALVE

w/ Ground Joint Union Nut & Tailpiece

| STANDARD BRASS | | | |
|----------------|---------|----------|----------------|
| SIZE | ITEM # | CTN/CASE | LIST PRICE |
| FIP | | | 125 PSI/15 WSP |
| 3/4" | H-11523 | 6/60 | \$30.00 |
| 1" | H-11524 | 4/36 | \$44.57 |
| 1 1/4" | H-11525 | 2/24 | \$62.43 |
| 1 1/2" | H-11526 | 3/18 | \$79.68 |



BRASS BALANCING VALVE

w/ Butterfly Action & Screwdriver Slot

| STANDARD BRASS | | | |
|----------------|---------|----------|------------|
| SIZE | ITEM # | CTN/CASE | LIST PRICE |
| SWT | | | 125 PSI |
| 3/4" | H-20103 | 12/72 | \$8.04 |



BRASS PURGE & BALANCING VALVE

w/ Butterfly Action & Screwdriver Slot

| STANDARD BRASS | | | |
|------------------|---------|----------|------------|
| SIZE | ITEM # | CTN/CASE | LIST PRICE |
| SWT x SWT x Hose | | | 125 PSI |
| 3/4" | H-11603 | 12/72 | \$10.83 |

BRASS STEAM RADIATOR GLOBE VALVE

Angled w/ Ground Joint Nut & Tailpiece

| STANDARD BRASS | | | |
|----------------|---------|----------|---------------|
| SIZE | ITEM # | CTN/CASE | LIST PRICE |
| FIP | | | 60 PSI/15 WSP |
| 3/4" | H-11533 | 6/48 | \$23.17 |
| 1" | H-11534 | 4/36 | \$31.25 |
| 1 1/4" | H-11535 | 2/24 | \$42.63 |
| 1 1/2" | H-11536 | 2/16 | \$55.66 |



BRASS STEAM RADIATOR AIR VENT VALVE

Chrome Plated Float Type – Non Vacuum

| STANDARD BRASS | | | |
|-------------------------|-----------|----------|------------|
| SIZE | ITEM # | CTN/CASE | LIST PRICE |
| ANGLED | | | |
| MIP | | | 10 PSI |
| 1/8" | H-11511 | 12/72 | \$12.65 |
| STRAIGHT | | | |
| MIP | | | 10 PSI |
| 1/8" | H-11512 | 12/72 | \$11.79 |
| 1/4" | H-11513 | 12/72 | \$12.27 |
| ADJUSTABLE ANGLE | | | |
| MIP | | | 10 PSI |
| 1/8" | H-11515-A | 12/72 | \$13.36 |

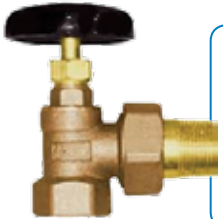

BRASS HOT WATER RADIATOR GLOBE VALVE

Angled w/ Ground Joint Union Nut & Tailpiece

| STANDARD BRASS | | | |
|----------------|---------|----------|------------|
| SIZE | ITEM # | CTN/CASE | LIST PRICE |
| FIP | | | 60 PSI |
| 3/4" | H-11553 | 6/60 | \$19.38 |
| 1" | H-11554 | 4/36 | \$32.13 |
| 1 1/4" | H-11555 | 2/24 | \$44.66 |
| 1 1/2" | H-11556 | 2/16 | \$57.93 |

BRASS UNION ELBOW & NUT FOR RADIATOR VALVE

Ground Joint Union Connection

| STANDARD BRASS | | | |
|----------------|-----------|----------|---------------|
| SIZE | ITEM # | CTN/CASE | LIST PRICE |
| FIP x MIP | | | 60 PSI/15 WSP |
| 3/4" | H-11533-E | 10/100 | \$12.96 |
| 1" | H-11534-E | 7/70 | \$20.19 |
| 1 1/4" | H-11535-E | 5/50 | \$30.30 |



FORGED BRASS AUTO STEAM VENT VALVE

Stainless Steel Check Ball & Spring

| STANDARD BRASS | | | |
|----------------|---------|----------|------------|
| SIZE | ITEM # | CTN/CASE | LIST PRICE |
| FIP | | | 125 PSI |
| 1/8" | H-11516 | 50/500 | \$11.38 |
| 1/4" | H-11517 | 50/500 | \$11.89 |



BRASS UNION TAILPIECE & NUT FOR RADIATOR VALVE

Ground Joint Nut & Tailpiece

| STANDARD BRASS | | | |
|----------------|-----------|----------|---------------|
| SIZE | ITEM # | CTN/CASE | LIST PRICE |
| FIP x MIP | | | 60 PSI/15 WSP |
| 3/4" | H-11533-T | 22/220 | \$3.21 |
| 1" | H-11534-T | 16/160 | \$4.56 |
| 1 1/4" | H-11535-T | 10/100 | \$6.96 |



BRASS TANK VALVE (GLOBE)

Hard Seat

| STANDARD BRASS | | | |
|----------------|---------|----------|------------|
| SIZE | ITEM # | CTN/CASE | LIST PRICE |
| MIP | | | 125 PSI |
| 1/2" x 3/8" | H-11401 | 6/72 | \$15.74 |
| MIP x Flare | | | 125 PSI |
| 1/2" x 3/8" | H-11403 | 6/72 | \$16.39 |



RADIATOR VALVE SPUD WRENCH

| SIZE | ITEM # | CTN/CASE | LIST PRICE |
|-----------|---------|----------|------------|
| 1/2 to 2" | H-25011 | 10/20 | \$18.42 |



BOILER DRAINS

BRASS BOILER DRAIN

| LEAD-FREE BRASS | | | |
|-----------------|----------|----------|------------|
| SIZE | ITEM # | CTN/CASE | LIST PRICE |
| MIP x Hose | | | 200 PSI |
| 1/2" | H-11702W | 12/72 | \$8.76 |
| 3/4" | H-11703W | 12/72 | \$9.26 |



BRASS WATER HEATER DRAIN VALVE

| LEAD-FREE BRASS | | | |
|-----------------|----------|----------|------------|
| SIZE | ITEM # | CTN/CASE | LIST PRICE |
| MIP x Hose | | | 125 PSI |
| 3/4" | H-11710W | 12/72 | \$12.55 |

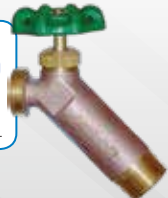

BRASS BOILER DRAIN

w/ Stuffing Box

| STANDARD BRASS | | | |
|----------------------|----------|----------|------------|
| SIZE | ITEM # | CTN/CASE | LIST PRICE |
| FIP x Hose | | | 200 PSI |
| 3/4" | H-11712 | 12/72 | \$7.04 |
| LEAD-FREE BRASS | | | |
| SIZE | ITEM # | CTN/CASE | LIST PRICE |
| MIP x Hose (Hi-Flow) | | | 200 PSI |
| 1/2" | H-11700W | 12/72 | \$11.33 |
| 3/4" | H-11701W | 12/72 | \$11.79 |
| MIP x Hose | | | 200 PSI |
| 1/2" | H-11704W | 12/72 | \$9.66 |
| 3/4" | H-11705W | 12/72 | \$10.43 |



BRASS WATER HEATER DRAIN VALVE

w/ Recirculating Elbow (Tan Handle)

| LEAD-FREE BRASS | | | |
|------------------|----------|----------|------------|
| SIZE | ITEM # | CTN/CASE | LIST PRICE |
| FIP x FIP x Hose | | | 125 PSI |
| 3/4" | H-11711W | 12/72 | \$13.10 |



CHECK VALVES



PRO-CONNECT PRO-PUSH IN-LINE SPRING CHECK VALVE
 Forged Dezincification Resistant Brass Fitting - For Connection to Copper, CPVC or PEX - **Lead-Free**

INDIVIDUALLY PACKED

Certified to NSF/ANSI 61-G, ASSE 1061

BULK PACKED

Certified to NSF/ANSI 61-G, ASSE 1061

| SIZE | ITEM # | CTN/CASE | LIST PRICE | ITEM # | BOX/CASE | LIST PRICE |
|------|----------|----------|------------|------------|-------------------|------------|
| Push | | | | | 200 PSI/200 F Max | |
| 1/2" | | | | H-26992W-B | 6/120 | \$20.39 |
| 3/4" | H-26993W | 12/120 | \$23.18 | H-26993W-B | 6/72 | \$23.18 |
| 1" | | | | H-26994W-B | 3/45 | \$51.39 |



FORGED BRASS SWING CHECK VALVE

Hard Seat

LEAD-FREE BRASS

Certified to NSF/ANSI 61

| SIZE | ITEM # | CTN/CASE | LIST PRICE |
|--------|----------|----------|-----------------|
| FIP | | | 200 WOG/125 WSP |
| 1/4" | H-10540W | 12/120 | \$6.02 |
| 3/8" | H-10541W | 10/120 | \$6.02 |
| 1/2" | H-10542W | 10/120 | \$10.07 |
| 3/4" | H-10543W | 10/80 | \$14.72 |
| 1" | H-10544W | 5/60 | \$21.13 |
| 1 1/4" | H-10545W | 5/40 | \$35.06 |
| 1 1/2" | H-10546W | 5/30 | \$47.10 |
| 2" | H-10547W | 2/12 | \$71.69 |
| 2 1/2" | H-10548W | 2/8 | \$121.10 |
| 3" | H-10549W | 1/8 | \$201.90 |
| 4" | H-10550W | 1/4 | \$323.80 |
| SWT | | | 200 WOG/125 WSP |
| 1/2" | H-10622W | 10/120 | \$10.07 |
| 3/4" | H-10623W | 10/80 | \$14.72 |
| 1" | H-10624W | 5/60 | \$21.13 |
| 1 1/4" | H-10625W | 5/40 | \$35.06 |
| 1 1/2" | H-10626W | 5/30 | \$47.10 |
| 2" | H-10627W | 2/10 | \$71.69 |

BRASS IN-LINE SPRING CHECK VALVE

316 Stainless Steel Spring - Soft Seat

LEAD-FREE BRASS

| SIZE | ITEM # | CTN/CASE | LIST PRICE |
|--------|----------|----------|------------|
| FIP | | | 300 PSI |
| 3/8" | H-10701W | 60/240 | \$13.28 |
| 1/2" | H-10702W | 10/100 | \$13.28 |
| 3/4" | H-10703W | 7/70 | \$17.07 |
| 1" | H-10704W | 5/50 | \$23.66 |
| 1 1/4" | H-10705W | 5/40 | \$35.97 |
| 1 1/2" | H-10706W | 5/30 | \$42.40 |
| 2" | H-10707W | 2/20 | \$82.22 |



B62 BRONZE (85-5-5-5) SWING CHECK VALVE

Hard Seat

| SIZE | ITEM # | CTN/CASE | LIST PRICE |
|--------|---------|----------|-----------------|
| FIP | | | 300 WOG/150 WSP |
| 3/8" | H-10501 | 10/120 | \$12.27 |
| 1/2" | H-10502 | 10/120 | \$12.27 |
| 3/4" | H-10503 | 10/80 | \$15.89 |
| 1" | H-10504 | 5/60 | \$21.96 |
| 1 1/4" | H-10505 | 5/40 | \$36.00 |
| 1 1/2" | H-10506 | 5/30 | \$45.41 |
| 2" | H-10507 | 2/24 | \$75.89 |
| 2 1/2" | H-10508 | 1/12 | \$131.50 |
| 3" | H-10509 | 1/8 | \$188.50 |
| 4" | H-10510 | 1/4 | \$301.00 |



FORGED BRASS SWING CHECK VALVE

Soft Seat

STANDARD BRASS

| SIZE | ITEM # | CTN/CASE | LIST PRICE |
|--------|---------|----------|-----------------|
| FIP | | | 200 WOG/125 WSP |
| 1/2" | H-10522 | 12/120 | \$10.12 |
| 3/4" | H-10523 | 10/80 | \$13.21 |
| 1" | H-10524 | 5/60 | \$17.61 |
| 1 1/4" | H-10525 | 5/40 | \$29.60 |
| 1 1/2" | H-10526 | 5/30 | \$37.84 |
| 2" | H-10527 | 2/24 | \$62.11 |

GATE VALVES

FORGED BRASS GATE VALVE

Hard Seat

STANDARD BRASS

| SIZE | ITEM # | CTN/CASE | LIST PRICE |
|--------|---------|----------|-----------------|
| FIP | | | 200 WOG/125 WSP |
| 2" | H-10137 | 2/20 | \$46.40 |
| 2 1/2" | H-10138 | 1/10 | \$85.89 |
| 3" | H-10139 | 1/10 | \$124.60 |
| 4" | H-10140 | 1/4 | \$204.90 |

CERTIFICATION APPLIES TO 2" ONLY

LEAD-FREE BRASS

Certified to NSF/ANSI 61-G

| SIZE | ITEM # | CTN/CASE | LIST PRICE |
|--------|----------|----------|-----------------|
| FIP | | | 200 WOG/125 WSP |
| 1/2" | H-10132W | 10/100 | \$10.07 |
| 3/4" | H-10133W | 10/100 | \$14.04 |
| 1" | H-10134W | 5/50 | \$19.28 |
| 1 1/4" | H-10135W | 5/30 | \$33.55 |
| 1 1/2" | H-10136W | 2/30 | \$42.88 |
| 2" | H-10137W | 2/20 | \$58.14 |
| 2 1/2" | H-10138W | 1/10 | \$108.30 |
| 3" | H-10139W | 1/10 | \$158.10 |
| 4" | H-10140W | 1/4 | \$250.50 |



BRASS GLOBE VALVE

Straight - Hard Seat

STANDARD BRASS

| SIZE | ITEM # | CTN/CASE | LIST PRICE |
|--------|---------|----------|-----------------|
| FIP | | | 200 WOG/125 WSP |
| 1/4" | H-10400 | 10/120 | \$9.69 |
| 3/8" | H-10401 | 10/120 | \$9.69 |
| 1/2" | H-10402 | 10/120 | \$10.43 |
| 3/4" | H-10403 | 10/80 | \$13.73 |
| 1" | H-10404 | 5/40 | \$19.81 |
| 1 1/4" | H-10405 | 5/30 | \$28.89 |
| 1 1/2" | H-10406 | 4/24 | \$40.37 |
| 2" | H-10407 | 2/16 | \$61.96 |

HEAVY PATTERN BRONZE GATE VALVE

Hard Seat

| SIZE | ITEM # | CTN/CASE | LIST PRICE |
|--------|---------|----------|-----------------|
| FIP | | | 300 WOG/150 WSP |
| 1/2" | H-10102 | 10/100 | \$17.66 |
| 3/4" | H-10103 | 6/60 | \$26.41 |
| 1" | H-10104 | 5/40 | \$38.83 |
| 1 1/4" | H-10105 | 5/30 | \$54.03 |
| 1 1/2" | H-10106 | 4/24 | \$71.89 |
| 2" | H-10107 | 4/16 | \$102.50 |
| 2 1/2" | H-10108 | 2/8 | \$173.90 |
| 3" | H-10109 | 1/6 | \$266.40 |
| 4" | H-10110 | 1/4 | \$384.50 |



BRASS STOP VALVE (GLOBE)

Straight - Soft Seat

STANDARD BRASS

| SIZE | ITEM # | CTN/CASE | LIST PRICE |
|--------|---------|----------|------------|
| FIP | | | 125 WOG |
| 1/2" | H-11802 | 12/72 | \$8.90 |
| 3/4" | H-11803 | 12/72 | \$9.96 |
| 1" | H-11804 | 5/40 | \$20.11 |
| 1 1/4" | H-11805 | 5/30 | \$28.47 |
| 1 1/2" | H-11806 | 4/24 | \$39.92 |
| 2" | H-11807 | 2/16 | \$60.71 |

SILCOCKS

SUPPLY STOPS

AVAILABLE W/
**PRO-CONNECT
PROPUSH**
FOR COPPER,
PEX & CPVC
SEE PAGE 8



FULL FLOW FORGED NICKEL PLATED BRASS SILCOCK

1/4 Turn Action w/ Stainless Steel Lever Handle

| SIZE | ITEM # | CTN/CASE | LIST PRICE |
|----------------------------------|-------------|----------|------------|
| ASTM F1960 PEX Flange x MIP Hose | | | 125 WOG |
| 1/2" | H-33202WSSL | 12/72 | \$14.74 |



FORGED BRASS SILCOCK

Nickel Plated w/ 1/4 Turn Handle

| SIZE | ITEM # | CTN/CASE | LIST PRICE |
|-------------------|----------|----------|------------|
| FIP Flange x Hose | | | 125 WOG |
| 1/2" | H-30202W | 12/72 | \$12.55 |
| 3/4" | H-30203W | 12/72 | \$16.89 |



BRASS FROST FREE SILCOCK

Chrome Plated w/ Integral Vacuum Breaker

| SIZE | ITEM # | CTN/CASE | LIST PRICE |
|-----------------------|----------|----------|------------|
| 1/2 MIP or SWT x Hose | | | 125 WOG |
| 6" | H-11832W | 2/24 | \$32.76 |
| 8" | H-11834W | 2/24 | \$34.63 |
| 10" | H-11836W | 2/24 | \$37.19 |
| 12" | H-11838W | 2/24 | \$39.72 |
| 14" | H-11840W | 2/24 | \$41.11 |



1/4 TURN SUPPLY STOP

Chrome Plated Extruded Brass

| SIZE | ITEM # | CTN/CASE | LIST PRICE |
|--------------------------|----------|----------|------------|
| ANGLED | | | |
| FIP x Compression | | | |
| 3/8" | H-11900W | 20/120 | \$16.71 |
| 1/2" x 3/8" | H-11901W | 20/120 | \$17.31 |
| SWT x Compression | | | |
| 5/8" x 3/8" | H-11905W | 20/120 | \$16.45 |
| Compression | | | |
| 5/8" x 3/8" | H-11908W | 20/120 | \$19.16 |
| STRAIGHT | | | |
| FIP x Compression | | | |
| 3/8" | H-11940W | 20/120 | \$16.71 |
| 1/2" x 3/8" | H-11941W | 20/120 | \$17.31 |
| Compression | | | |
| 5/8" x 3/8" | H-11945W | 20/120 | \$16.45 |
| Compression | | | |
| 5/8" x 3/8" | H-11948W | 20/120 | \$19.16 |



SUPPLY STOP

Chrome Plated Extruded Brass – Celcon Stem

| SIZE | ITEM # | CTN/CASE | LIST PRICE |
|--------------------------|------------|----------|------------|
| ANGLED | | | |
| FIP x Compression | | | |
| 3/8" | H-11900W-C | 10/100 | \$10.98 |
| 1/2" x 3/8" | H-11901W-C | 10/100 | \$12.31 |
| Compression | | | |
| 5/8" x 3/8" | H-11908W-C | 10/100 | \$13.11 |
| STRAIGHT | | | |
| FIP x Compression | | | |
| 3/8" | H-11940W-C | 10/100 | \$10.98 |
| 1/2" x 3/8" | H-11941W-C | 10/100 | \$12.31 |
| Compression | | | |
| 5/8" x 3/8" | H-11948W-C | 10/100 | \$13.11 |



HOSE BIBBS

FORGED BRASS HOSE BIBB

w/ Ball Valve Action

| SIZE | ITEM # | CTN/CASE | LIST PRICE |
|------------|----------|----------|------------|
| MIP x Hose | | | 125 WOG |
| 1/2" | H-30314W | 12/72 | \$11.84 |
| 3/4" | H-30316W | 12/72 | \$13.28 |



BRASS HOSE BIBB

No Kink w/ 1/4 Turn Handle

| SIZE | ITEM # | CTN/CASE | LIST PRICE |
|------------|----------|----------|------------|
| MIP x Hose | | | 125 WOG |
| 1/2" | H-30218W | 12/72 | \$7.34 |
| 3/4" | H-30219W | 12/72 | \$8.04 |



BRASS GARDEN VALVE

Bent Nose w/ Oval Handle

| SIZE | ITEM # | CTN/CASE | LIST PRICE |
|------------|----------|----------|------------|
| FIP x Hose | | | 125 PSI |
| 3/4" | H-30213W | 12/72 | \$14.72 |
| 1" | H-30214W | 12/72 | \$15.49 |

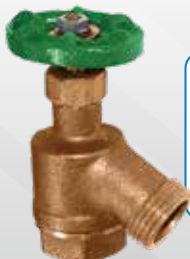

BRASS HOSE BIBB VACUUM BREAKER

Anti-Siphon Device w/ Flat Washer (CP = Chrome Plated)

| SIZE | ITEM # | CTN/CASE | LIST PRICE |
|------|-------------|----------|------------|
| Hose | | | 150 PSI |
| 3/4" | H-11850W | 12/144 | \$9.36 |
| 3/4" | H-11850W-CP | 12/144 | \$9.36 |



UNIONS

DIELECTRIC UNION

Galvanized Steel & Brass – w/ Nylon Insulator Ring

| SIZE | ITEM # | CTN/CASE | LIST PRICE |
|-------------|----------|----------|------------|
| FIP x SWT | | | 232 F Max |
| 1/2" | H-01102W | 24/144 | \$5.10 |
| 3/4" | H-01103W | 24/96 | \$6.84 |
| 1" | H-01104W | 12/96 | \$9.44 |
| 1 1/4" | H-01105W | 6/48 | \$13.21 |
| 1 1/2" | H-01106W | 6/36 | \$21.30 |
| 2" | H-01107W | 6/18 | \$34.30 |
| 3/4" x 1/2" | H-01132W | 24/96 | \$6.71 |



CPVC UNION

Fits CPVC Pipe (Copper Tubing Size)

| SIZE | ITEM # | CTN/CASE | LIST PRICE |
|-------------|---------|----------|------------|
| Socket Ends | | | |
| 1/2" | H-03742 | 16/96 | \$4.80 |
| 3/4" | H-03743 | 12/96 | \$6.24 |



CPVC UNION

Fits Schedule 40 & 80 Pipe – White

| SIZE | ITEM # | CTN/CASE | LIST PRICE |
|--------------------|---------|----------|------------|
| Socket Ends | | | |
| 1/2" | H-04822 | 1/320 | \$1.01 |
| 3/4" | H-04823 | 1/72 | \$1.65 |
| 1" | H-04824 | 1/126 | \$2.58 |
| 1 1/4" | H-04825 | 1/64 | \$3.66 |
| 1 1/2" | H-04826 | 1/36 | \$5.47 |
| 2" | H-04827 | 1/32 | \$9.44 |
| 2 1/2" | H-04828 | 1/12 | \$24.03 |
| 3" | H-04829 | 1/12 | \$26.44 |
| 4" | H-04830 | 1/8 | \$51.58 |
| FIP | | | |
| 1/2" | H-04832 | 1/320 | \$1.01 |
| 3/4" | H-04833 | 1/72 | \$1.65 |
| 1" | H-04834 | 1/60 | \$2.58 |
| 1 1/4" | H-04835 | 1/64 | \$3.66 |
| 1 1/2" | H-04836 | 1/48 | \$5.47 |
| 2" | H-04837 | 6/24 | \$9.44 |



INDEX

| PART NUMBER | PAGE | PART NUMBER | PAGE | PART NUMBER | PAGE | PART NUMBER | PAGE | PART NUMBER | PAGE |
|-------------|------|-------------|------|---------------|------|---------------|--------|---------------------------|------------|
| H-01102W | 26 | H-10543W | 25 | H-21572 | 22 | H-26407W-B | 9 | H-30314W | 21, 26 |
| H-01103W | 26 | H-10544W | 25 | H-22521 | 22 | H-26412W | 9 | H-30316W | 21, 26 |
| H-01104W | 26 | H-10545W | 25 | H-22522 | 22 | H-26412W-B | 9 | H-31000 | 19 |
| H-01105W | 26 | H-10546W | 25 | H-22561 | 22 | H-26412WHE-B | 9 | H-31702WSSW | 20, 23 |
| H-01106W | 26 | H-10547W | 25 | H-22562 | 22 | H-26413W-B | 9 | H-31703WSSW | 20, 23 |
| H-01107W | 26 | H-10548W | 25 | H-22563 | 22 | H-26421W-B | 9 | H-31704WSSW | 20, 23 |
| H-01132W | 26 | H-10549W | 25 | H-22564 | 22 | H-26422W | 9 | H-33202WSSL | 21, 23, 26 |
| H-03722 | 22 | H-10550W | 25 | H-25011 | 24 | H-26422W-B | 9 | H-34702WSSW | 20, 23 |
| H-03723 | 22 | H-10562 | 19 | H-26000WKIT | 9 | H-26432W | 9 | H-34703WSSW | 20, 23 |
| H-03724 | 22 | H-10563 | 19 | H-26023W-12-B | 8 | H-26432W-B | 9 | H-34704WSSW | 20, 23 |
| H-03725 | 22 | H-10564 | 19 | H-26023W-15-B | 8 | H-26443W-B | 9 | H-40312W | 21 |
| H-03726 | 22 | H-10565 | 19 | H-26023W-18 | 8 | H-26462W | 9 | H-40313W | 21 |
| H-03727 | 22 | H-10566 | 19 | H-26023W-18-B | 8 | H-26462W-B | 9 | H-40402/H-40402HV | 12 |
| H-03742 | 26 | H-10567 | 19 | H-26023W-24-B | 8 | H-26500W-B | 9 | H-40403/H-40403HV | 12 |
| H-03743 | 26 | H-10622W | 25 | H-26033W-12 | 8 | H-26501W-B | 9 | H-40404/H-40404HV | 12 |
| H-03822 | 22 | H-10623W | 25 | H-26033W-12-B | 8 | H-26502W | 9 | H-40405/H-40405HV | 12 |
| H-03823 | 22 | H-10624W | 25 | H-26033W-15 | 8 | H-26502W-B | 9 | H-40406/H-40406HV | 12 |
| H-03824 | 22 | H-10625W | 25 | H-26033W-15-B | 8 | H-26503W | 9 | H-40407HV | 12 |
| H-03825 | 22 | H-10626W | 25 | H-26033W-18 | 8 | H-26503W-B | 9 | H-40413/H-40413HV | 12 |
| H-03826 | 22 | H-10627W | 25 | H-26033W-18-B | 8 | H-26504W | 9 | H-40413KIT/H-40413HVKIT | 12 |
| H-03827 | 22 | H-10701W | 25 | H-26033W-24 | 8 | H-26504W-B | 9 | H-40414/H-40414HV | 12 |
| H-03828 | 22 | H-10702W | 25 | H-26033W-24-B | 8 | H-26505W-B | 9 | H-40414KIT/H-40414HVKIT | 12 |
| H-03829 | 22 | H-10703W | 25 | H-26100W-B | 9 | H-26506W-B | 9 | H-40415/H-40415HV | 12 |
| H-03830 | 22 | H-10704W | 25 | H-26101W | 9 | H-26507W-B | 9 | H-40415KIT/H-40415HVKIT | 12 |
| H-03831 | 22 | H-10705W | 25 | H-26101W-B | 9 | H-26512W-B | 9 | H-40416/H-40416HV | 12 |
| H-03922 | 22 | H-10706W | 25 | H-26102W | 9 | H-26520W-B | 9 | H-40417HV | 12 |
| H-03923 | 22 | H-10707W | 25 | H-26102W-B | 9 | H-26521W-B | 9 | H-40433 | 14 |
| H-03924 | 22 | H-11401 | 24 | H-26103W | 9 | H-26522W | 9 | H-40433W | 14 |
| H-03925 | 22 | H-11403 | 24 | H-26103W-B | 9 | H-26522W-B | 9 | H-40434 | 14 |
| H-03926 | 22 | H-11511 | 24 | H-26104W | 9 | H-26532W | 9 | H-40434W | 14 |
| H-03927 | 22 | H-11512 | 24 | H-26104W-B | 9 | H-26532W-B | 9 | H-40435 | 14 |
| H-04602 | 22 | H-11513 | 24 | H-26105W-B | 9 | H-26533W | 9 | H-40435W | 14 |
| H-04603 | 22 | H-11515-A | 24 | H-26106W-B | 9 | H-26533W-B | 9 | H-40436 | 14 |
| H-04604 | 22 | H-11516 | 24 | H-26107W-B | 9 | H-26543W | 9 | H-40436W | 14 |
| H-04605 | 22 | H-11517 | 24 | H-26112W | 9 | H-26543W-B | 9 | H-40443W | 16 |
| H-04606 | 22 | H-11523 | 24 | H-26112W-B | 9 | H-26601W-B | 9 | H-40443WCOM | 17 |
| H-04607 | 22 | H-11524 | 24 | H-26120W-B | 9 | H-26602W | 9 | H-40443WPR | 16 |
| H-04822 | 26 | H-11525 | 24 | H-26122W | 9 | H-26602W-B | 9 | H-40443WPR2 | 16 |
| H-04823 | 26 | H-11526 | 24 | H-26122W-B | 9 | H-26603W | 9 | H-40530W | 21 |
| H-04824 | 26 | H-11533 | 24 | H-26132W | 9 | H-26603W-B | 9 | H-40531W | 21 |
| H-04825 | 26 | H-11533-E | 24 | H-26132W-B | 9 | H-26604W | 9 | H-40532W | 21 |
| H-04826 | 26 | H-11533-T | 24 | H-26133W | 9 | H-26604W-B | 9 | H-40533W | 21 |
| H-04827 | 26 | H-11534 | 24 | H-26133W-B | 9 | H-26605W-B | 9 | H-40534W | 21 |
| H-04828 | 26 | H-11534-E | 24 | H-26143W | 9 | H-26606W-B | 9 | H-40612 | 14 |
| H-04829 | 26 | H-11534-T | 24 | H-26143W-B | 9 | H-26607W-B | 9 | H-40612W | 14 |
| H-04830 | 26 | H-11535 | 24 | H-26144W | 9 | H-26702W | 9 | H-40613 | 14 |
| H-04832 | 26 | H-11535-E | 24 | H-26144W-B | 9 | H-26702W-B | 9 | H-40613W | 14 |
| H-04833 | 26 | H-11535-T | 24 | H-26154W-B | 9 | H-26703W | 9 | H-40614 | 14 |
| H-04834 | 26 | H-11536 | 24 | H-26165W-B | 9 | H-26703W-B | 9 | H-40614W | 14 |
| H-04835 | 26 | H-11553 | 24 | H-26176W-B | 9 | H-26722W | 9 | H-40615 | 14 |
| H-04836 | 26 | H-11554 | 24 | H-26192W-B | 9 | H-26722W-B | 9 | H-40615W | 14 |
| H-04837 | 26 | H-11555 | 24 | H-26193W-B | 9 | H-26733W | 9 | H-40616 | 14 |
| H-10102 | 25 | H-11556 | 24 | H-26202W | 9 | H-26733W-B | 9 | H-40616W | 14 |
| H-10103 | 25 | H-11603 | 24 | H-26202W-B | 9 | H-26752W-B | 9 | H-40617 | 14 |
| H-10104 | 25 | H-11700W | 24 | H-26203W | 9 | H-26820W | 8 | H-40617W | 14 |
| H-10105 | 25 | H-11701W | 24 | H-26203W-B | 9 | H-26820W-B | 8 | H-40622W | 21 |
| H-10106 | 25 | H-11702W | 24 | H-26203WKIT | 8 | H-26821W | 8 | H-40623W | 21 |
| H-10107 | 25 | H-11703W | 24 | H-26203WKIT-B | 8 | H-26821W-B | 8 | H-40624W | 21 |
| H-10108 | 25 | H-11704W | 24 | H-26204W | 9 | H-26920W | 8 | H-40632W | 21 |
| H-10109 | 25 | H-11705W | 24 | H-26204W-B | 9 | H-26920W-B | 8 | H-40633W | 21 |
| H-10110 | 25 | H-11710W | 24 | H-26205W-B | 9 | H-26920WKIT-B | 8 | H-40634W | 21 |
| H-10132W | 25 | H-11711W | 24 | H-26206W-B | 9 | H-26921W | 8 | H-40642 | 21 |
| H-10133W | 25 | H-11712 | 24 | H-26207W-B | 9 | H-26921W-B | 8 | H-40643 | 21 |
| H-10134W | 25 | H-11802 | 25 | H-26212W-B | 9 | H-26921WKIT-B | 8 | H-40644 | 21 |
| H-10135W | 25 | H-11803 | 25 | H-26220W-B | 9 | H-26930WKIT-B | 8 | H-40782 | 22, 23 |
| H-10136W | 25 | H-11804 | 25 | H-26222W | 9 | H-26992W-B | 8, 25 | H-40790 | 22 |
| H-10137 | 25 | H-11805 | 25 | H-26222W-B | 9 | H-26993W | 8, 25 | H-40791 | 22 |
| H-10137W | 25 | H-11806 | 25 | H-26223W | 9 | H-26993W-B | 8, 25 | H-40792 | 22 |
| H-10138 | 25 | H-11807 | 25 | H-26223W-B | 9 | H-26994W-B | 8, 25 | H-40793 | 22 |
| H-10138W | 25 | H-11832W | 26 | H-26223WKIT | 8 | H-28000-B | 8 | H-40794 | 22 |
| H-10139 | 25 | H-11834W | 26 | H-26223WKIT-B | 8 | H-28023W | 17 | H-40795 | 22 |
| H-10139W | 25 | H-11836W | 26 | H-26232W-B | 9 | H-28110-B | 8 | H-40796 | 22 |
| H-10140 | 25 | H-11838W | 26 | H-26233W-B | 9 | H-28111-B | 8 | H-40798 | 22 |
| H-10140W | 25 | H-11840W | 26 | H-26234W-B | 9 | H-28112 | 8 | H-40800W | 21 |
| H-10400 | 25 | H-11850W | 26 | H-26302W | 9 | H-28112-B | 8 | H-40801W | 21 |
| H-10401 | 25 | H-11850W-CP | 26 | H-26302W-B | 9 | H-28113 | 8 | H-40802W | 21 |
| H-10402 | 25 | H-11900W | 26 | H-26303W | 9 | H-28113-B | 8 | H-40803W | 21 |
| H-10403 | 25 | H-11900W-C | 26 | H-26303W-B | 9 | H-28114 | 8 | H-40804W | 21 |
| H-10404 | 25 | H-11901W | 26 | H-26304W | 9 | H-28114-B | 8 | H-40805W | 21 |
| H-10405 | 25 | H-11901W-C | 26 | H-26304W-B | 9 | H-28115-B | 8 | H-40806W | 21 |
| H-10406 | 25 | H-11905W | 26 | H-26305W-B | 9 | H-28116-B | 8 | H-40807W | 21 |
| H-10407 | 25 | H-11908W | 26 | H-26306W-B | 9 | H-28117-B | 8 | H-41403/H-41403HV | 12 |
| H-10501 | 25 | H-11908W-C | 26 | H-26307W-B | 9 | H-28212 | 8 | H-41403W/H-41403WHV | 12 |
| H-10502 | 25 | H-11940W | 26 | H-26312W-B | 9 | H-28212-B | 8 | H-41404/H-41404HV | 12 |
| H-10503 | 25 | H-11940W-C | 26 | H-26320W-B | 9 | H-28213 | 8 | H-41404W/H-41404WHV | 12 |
| H-10504 | 25 | H-11941W | 26 | H-26323W | 9 | H-28213-B | 8 | H-41405/H-41405HV | 12 |
| H-10505 | 25 | H-11941W-C | 26 | H-26323W-B | 9 | H-28214 | 8 | H-41405W/H-41405WHV | 12 |
| H-10506 | 25 | H-11945W | 26 | H-26332W-B | 9 | H-28214-B | 8 | H-41406/H-41406HV | 12 |
| H-10507 | 25 | H-11948W | 26 | H-26334W-B | 9 | H-28215-B | 8 | H-41406HV-RF375 | 13 |
| H-10508 | 25 | H-11948W-C | 26 | H-26343W | 9 | H-28216-B | 8 | H-41406W/H-41406WHV | 12 |
| H-10509 | 25 | H-13703HV | 13 | H-26343W-B | 9 | H-28217-B | 8 | H-41407HV-RF400 | 13 |
| H-10510 | 25 | H-13706HV | 13 | H-26400W-B | 9 | H-29003 | 17 | H-41407HV-RF475 | 13 |
| H-10522 | 25 | H-20103 | 24 | H-26401W-B | 9 | H-29003W | 17 | H-41407WHV | 12 |
| H-10523 | 25 | H-20713 | 17 | H-26402W | 9 | H-30000W-P | 19 | H-41413/H-41413HV | 12 |
| H-10524 | 25 | H-20713W | 17 | H-26402W-B | 9 | H-30000W-TP | 19 | H-41413KIT/H-41413HVKIT | 12 |
| H-10525 | 25 | H-20723 | 17 | H-26403W | 9 | H-30202W | 21, 26 | H-41413W/H-41413WHV | 12 |
| H-10526 | 25 | H-20733 | 17 | H-26403W-B | 9 | H-30203W | 21, 26 | H-41413WKIT/H-41413WHVKIT | 12 |
| H-10527 | 25 | H-21526 | 22 | H-26404W | 9 | H-30213W | 26 | H-41414/H-41414HV | 12 |
| H-10540W | 25 | H-21550 | 22 | H-26404W-B | 9 | H-30214W | 26 | H-41414KIT/H-41414HVKIT | 12 |
| H-10541W | 25 | H-21551 | 22 | H-26405W-B | 9 | H-30218W | 21, 26 | H-41414W/H-41414WHV | 12 |
| H-10542W | 25 | H-21571 | 22 | H-26406W-B | 9 | H-30219W | 21, 26 | H-41414WKIT/H-41414WHVKIT | 12 |

INDEX

| PART NUMBER | PAGE | PART NUMBER | PAGE | PART NUMBER | PAGE | PART NUMBER | PAGE | PART NUMBER | PAGE |
|---------------------------|------|-------------------------|--------|---------------------------|-------|-----------------|--------|-----------------|-------|
| H-41415/H-41415HV | 12 | H-43717 | 22 | H-51407HV-RF475 | 13 | H-64443WPR-LF | 16 | H-81417HV | 4, 12 |
| H-41415KIT/H-41415HVKIT | 12 | H-43720 | 22 | H-51407WHV | 12 | H-65443WPR | 16 | H-81417HV-RF400 | 4, 13 |
| H-41415WHV/H-41415WHV | 12 | H-43721 | 22 | H-51413/H-51413HV | 12 | H-65443WPR-LF | 16 | H-81417HV-RF475 | 4, 13 |
| H-41415WKIT/H-41415WHVKIT | 12 | H-43722 | 22 | H-51413KIT/H-51413HVKIT | 12 | H-71102W | 18, 23 | H-81424HV | 4, 13 |
| H-41416/H-41416HV | 12 | H-43722-0H | 22 | H-51413W/H-51413WHV | 12 | H-71102W-CAN | 18, 23 | H-81702 | 4, 20 |
| H-41416HV-RF375 | 13 | H-43723 | 22 | H-51413WKIT/H-51413WHVKIT | 12 | H-71103W | 18, 23 | H-81702W | 4, 20 |
| H-41416WHV/H-41416WHV | 12 | H-43723-0H | 22 | H-51414/H-51414HV | 12 | H-71103W-CAN | 18, 23 | H-81703 | 4, 20 |
| H-41417HV-RF400 | 13 | H-43724 | 22 | H-51414KIT/H-51414HVKIT | 12 | H-71202W | 18, 23 | H-81703W | 4, 20 |
| H-41417HV-RF475 | 13 | H-43724-0H | 22 | H-51414W/H-51414WHV | 12 | H-71202W-CAN | 18, 23 | H-81704 | 4, 20 |
| H-41417WHV | 12 | H-43725 | 22 | H-51414WKIT/H-51414WHVKIT | 12 | H-71203W | 18, 23 | H-81704W | 4, 20 |
| H-41672 | 15 | H-43726 | 22 | H-51415/H-51415HV | 12 | H-71203W-CAN | 18, 23 | H-81705 | 4, 20 |
| H-41685 | 22 | H-43727 | 22 | H-51415KIT/H-51415HVKIT | 12 | H-74000 | 19 | H-81705W | 4, 20 |
| H-41686 | 22 | H-43814 | 22 | H-51415W/H-51415WHV | 12 | H-74003 | 19 | H-81706 | 4, 20 |
| H-41687 | 22 | H-43817 | 22 | H-51415WKIT/H-51415WHVKIT | 12 | H-74004 | 19 | H-81706W | 4, 20 |
| H-41698 | 22 | H-43900 | 22 | H-51416/H-51416HV | 12 | H-74005 | 19 | H-81707 | 4, 20 |
| H-41699 | 22 | H-43901 | 22 | H-51416HV-RF375 | 13 | H-74006 | 19 | H-81707W | 4, 20 |
| H-41700 | 20 | H-43902 | 22 | H-51416W/H-51416WHV | 12 | H-74007 | 19 | H-81708W | 4, 20 |
| H-41700W | 20 | H-43903 | 22 | H-51417HV-RF400 | 13 | H-74102W | 18 | H-81709W | 4, 20 |
| H-41701 | 20 | H-43904 | 22 | H-51417HV-RF475 | 13 | H-74102W-CAN | 18 | H-81710W | 4, 20 |
| H-41701W | 20 | H-43905 | 22 | H-51417WHV | 12 | H-74103W | 18 | H-84443WPR | 5, 16 |
| H-41702 | 20 | H-43906 | 22 | H-51702 | 20 | H-74103W-CAN | 18 | H-84443WPR2 | 5, 16 |
| H-41702SSL | 20 | H-43907 | 22 | H-51702SSL | 20 | H-74104W | 18 | H-84443WPR3 | 5, 17 |
| H-41702SSW | 20 | H-44443WCOM | 17 | H-51702SSW | 20 | H-74104W-CAN | 18 | H-84443WPR-LF | 5, 16 |
| H-41702T | 20 | H-44443WPR | 16 | H-51702T | 20 | H-74202W | 18 | H-84444WPR | 5, 16 |
| H-41702W | 20 | H-44443WPR2 | 16 | H-51702W | 20 | H-74202W-CAN | 18 | H-84444WPR2 | 5, 16 |
| H-41702WSSL | 20 | H-44443WPR3 | 17 | H-51702WSSL | 20 | H-74203W | 18 | H-84444WPR3 | 5, 17 |
| H-41702WSSW | 20 | H-44443WPR-LF | 16 | H-51702WSSW | 20 | H-74203W-CAN | 18 | H-84444WPR-LF | 5, 16 |
| H-41702WT | 20 | H-44444PR3 | 17 | H-51702WT | 20 | H-74204W | 18 | H-84613 | 5, 14 |
| H-41703 | 20 | H-44444WPR | 16 | H-51703 | 20 | H-74204W-CAN | 18 | H-84614 | 5, 14 |
| H-41703SSL | 20 | H-44444WPR2 | 16 | H-51703SSL | 20 | H-74401W | 18 | H-88613 | 5, 15 |
| H-41703SSW | 20 | H-44444WPR3 | 17 | H-51703SSW | 20 | H-75003 | 19 | H-88614 | 5, 15 |
| H-41703T | 20 | H-44444WPR-LF | 16 | H-51703T | 20 | H-75004 | 19 | H-88615 | 5, 15 |
| H-41703W | 20 | H-45443WCOM | 17 | H-51703W | 20 | H-75005 | 19 | H-88616 | 5, 15 |
| H-41703WSSL | 20 | H-45443WPR | 16 | H-51703WSSL | 20 | H-75006 | 19 | H-88643 | 5, 15 |
| H-41703WSSW | 20 | H-45443WPR2 | 16 | H-51703WSSW | 20 | H-75007 | 19 | H-88644 | 5, 15 |
| H-41703WT | 20 | H-45443WPR3 | 17 | H-51703WT | 20 | H-75102W | 18 | H-88654 | 5, 15 |
| H-41704 | 20 | H-48613 | 15 | H-51704 | 20 | H-75102W-CAN | 18 | H-88655 | 5, 15 |
| H-41704SSL | 20 | H-48614 | 15 | H-51704SSL | 20 | H-75103W | 18 | H-90613W | 6 |
| H-41704SSW | 20 | H-48615 | 15 | H-51704SSW | 20 | H-75103W-CAN | 18 | H-90614W | 6 |
| H-41704T | 20 | H-48616 | 15 | H-51704T | 20 | H-75104W | 18 | H-90615W | 6 |
| H-41704W | 20 | H-50312W | 21 | H-51704W | 20 | H-75104W-CAN | 18 | H-90616W | 6 |
| H-41704WSSL | 20 | H-50313W | 21 | H-51704WSSL | 20 | H-75202W | 18 | H-90617W | 6 |
| H-41704WSSW | 20 | H-50402/H-50402HV | 12 | H-51704WSSW | 20 | H-75202W-CAN | 18 | H-91403WHV | 6 |
| H-41704WT | 20 | H-50403/H-50403HV | 12 | H-51704WT | 20 | H-75203W | 18 | H-91404WHV | 6 |
| H-41705 | 20 | H-50404/H-50404HV | 12 | H-51705 | 20 | H-75203W-CAN | 18 | H-91405WHV | 6 |
| H-41705SSL | 20 | H-50405/H-50405HV | 12 | H-51705SSL | 20 | H-75204W | 18 | H-91406WHV | 6 |
| H-41705W | 20 | H-50406/H-50406HV | 12 | H-51705W | 20 | H-75204W-CAN | 18 | H-91407WHV | 6 |
| H-41705WSSL | 20 | H-50407HV | 12 | H-51705WSSL | 20 | H-78003 | 4, 19 | H-91413WHV | 6 |
| H-41706 | 20 | H-50413/H-50413HV | 12 | H-51706 | 20 | H-78004 | 4, 19 | H-91414WHV | 6 |
| H-41706SSL | 20 | H-50413KIT/H-50413HVKIT | 12 | H-51706SSL | 20 | H-78005 | 4, 19 | H-91415WHV | 6 |
| H-41706W | 20 | H-50414/H-50414HV | 12 | H-51706W | 20 | H-78006 | 4, 19 | H-91416WHV | 6 |
| H-41706WSSL | 20 | H-50414KIT/H-50414HVKIT | 12 | H-51706WSSL | 20 | H-78007 | 4, 19 | H-91417WHV | 6 |
| H-41707 | 20 | H-50415/H-50415HV | 12 | H-51707 | 20 | H-78102W | 4, 18 | H-91702W | 6, 20 |
| H-41707SSL | 20 | H-50415KIT/H-50415HVKIT | 12 | H-51707SSL | 20 | H-78102W-CAN | 4, 18 | H-91703W | 6, 20 |
| H-41707W | 20 | H-50416/H-50416HV | 12 | H-51707W | 20 | H-78103W | 4, 18 | H-91704W | 6, 20 |
| H-41707WSSL | 20 | H-50417HV | 12 | H-51707WSSL | 20 | H-78103W-CAN | 4, 18 | H-91705W | 6, 20 |
| H-41708 | 20 | H-50433 | 14 | H-51708 | 20 | H-78104W | 4, 18 | H-91706W | 6, 20 |
| H-41708W | 20 | H-50433W | 14 | H-51708W | 20 | H-78104W-CAN | 4, 18 | H-91707W | 6, 20 |
| H-41709 | 20 | H-50434 | 14 | H-51709 | 20 | H-78202W | 4, 18 | H-94702W | 6, 20 |
| H-41709W | 20 | H-50434W | 14 | H-51709W | 20 | H-78202W-CAN | 4, 18 | H-94703W | 6, 20 |
| H-41710 | 20 | H-50435 | 14 | H-51710 | 20 | H-78203W | 4, 18 | H-94704W | 6, 20 |
| H-41710W | 20 | H-50435W | 14 | H-51710W | 20 | H-78203W-CAN | 4, 18 | H-94705W | 6, 20 |
| H-41722 | 21 | H-50436 | 14 | H-54443WCOM | 17 | H-78204W | 4, 18 | H-94706W | 6, 20 |
| H-41723 | 21 | H-50436W | 14 | H-54443WPR | 16 | H-78204W-CAN | 4, 18 | H-94707W | 6, 20 |
| H-41724 | 21 | H-50443W | 16 | H-54443WPR2 | 16 | H-80312W | 4, 21 | H-100613W | 7 |
| H-41725 | 21 | H-50443WCOM | 17 | H-54443WPR3 | 17 | H-80313W | 4, 21 | H-100614W | 7 |
| H-41726 | 21 | H-50443WPR | 16 | H-54443WPR-LF | 16 | H-80433W | 5, 14 | H-100615W | 7 |
| H-41727 | 21 | H-50443WPR2 | 16 | H-54444WPR | 16 | H-80434W | 5, 14 | H-100616W | 7 |
| H-41820 | 21 | H-50612 | 14 | H-54444WPR2 | 16 | H-80435W | 5, 14 | H-100617W | 7 |
| H-41820W | 21 | H-50612W | 14 | H-54444WPR3 | 17 | H-80436W | 5, 14 | H-101403WHV | 7 |
| H-41821 | 21 | H-50613 | 14 | H-54612 | 14 | H-80612 | 5, 14 | H-101404WHV | 7 |
| H-41821W | 21 | H-50613W | 14 | H-54612W | 14 | H-80612W | 5, 14 | H-101405WHV | 7 |
| H-41822 | 21 | H-50614 | 14 | H-54613 | 14 | H-80613 | 5, 14 | H-101406WHV | 7 |
| H-41822W | 21 | H-50614W | 14 | H-54613W | 14 | H-80613W | 5, 14 | H-101407WHV | 7 |
| H-41823 | 21 | H-50615 | 14 | H-54614 | 14 | H-80614 | 5, 14 | H-101413WHV | 7 |
| H-41823W | 21 | H-50615W | 14 | H-54614W | 14 | H-80614W | 5, 14 | H-101414WHV | 7 |
| H-41824 | 21 | H-50616 | 14 | H-55443WCOM | 17 | H-80615 | 5, 14 | H-101415WHV | 7 |
| H-41824W | 21 | H-50616W | 14 | H-55443WPR | 16 | H-80615W | 5, 14 | H-101416WHV | 7 |
| H-41825 | 21 | H-50617 | 14 | H-55443WPR2 | 16 | H-80616W | 5, 14 | H-101417WHV | 7 |
| H-41825W | 21 | H-50617W | 14 | H-55443WPR3 | 17 | H-80617W | 5, 14 | H-101702W | 7, 20 |
| H-41826 | 21 | H-50622W | 21 | H-58613 | 15 | H-80672W | 5, 15 | H-101703W | 7, 20 |
| H-41826W | 21 | H-50623W | 21 | H-58614 | 15 | H-80673W | 5, 15 | H-101704W | 7, 20 |
| H-41827 | 21 | H-50624W | 21 | H-58615 | 15 | H-80674W | 5, 15 | H-101705W | 7, 20 |
| H-41827W | 21 | H-50627W | 21 | H-58616 | 15 | H-80675W | 5, 15 | H-101706W | 7, 20 |
| H-41828 | 21 | H-50673W | 15 | H-58643 | 15 | H-81403HV | 4, 12 | H-101707W | 7, 20 |
| H-41828W | 21 | H-50674W | 15 | H-58644 | 15 | H-81404HV | 4, 12 | H-104702W | 7, 20 |
| H-41829 | 21 | H-50675W | 15 | H-58653 | 15 | H-81405HV | 4, 12 | H-104703W | 7, 20 |
| H-41829W | 21 | H-50676W | 15 | H-58654 | 15 | H-81406HV | 4, 12 | H-104704W | 7, 20 |
| H-41830 | 21 | H-50677W | 15 | H-58655 | 15 | H-81406HV-RF375 | 4, 13 | H-104705W | 7, 20 |
| H-41830W | 21 | H-50682 | 21, 23 | H-62023W-18 | 8 | H-81407HV | 4, 12 | H-104706W | 7, 20 |
| H-43702 | 22 | H-51403/H-51403HV | 12 | H-62023W-18-B | 8 | H-81407HV-RF400 | 4, 13 | H-104707W | 7, 20 |
| H-43703 | 22 | H-51403W/H-51403WHV | 12 | H-62033W-18 | 8 | H-81407HV-RF475 | 4, 13 | H-SE-91413 | 6, 7 |
| H-43704 | 22 | H-51404/H-51404HV | 12 | H-62033W-18-B | 8 | H-81413HV | 4, 12 | H-SE-91414 | 6, 7 |
| H-43705 | 22 | H-51404W/H-51404WHV | 12 | H-62702W | 8, 20 | H-81413HVKIT | 12 | H-SE-91415 | 6, 7 |
| H-43706 | 22 | H-51405/H-51405HV | 12 | H-62702W-B | 8, 20 | H-81414HV | 4, 12 | H-SE-91416 | 6, 7 |
| H-43707 | 22 | H-51405W/H-51405WHV | 12 | H-62703W | 8, 20 | H-81414HVKIT | 12 | H-SE-91702 | 6, 7 |
| H-43710 | 22 | H-51406/H-51406HV | 12 | H-62703W-B | 8, 20 | H-81415HV | 4, 12 | H-SE-91704 | 6, 7 |
| H-43712 | 22 | H-51406HV-RF375 | 13 | H-62704W | 8, 20 | H-81415HVKIT | 12 | H-SE-91705 | 6, 7 |
| H-43713 | 22 | H-51406W/H-51406WHV | 12 | H-62704W-B | 8, 20 | H-81416HV | 4, 12 | H-SE-91706 | 6, 7 |
| H-43714 | 22 | H-51407HV-RF400 | 13 | H-64443WPR | 16 | H-81416HV-RF375 | 4, 13 | H-SE-91707 | 6, 7 |